

TURNUP

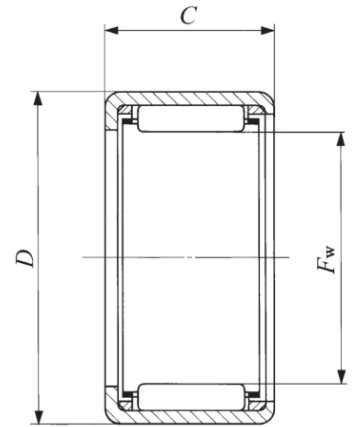

NEEDLE BEARING CATALOG

Index

General Explanation

Characteristics of Needle Roller Bearings	A 3
Types and Features of Bearings	A 5
Outline of Bearing Selection	A16
Basic Dynamic Load Rating and Life	A17
Basic Static Load Rating and Static Safety Factor	A21
Calculation of Bearing Loads	A22
Boundary Dimensions and Identification Number	A26
Accuracy	A30
Clearance	A37
Fit	A39
Design of Shaft and Housing	A44
Lubrication	A49
Friction and Allowable Rotational Speed	A56
Operating Temperature Range	A57
Handling of Bearings	A57

Description of Each Series & Table of Dimensions

Shell Type Needle Roller Bearings	TA · TLA · BA · BHA	B 1
Needle Roller Cages for general usage	KT	C 1
Needle Roller Cages for engine connecting rods	KT · EG · KTV · EG	C17
Machined Type Needle Roller Bearings	NA · TAFI · TRI · BRI	D 1
Needle Roller Bearings with separable cage	NAF	D93
Roller Bearings	NAG · NAU · TRU · NAS	E 1
Thrust Bearings	NTB · AS · AZK · WS · GS	F 1
Combined Type Needle Roller Bearings	NAX · NBX · NATA · NATB	G 1
Inner Rings	IRT · IRB · LRT · LRB	H 1
Cam Followers	CF · NUCF · CFS · CR	I 1
Roller Followers	NAST · NART · NURT	I 83
Crossed Roller Bearings	CRBH · CRBC · CRB · CRBS	J 1
Spherical Bushings	SB · GE · SBB	K 1
Pilloballs	PB · PHS · POS · PHSB · POSB · PHSA	K29
L-balls	LHSA · LHS	K45
Super Flexible Nozzles	SNA · SNM · SNPT	K55
Parts For Needle Roller Bearings	OS · DS · WR · AR · Needle Roller	L 1

Applications Miscellaneous Tables

Presentation of Linear Motion Rolling Guide and Mechatronics Series

Alphabetical Index



General Explanation

Needle roller bearings are bearings for rotary motion that incorporate needle-shaped thin rollers instead of ordinary bearing balls or rollers. Compared with other rolling bearings, they are small-sized and lightweight but have a large load capacity. They are widely used with high reliability in the fields of automobiles, industrial machinery, OA equipment, etc. as resource-saving type bearings that make the whole machine compact.

Characteristics of Needle Roller Bearings

Bearings can be classified into two main types, namely rolling bearings and sliding bearings. Rolling bearings can be subdivided further into ball bearings and roller bearings according to the rolling elements. Needle Roller Bearings are high-precision rolling bearings with a low sectional height, incorporating needle rollers as the rolling element. They have the following features.

Merits of Rolling Bearings

Compared with sliding bearings, rolling bearings have the following merits:

1 Static and kinetic friction is low.

Since the difference between static friction and kinetic friction is small and the frictional coefficient is also small, drive units or machines can be made more compact and lightweight, saving machine costs and power consumption.

2 Stable accuracy can be maintained for long periods.

Owing to less wear, stable accuracy can be maintained for long periods.

3 Machine reliability is improved.

Since the bearing life can be estimated based on rolling fatigue, machine reliability is improved.

4 Lubrication is simplified.

Since grease lubrication is sufficient in most cases, lubrication can be simplified for easy maintenance.

Merits of Needle Roller Bearings

Compared with other rolling bearings, Needle Roller Bearings have the following advantages:

1 With a low sectional height, they can withstand heavy loads.

Since they have a low sectional height compared with other rolling bearings and yet can withstand heavy loads, machines can be made more compact and lightweight, thus saving costs.

2 Rotating torque is small, improving mechanical efficiency.

Since the rotating radius is small, the rotating torque is also small under the same frictional conditions, thus improving mechanical efficiency.

3 Inertia is minimized.

Since the bearing volume and weight are small, the moment of inertia of the bearing is minimized when it is put in motion.

4 Most suited to oscillating motions.

Many rolling elements are arranged at a small spacing pitch, and this configuration is most suited to oscillating motions.

Classification of bearings

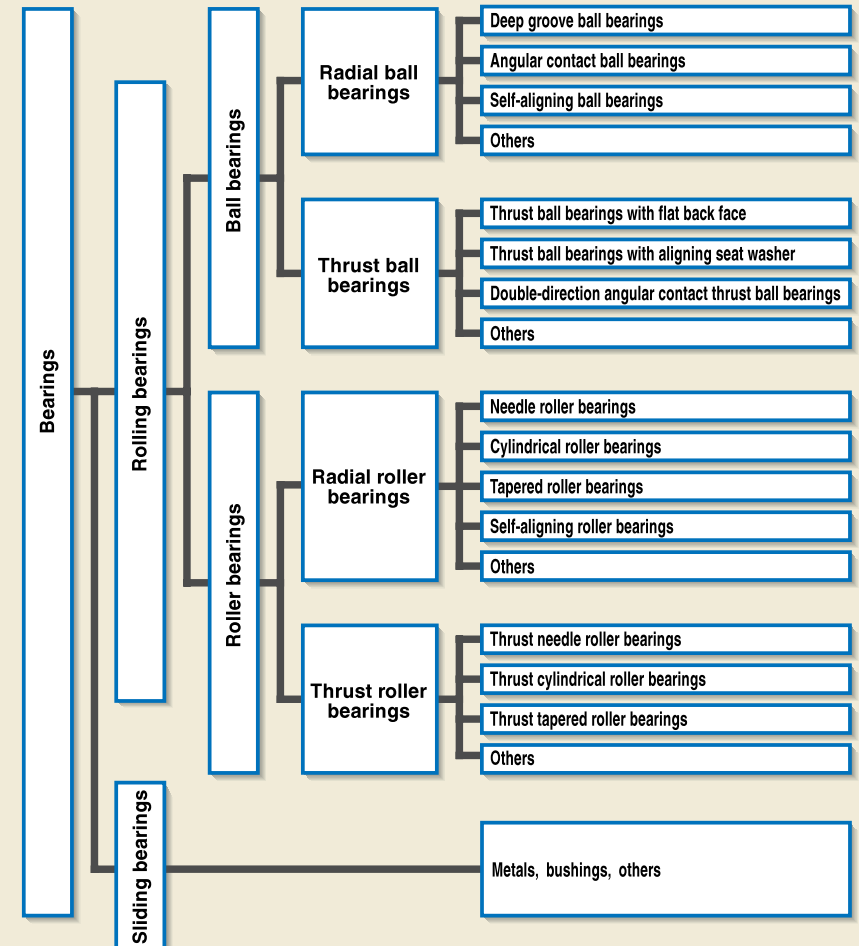

Types and Features of Bearings

Bearings can be roughly classified into radial bearings and thrust bearings according to applicable load direction. Radial Bearings are grouped into Shell Type Needle Roller Bearings, Machined Type Needle Roller Bearings, and various other types. Thrust Bearings are grouped into Thrust Needle Roller Bearings and Thrust Roller Bearings. Follower Bearings that are used for cam mechanisms and linear motion are grouped into Cam Followers and Roller Followers.

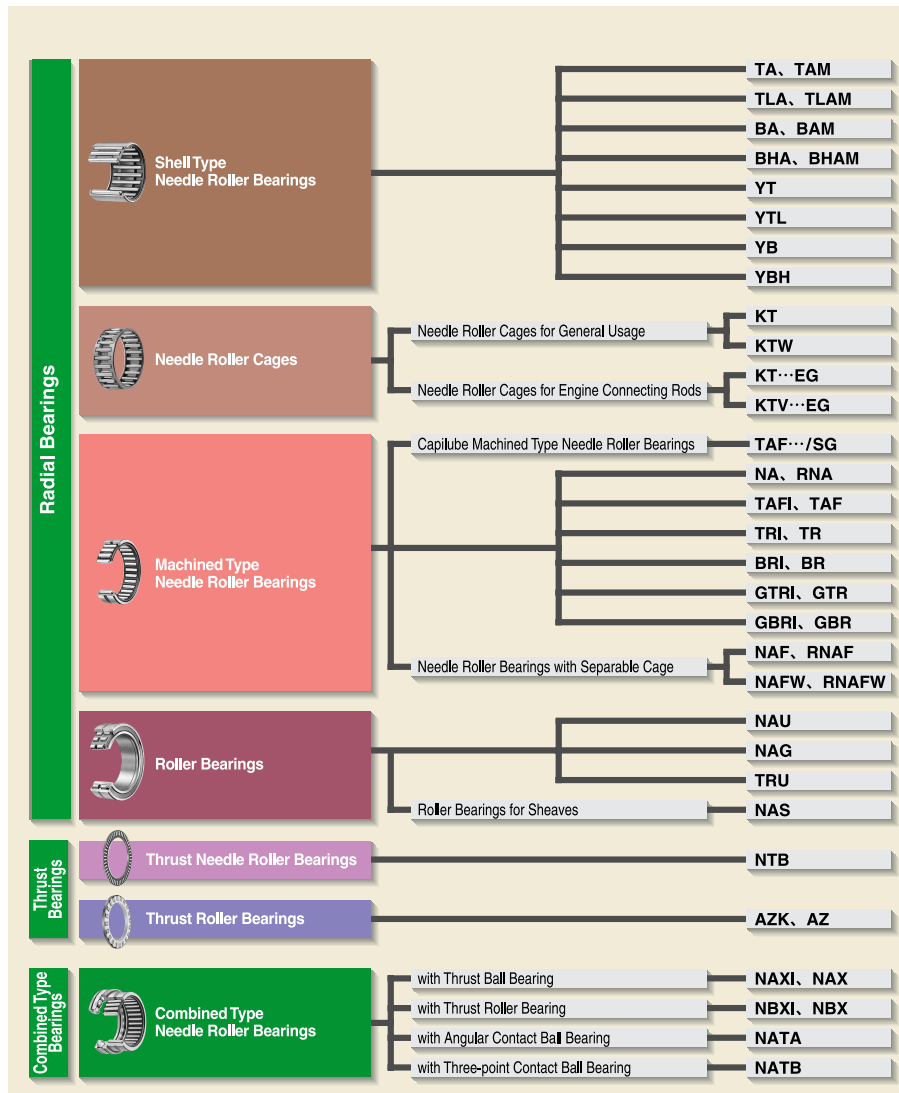

Crossed Roller Bearings are special shape bearings that can simultaneously receive loads in all directions with a single bearing. Bearings other than rolling bearings, such as self-aligning Spherical Bushings that can support radial loads and axial loads and PILLOBALLs and L-Balls that are used for link mechanisms, are also available.

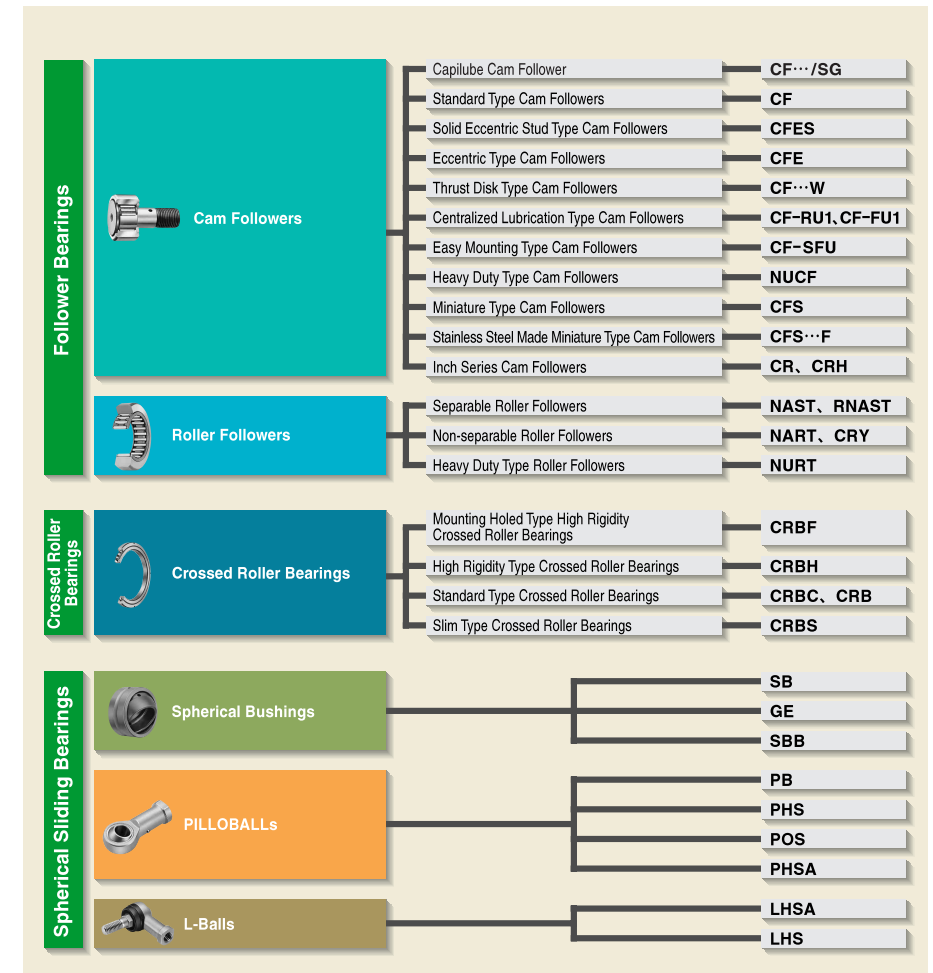

Shell Type Needle Roller Bearings



Shell Type Needle Roller Bearings are lightweight with the lowest sectional height among needle roller bearings with outer ring, because they employ a shell type outer ring made from a thin special-steel plate which is accurately drawn, carburized and quenched. Since these bearings are press-fitted into the housing, no axial positioning fixtures are required. They are ideal for use in mass-produced articles that require economy.

Radial Bearings Page B1

Needle Roller Cages for General Usage



Needle Roller Cages for General Usage are bearings that display excellent rotational performance. Their specially shaped cages with high rigidity and accuracy, precisely guide the needle rollers. Since needle rollers with extremely small dimensional variations in diameter are incorporated and retained, Needle Roller Cages for General Usage are useful in small spaces when combined with shafts and housing bores that are heat treated and accurately ground as raceway surfaces.

Radial Bearing Page C1

Needle Roller Cages for Engine Connecting Rods

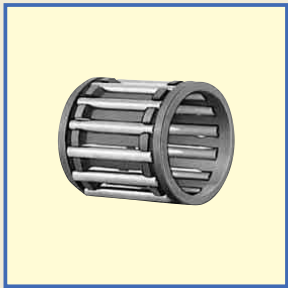

Needle Roller Cages for Engine Connecting Rods are used for motor cycles, small motor vehicles, outboard marines, snow mobiles, general-purpose engines, high-speed compressors, etc. that are operated under extremely severe and complex operating conditions such as heavy shock loads, high speeds, high temperatures, and stringent lubrication. Needle Roller Cages for Engine Connecting Rods are lightweight and have high load ratings and high rigidity as well as superior wear resistance.

Radial Bearing Page C17



Machined Type Needle Roller Bearings have an outer ring made by machining, heat treatment, and grinding. The outer ring has stable high rigidity and can be easily used even for light alloy housings. These bearings are available in various types and optimally selectable for different conditions such as heavy loads, high-speed rotation and low-speed rotation. They are most suitable for general-purpose applications.

Radial Bearing Page D1

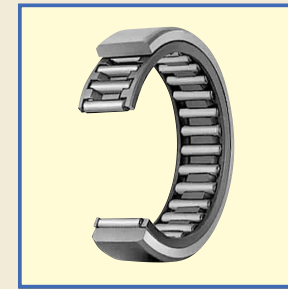

In Needle Roller Bearings with Separable Cage, the inner ring, outer ring and Needle Roller Cage are combined, and they can be separated easily. This type has a simple structure with high accuracy. In addition, the radial clearance can be freely selected by choosing an assembly combination. These bearings have excellent rotational performance, because Needle Roller Cages are used.

Radial Bearing Page D93



Roller Bearings, in which rollers are incorporated in double rows, are non-separable heavy-duty bearings. They can withstand not only radial loads but axial loads as well, which are supported at the contacts between the shoulders of inner and outer rings and the end faces of rollers. Therefore, they are most suitable for use at the fixing side of a shaft.

Radial Bearing Page E1

Thrust Bearings

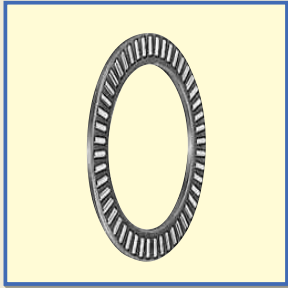

Thrust Bearings consist of a precisely made cage and rollers, and can receive axial loads. They have high rigidity and high load capacities and can be used in small spaces. Thrust Needle Roller Bearings use needle rollers, while Thrust Roller Bearings use cylindrical rollers.

Thrust Bearing Page F1

Cam Followers

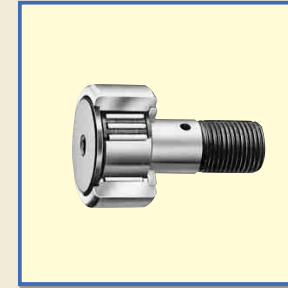

Cam Followers are bearings with a stud incorporating needle rollers in a thick walled outer ring. They are designed for outer ring rotation, and the outer rings run directly on mating track surfaces. Various types of Cam Followers are available. They are widely used as follower bearings for cam mechanisms and for linear motions.

Follower Bearing Page I1

Combined Type Needle Roller Bearings

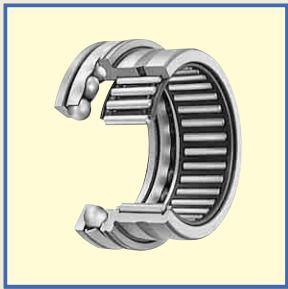

Combined Type Needle Roller Bearings are combinations of a radial bearing and a thrust bearing. Caged Needle Roller Bearings are used as radial bearings and Thrust Ball Bearings or Thrust Roller Bearings are used as thrust bearings. They can be subjected to radial loads and axial loads simultaneously.

Combined Type Bearing Page G1

Roller Followers

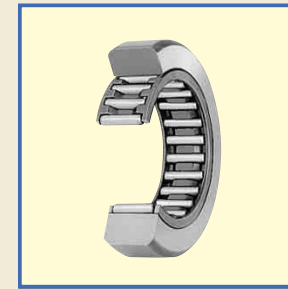

Roller Followers are bearings in which needle rollers are incorporated in a thick walled outer ring. These bearings are designed for outer ring rotation, and the outer rings run directly on mating track surfaces. They are used as follower bearings for cam mechanisms and for linear motions.

Follower Bearing Page I83



Inner Rings are heat-treated and finished by grinding to a high degree of accuracy and are used for Needle Roller Bearings. In the case of Needle Roller Bearings, normally the shafts are heat-treated and finished by grinding and used as raceway surfaces. However, when it is impossible to make shaft surfaces according to the specified surface hardness or surface roughness, Inner Rings are used.

Component part Page H1



Crossed Roller Bearings are high-rigidity and compact bearings with their cylindrical rollers alternately crossed at right angles to each other between inner and outer rings. A single Crossed Roller Bearing can take loads from any directions at the same time such as radial, thrust, and moment loads. These bearings are widely used in the rotating parts of industrial robots, machine tools, medical equipment, etc. which require compactness, high rigidity and high rotational accuracy.

Crossed Roller Bearing Page J1

Spherical Bushings

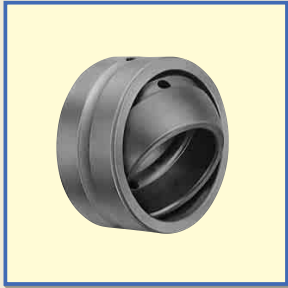

Spherical Bushings are self-aligning spherical plain bushings, which have inner and outer rings with spherical sliding surfaces. They can take a large radial load and a bi-directional axial load at the same time. They are divided into steel-on-steel types that are suitable for applications where there are alternate loads or shock loads, and maintenance-free types which require no lubrication.

Spherical Sliding Bearing Page K1

Seals for Needle Roller Bearings

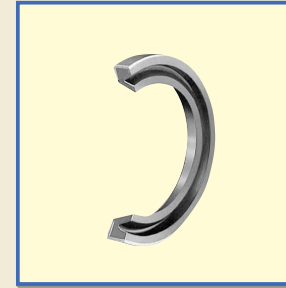

Seals for Needle Roller Bearings have a low sectional height and consist of a sheet metal ring and special synthetic rubber. As these seals are manufactured to the same sectional height as Needle Roller Bearings, grease leakage and the penetration of foreign particles can be effectively prevented by fitting them directly to the sides of combinable bearings.

Component Part Page L1

PILLOBALLS



PILLOBALLS are compact self-aligning spherical plain bushings which can support a large radial load and a bi-directional axial load at the same time. PILLOBALL Rod Ends have either a female thread in the body or a male thread on the body, so they can be easily assembled onto machines. PILLOBALLS are used in control and link mechanisms in machine tools, textile machines, packaging machines, etc.

Spherical Sliding Bearing Page K29

Cir-clips for Needle Roller Bearings

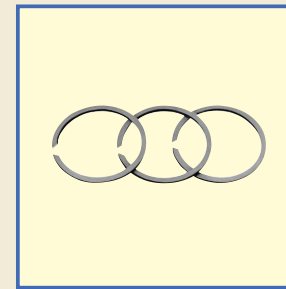

Cir-clips for Needle Roller Bearings have been specially designed for needle roller bearings on which, in many cases, generally available Cir-clips cannot be used. They have a low sectional height and are very rigid. There are Cir-clips for shafts and for bores, and they are used for positioning to prevent bearing movement in the axial direction.

Component Part Page L17

L-Balls



L-Balls are self-aligning rod-ends consisting of a special die-cast zinc alloy body and a studded ball which has its axis at right-angles to the body. They can perform tilting movement and rotation with low torque, and transmit power smoothly due to the uniform clearance between the sliding surfaces. They are used in link mechanisms in automobiles, construction machinery, farm and packaging machines, etc.

Spherical Sliding Bearing Page K45

Needle Rollers

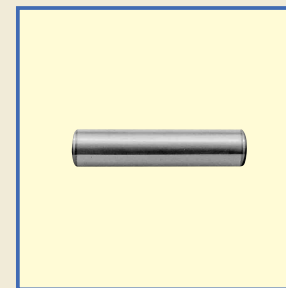

Needle Rollers are used for needle roller bearings and are rigid and highly accurate. These needle rollers are widely used as rolling elements for bearings, and also as pins and shafts.

Component Part Page L23

Bearing series		Appearance	Direction of motion	Load direction and capacity	Allowable rotational speed	Friction	Sectional height	Reference page
Shell Type Needle Roller Bearings	Caged type							B1 ~
	Full complement type							
Needle Roller Cages	For general usage							C1 ~
	For engine connecting rods							C17 ~
Machined Type Needle Roller Bearings	Caged type							D1 ~
	Full complement type							
Needle Roller Bearings with Separable Cage	Caged type							D93 ~
Roller Bearings	Caged type							E1 ~
	Full complement type							
	For sheaves							

Symbol Rotation Oscillating motion Radial load Axial load Light load Medium load Heavy load Especially excellent Excellent Normal

Bearing series		Appearance	Direction of motion	Load direction and capacity	Allowable rotational speed	Friction	Sectional height	Reference page
Thrust Bearings	Needle roller bearings							F1 ~
	Roller bearings							
Combined Type Needle Roller Bearings	With thrust ball bearing							G1 ~
	With thrust roller bearing							
	With angular contact ball bearing							
	With three-point contact ball bearing							
Cam Followers	Caged type							I1 ~
	Full complement type							
Roller Followers	Separable caged type							I83 ~
	Non-separable caged type							
	Non-separable full complement type							

Bearing series		Appearance	Direction of motion	Load direction and capacity	Allowable rotational speed	Friction	Sectional height	Reference page
Crossed Roller Bearings	Caged type, Separator type							J1 ~
	Full complement type							
	Slim type							
Spherical Bushings	Steel-on-steel type							K1 ~
	Maintenance-free type							
PILLOBALLS	Insert type, Lubrication type							K29 ~
	Die-casting type, Lubrication type							
	Maintenance-free type							
L-Balls	Lubrication type							K45 ~

Symbol Rotation Oscillating motion Radial load Axial load Light load Medium load Heavy load Especially excellent Excellent Normal

Outline of Bearing Selection

Bearings are available in many types and sizes. To obtain satisfactory bearing performance in machines and equipment, it is essential to select the most suitable bearing by carefully studying the requirements for the application. Although there is no particular procedure or rule for bearing selection, an example of a commonly adopted procedure is shown in the figure below.

An example of procedure for bearing selection



Basic Dynamic Load Rating and Life

Life

Rolling bearings will suffer damage due to various causes during service. Damage such as abnormal wear, seizure, and cracks is caused by improper use, including incorrect mounting, lack of oil, dust intrusion and so on, and can be avoided by remedying these causes. However, bearings will eventually be damaged due to fatigue-flaking even if used properly. When a bearing rotates under load, the raceways and the rolling elements are subjected to repeated stresses concentrated on the part close to the surface. Fatigue, therefore, occurs in the surface layer, producing damage in the form of scaling. This is called flaking (spalling). When this occurs, the bearing can no longer be used.

Bearing Life

Bearing life is defined as the total number of revolutions (or total service hours at a constant rotational speed) before a sign of the first flaking appears on the rolling surface of raceway or rolling elements. However, even when bearings of the same size, structure, material and heat treatment are subjected to the same conditions, the bearing lives will show variation (See Fig. 1.). This results from the statistical nature of the fatigue phenomenon.

In selecting a bearing, it is incorrect to take an average life for all bearings as the design standard. It is more practical to consider a bearing life that is reliable for the greater proportion of bearings used. Therefore, the basic rating life defined in the following is used.

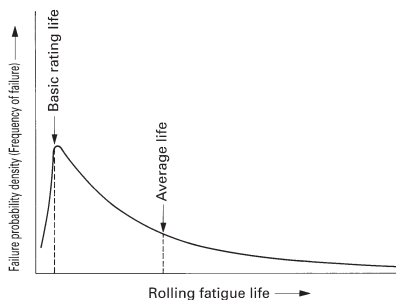

Fig. 1 Variation of rolling fatigue life

Basic rating life

The basic rating life is defined as the total number of revolutions that 90% of a group of identical bearings can be operated individually under the same conditions free from any material damage caused by rolling fatigue.

For rotation at a constant rotational speed, the basic rating life can be represented by the total service hours.

Basic dynamic load rating

The basic dynamic load rating is defined as the constant radial load (in the case of radial bearings) or the constant axial load acting along the bearing central axis (in the case of thrust bearings) that allows a basic rating life of 1,000,000 revolutions.

Calculation of rating life

The relationship among the basic rating life, basic dynamic load rating and dynamic equivalent load (bearing load) of rolling bearings is as follows:

$$L_{10} = \left(\frac{C}{P}\right)^p \dots\dots\dots (1)$$

- where, L_{10} : Basic rating life, 10^6 rev.
- C : Basic dynamic load rating, N
- P : Dynamic equivalent load, N
- p : Exponent, Roller bearing: 10/3
Ball bearing: 3

Accordingly, when the rotational speed per minute is given, the basic rating life is represented as the total service hours according to the following equations:

$$L_h = \frac{10^6 L_{10}}{60n} = 500 f_h^p \dots\dots\dots (2)$$

$$f_h = f_n \frac{C}{P} \dots\dots\dots (3)$$

$$f_n = \left(\frac{33.3}{n}\right)^{1/p} \dots\dots\dots (4)$$

- where, L_h : Basic rating life represented by service hours, h
- n : Rotation speed, rpm
- f_h : Life factor
- f_n : Velocity factor

In addition, the rating life can be calculated by obtaining f_h and f_n from the life calculation scales of Fig. 2.

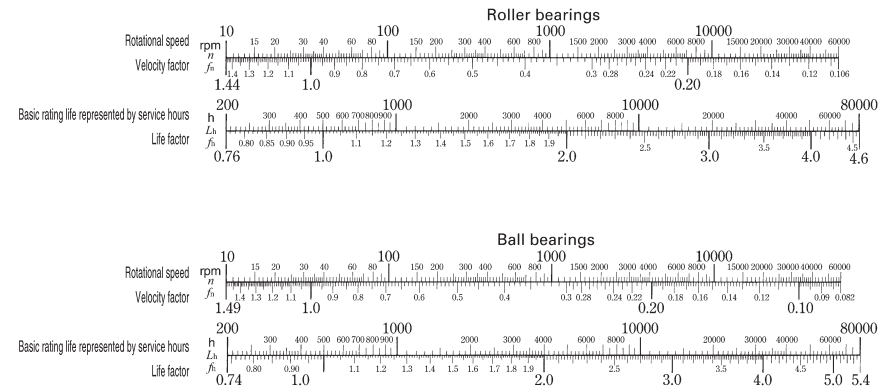

Fig. 2 Scales for rating life calculation

Bearing life factors for various machines

The required life of the bearing must be determined according to the machine in which the bearing is to be used and the operating conditions.

Table 1 shows reference values of life factors for selecting a bearing for each machine.

Table 1 Life factor of bearings f_h for various machines

Operating conditions	Machine and life factor f_h				
	~3	2~4	3~5	4~7	6~
Occasional or short term usage	• Power tools	• Agricultural machines			
Infrequent usage but requiring reliable operation		• Construction machinery	• Conveyors • Elevators		
Intermittent operation but for comparatively long periods	• Roll neck of rolling mills	• Small motors • Deck cranes • General cargo cranes • Passenger cars	• Factory motors • Machine tools • General gear units • Printing machines	• Crane sheaves • Compressors • Important gear units	
Operated in excess of 8 hours per day or continuously for an extended time		• Escalators	• Centrifugal separators • Blowers • Wood working machines • Plastic extruding machines		• Paper making machines
Continuous use for 24 hours and accidental stops not allowed					• Water supply equipment • Power station equipment

1mm=0.03937inch

Life of oscillating bearing

The life of an oscillating bearing can be obtained from equation (5).

$$L_{OC} = \frac{90}{\theta} \left(\frac{C}{P} \right)^p \quad (5)$$

where, L_{OC} : Basic rating life of oscillating bearing, 10^6 cycles

2θ : Oscillating angle, deg. (See Fig.3)

P : Dynamic equivalent load, N

Therefore, when the oscillating frequency n_1 cpm is given, the basic rating life as represented by total oscillating hours can be obtained by substituting n_1 for n in equation (2) on page A17.

When 2θ is small, an oil film cannot be formed easily between the contact surfaces of the raceway and the rolling elements. This may cause fretting corrosion. In this case, please consult

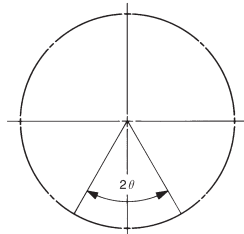

Fig. 3 Oscillating motion

Corrected rating life

When a rolling bearing is used in ordinary applications, the basic rating life can be calculated by equations (1) and (2) mentioned previously.

This basic rating life applies to bearings which require a reliability of 90%, have ordinary bearing properties being made of materials of ordinary quality for rolling bearings, and are used under ordinary operating conditions.

In some applications, however, it is necessary to obtain a rating life that applies to bearings which require high reliability, have special bearing properties or are used under special operating conditions. The corrected rating life for these special cases can be obtained from the following equation by using the

bearing life adjustment factors a_1 , a_2 and a_3 , respectively.

$$L_{na} = a_1 a_2 a_3 L_{10} \quad (6)$$

where, L_{na} : Corrected rating life, 10^6 rev.

a_1 : Life adjustment factor for reliability

a_2 : Life adjustment factor for special bearing properties

a_3 : Life adjustment factor for operating conditions

Life adjustment factor for reliability a_1

The reliability of rolling bearings is defined as the proportion of bearings having a life equal to or greater than a certain specified value when a group of identical bearings are operated under identical conditions. With respect to individual bearings, it refers to the probability of the life of a bearing being equal to or greater than a certain specified value.

The corrected rating life for a reliability of (100-n)% can be obtained using equation (6). Table 2 shows the values of the life adjustment factor a_1 for various reliabilities.

Table 2 Life adjustment factor for reliability a_1

Reliability %	L_n	a_1
90	L_{10}	1
95	L_5	0.62
96	L_4	0.53
97	L_3	0.44
98	L_2	0.33
99	L_1	0.21

Life adjustment factor for special bearing properties a_2

The bearing life is extended or shortened according to the quality of the material, the manufacturing technology of the bearing and its internal design. For these special bearing life properties, the life is corrected by the life adjustment factor for special bearing properties a_2 .

Life adjustment factor for operating condition a_3

This factor helps take into account the effects of operating conditions, especially lubrication on the bearing. The bearing life is limited by the phenomenon of fatigue which occurs, in general, beneath surfaces subjected to repeated stresses. Under good lubrication conditions where the rolling element and raceway surfaces are completely separated by an oil film and surface damage can be disregarded, a_3 is set to be 1. However, when conditions of lubrication are not good, namely, when the viscosity of the lubricating oil is low or the peripheral speed of the rolling elements is especially low, and so on, $a_3 < 1$ is used.

On the other hand, when lubrication is especially good, a value of $a_3 > 1$ can be used. When lubrication is not good and $a_3 < 1$ is used, the life adjustment factor a_2 cannot generally exceed 1.

When selecting a bearing according to the basic dynamic load rating, it is recommended that a suitable value for reliability factor a_1 is chosen for each application. The selection should be made using the (C/P) or f_h values determined by machine type and based upon the actual conditions of lubrication, temperature, mounting, etc., which have already been experienced and observed in the same type of machines.

Limiting conditions

These bearing life equations are applicable only when the bearing is mounted and lubricated normally without intrusion of foreign materials and not used under extreme operating conditions.

Unless these conditions are satisfied, the life may be shortened. For example, it is necessary to separately consider the effects of bearing mounting errors, excessive deformation of housing and shaft, centrifugal force acting on rolling elements at high-speed revolution, excessive preload, especially large radial internal clearance of radial bearings, etc.

When the dynamic equivalent load exceeds 1/2 of the basic dynamic load rating, the life equations may not be applicable.

Correction of basic dynamic load rating for temperature and hardness

Temperature factor

The operating temperature for each bearing is determined according to its material and structure. If special heat treatment is performed, bearings can be used at temperatures higher than $+150^\circ\text{C}$. However, the allowable contact stress decreases gradually as the operating temperature increases. Accordingly, the basic dynamic load rating is lowered and can be obtained by the following equation:

$$C_t = f_t C \quad (7)$$

where, C_t : Basic dynamic load rating considering temperature rise, N

f_t : Temperature factor (See Fig. 4.)

C : Basic dynamic load rating, N

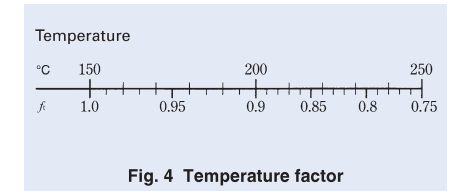

Fig. 4 Temperature factor

Hardness factor

When the shaft or housing is used as the raceway surface instead of the inner or outer ring, the surface hardness of the part used as the raceway surface should be 58~64HRC.

If it is less than 58HRC, the basic dynamic load rating is lowered and can be obtained by the following equation:

$$C_H = f_H C \quad (8)$$

where, C_H : Basic dynamic load rating considering hardness, N

f_H : Hardness factor (See Fig. 5.)

C : Basic dynamic load rating, N

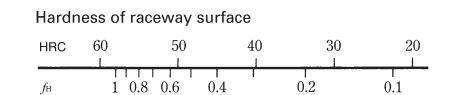

Fig. 5 Hardness factor

Basic Static Load Rating and Static Safety Factor

Basic static load rating

When a bearing at rest sustains a heavy load or a bearing rotating at a relatively low speed receives a heavy shock load, the contact stress may exceed a certain limiting value, producing a local permanent deformation in the raceways or the rolling elements, and subsequently causing noise or vibration or lowering the rotating performance. The basic static load rating is, therefore, determined as a guideline for the maximum allowable load for the bearing at rest, under which the permanent deformation will not exceed a certain limit value, and the lowering of the rotating performance will not occur. Its definition is given as follows.

The basic static load rating is the static load that gives the contact stress shown in Table 3 at the center of the contact area of the rolling element and the raceway receiving the maximum load. A radial load constant in direction and magnitude is used in the case of radial bearings, while an axial load constant in magnitude acting along the bearing central axis is used in the case of thrust bearings.

Table 3

Type of bearing	Contact stress MPa
Roller bearings	4 000
Self-aligning ball bearings	4 600
Other ball bearings	4 200

Static safety factor

The basic static load rating gives the theoretical allowable limit of the static equivalent load. Normally, this limit is corrected by considering the operating conditions and the requirements for the bearing. The correction factor, namely, the static safety factor f_s is defined as in the following equation and its general values are shown in Table 4.

$$f_s = \frac{C_0}{P_0} \quad (9)$$

where, C_0 : Basic static load rating, N
 P_0 : Static equivalent load, N

Table 4 Static safety factor

Operating conditions of the bearing	f_s
When high rotational accuracy is required	≥ 3
For ordinary operation conditions	≥ 1.5
For ordinary operation conditions not requiring very smooth rotation When there is almost no rotation	≥ 1

In case of Shell Type Needle Roller Bearings of which outer ring is drawn from a thin steel plate and then carburized and quenched, it is necessary to use a static safety factor of 3 or more.

Calculation of Bearing Loads

The loads acting on bearings include the weight of the machine parts supported by the bearings, the weight of the rotating body, loads produced when operating the machine, loads by belts or gears transmitting power, and various other loads.

These loads can be divided into radial loads perpendicular to the central axis of the bearings and axial loads parallel to the central axis, and they act independently or in combination with other loads. In addition, the magnitude of vibration or shocks on the bearings varies depending on the application of the machine. Thus, theoretically calculated loads may not always be accurate and have to be corrected by multiplying various empirical factors to obtain the actual bearing loads.

Load distribution to bearings

Table 5 shows examples of calculations where static loads are acting in radial direction.

Table 5 Load distribution to bearings

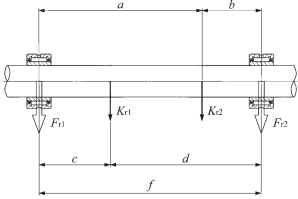
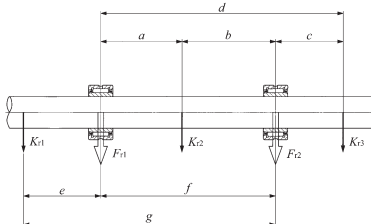
Example	Bearing load
	$F_{r1} = \frac{dK_{r1} + bK_{r2}}{f}$ $F_{r2} = \frac{cK_{r1} + aK_{r2}}{f}$
	$F_{r1} = \frac{gK_{r1} + bK_{r2} - cK_{r3}}{f}$ $F_{r2} = \frac{aK_{r2} + dK_{r3} - eK_{r1}}{f}$

Load factor

Although radial loads and axial loads can be obtained by calculation, it is not unusual for the actual bearing loads to exceed the calculated loads, due to vibration and shocks produced when operating the machine. The actual bearing load is obtained from the following equation, by multiplying the calculated load by the load factor:

$$F = f_w F_c \quad (10)$$

where, F : Bearing load, N
 f_w : Load factor (See Table 6.)
 F_c : Theoretically calculated load, N

Table 6 Load factor

Operating conditions	Example	f_w
Smooth operation without shocks	Electric motors, Air conditioning equipment, Measuring instruments, Machine tools	1 ~ 1.2
Ordinary operation	Reduction gearboxes, Vehicles, Textile machinery, Paper making machinery	1.2 ~ 1.5
Operation subjected to vibration and shocks	Rolling mills, Rock crushers, Construction machinery	1.5 ~ 3

Bearing loads in case of belt or chain transmission

When power is transmitted by a belt or chain, the load acting on the pulley or sprocket wheel is obtained from the following equations:

$$T = 9550000 \frac{H}{n} \quad (11)$$

$$K_t = \frac{T}{R} \quad (12)$$

where, T : Torque acting on pulley or sprocket wheel, N-mm

K_t : Effective transmitting force of belt or chain, N

H : Transmitting power, kW

n : Rotation speed, rpm

R : Effective radius of pulley or sprocket wheel, mm

For belt transmission, the load K_r acting on the pulley shaft is obtained from the following equation, multiplying the effective transmitting force K_t by the belt factor f_b shown in Table 7.

$$K_r = f_b K_t \quad (13)$$

Table 7 Belt factor

Type of belt	f_b
V-belts	2 ~ 2.5
Timing belts	1.3 ~ 2
Plain belts (with tension pulley)	2.5 ~ 3
Plain belts	4 ~ 5

In the case of chain transmission, a value of 1.2 to 1.5 is taken as the chain factor corresponding to f_b . The load acting on the sprocket wheel shaft is obtained from equation (13) in the same manner as the belt transmission.

Bearing loads in case of gear transmission

When power is transmitted by gears, the force acting on the gears varies according to the type of gear. Spur gears produce radial loads only, but helical gears, bevel gears and worm gears produce axial loads in addition to radial loads. Taking the simplest case of spur gears as an example, the bearing load is obtained from the following equations:

$$T = 9550000 \frac{H}{n} \quad (14)$$

$$K_t = \frac{T}{R} \quad (15)$$

$$K_s = K_t \tan \theta \quad (16)$$

$$K_c = \sqrt{K_t^2 + K_s^2} = K_t \sec \theta \quad (17)$$

where, T : Torque applied to gear, N-mm
 K_t : Tangential force acting on gear, N
 K_s : Radial force acting on gear, N
 K_c : Resultant normal force on gear tooth surface, N
 H : Transmitting power, kW
 n : Rotational speed, rpm
 R : Pitch circle radius of drive gear, mm
 θ : Pressure angle of gear, deg.

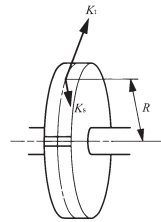

Fig. 6

In this case, the resultant normal force on the tooth surface acts as the radial force to the shaft and the magnitude of vibration or shocks varies depending on the accuracy and surface finish of the gear. Therefore, the radial load K_r applied to the shaft is obtained from the following equation, multiplying the resultant normal force K_c on gear tooth surface by the gear factor f_z shown in Table 8.

$$K_r = f_z K_c \quad (18)$$

Table 8 Gear factor

Type of gear	f_z
Precision gears (Pitch error and form error: Less than 0.02mm)	1.05 ~ 1.1
Ordinary machined gears (Pitch error and form error: 0.02 ~ 0.1mm)	1.1 ~ 1.3

Mean equivalent load corresponding to fluctuating load

When the load applied to the bearing fluctuates, the bearing life is calculated by using the mean equivalent load F_m , which is a constant load that will give the bearing a life equal to that produced under the fluctuating load. The mean equivalent load is obtained from the following equation:

$$F_m = \sqrt[p]{\frac{1}{N} \int_0^N F_n^p dN} \quad (19)$$

where, F_m : Mean equivalent load, N
 N : Total number of revolutions, rev.
 F_n : Fluctuating load, N
 p : Exponent, Roller bearing = 10/3
 Ball bearing = 3

Table 9 shows examples of the calculation of mean equivalent loads for various fluctuating loads.

Table 9 Mean equivalent load for the fluctuation load

Type of fluctuating load	Mean equivalent load F_m
<p>Step load</p>	$F_m = \sqrt[p]{\frac{1}{N} (F_1^p N_1 + F_2^p N_2 + \dots + F_n^p N_n)}$ <p>where, N_1 : Total number of revolutions under load F_1 rev. N_2 : Total number of revolutions under load F_2 rev. N_n : Total number of revolutions under load F_n rev.</p>
<p>Monotonously changing load</p>	$F_m = \frac{1}{3} (2F_{max} + F_{min})$ <p>where, F_{max} : Maximum value of fluctuating load, N F_{min} : Minimum value of fluctuating load, N</p>
<p>Sinusoidally fluctuating load</p>	$F_m \cong 0.65 F_{max}$
<p>Sinusoidally fluctuating load</p>	$F_m \cong 0.75 F_{max}$
<p>Stationary load plus rotating load</p>	$F_m = F_S + F_R - \frac{F_S F_R}{F_S + F_R}$ <p>where, F_S : Stationary load, N F_R : Rotating load, N</p>

$$1N = 0.102 \text{kgf} = 0.2248 \text{lbs.}$$

$$1\text{mm} = 0.03937 \text{inch}$$

Equivalent load

The loads applied to the bearing are divided into radial loads that are applied perpendicular to the central axis and axial loads that are applied in parallel to the central axis. These loads act independently or in combination with other loads.

Dynamic equivalent load

When both radial load and axial load are applied to the bearing simultaneously, the virtual load, acting on the center of the bearing, that will give a life equal to that under the radial load and the axial load is defined as a dynamic equivalent load.

In the case of needle roller bearings, radial bearings receive only radial loads and thrust bearings receive only axial loads. Accordingly, radial loads are directly used for the radial bearings, while axial loads are directly used for the thrust bearings.

[For radial bearings]

$$P_r = F_r \quad \dots\dots\dots(20)$$

[For thrust bearings]

$$P_a = F_a \quad \dots\dots\dots(21)$$

where, P_r : Dynamic equivalent radial load, N
 P_a : Dynamic equivalent axial load, N
 F_r : Radial load, N
 F_a : Axial load, N

Static equivalent load

When both radial load and axial load are applied to the bearing simultaneously, the virtual load, acting on the center of the bearing, that will produce a maximum contact stress on the contact surface between the rolling element and the raceway equal to that given by the radial load and the axial load is defined as a static equivalent load.

In the case of needle roller bearings, radial bearings receive only radial loads and thrust bearings receive only axial loads. Accordingly, radial loads are directly used for the radial bearings, while axial loads are directly used for the thrust bearings.

[For radial bearings]

$$P_{0r} = F_r \quad \dots\dots\dots(22)$$

[For thrust bearings]

$$P_{0a} = F_a \quad \dots\dots\dots(23)$$

where, P_{0r} : Static equivalent radial load, N
 P_{0a} : Static equivalent axial load, N
 F_r : Radial load, N
 F_a : Axial load, N

Boundary Dimensions and Identification Number

Boundary dimensions

Examples of symbols for quantities indicating the boundary dimensions of Needle Roller Bearings are shown below. For details, see the table of dimensions for each model.

Machined Type Needle Roller Bearing

- d : Nominal bearing bore diameter
- D : Nominal bearing outside diameter
- B : Nominal inner ring width
- C : Nominal outer ring width
- F_w : Nominal roller set bore diameter
- r : Chamfer dimensions of inner and outer rings
- $r_{s \min}$: Smallest permissible single chamfer dimensions of inner and outer rings

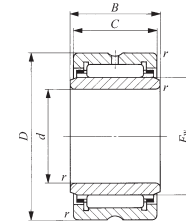

Fig. 7 Machined Type Needle Roller Bearing

Shell Type Needle Roller Bearing

- D : Nominal bearing outside diameter
- F_w : Nominal roller set bore diameter
- C : Nominal outer ring width

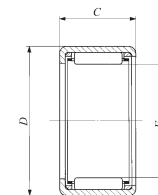

Fig. 8 Shell Type Needle Roller Bearing

Needle Roller Cage

- E_w : Nominal roller set outside diameter
- F_w : Nominal roller set bore diameter
- B_c : Nominal cage width

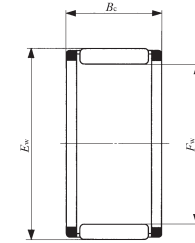

Fig. 9 Needle Roller Cage

Thrust Roller Bearing

- D_c : Nominal cage outside diameter
- d_c : Nominal cage bore diameter
- D_w : Nominal roller diameter

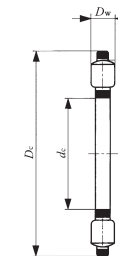

Fig. 10 Thrust Roller Bearing

Identification Number

The identification number of Bearings consists of a model number and supplemental codes. The descriptions of typical codes and their arrangements are shown below. There are many codes other than those described. See the section of identification number of each bearing.

Table 10 Arrangement of identification number of bearing

Model number	Model code	①
	Boundary dimensions	②
Supplemental code	Material symbol	③
	Cage symbol	④
	Shield symbol	⑤
	Seal symbol,	
	Bearing ring shape symbol	⑥
	Clearance symbol	⑦
Classification symbol	⑧	

① Model code

The model code represents the bearing series. The features of each bearing series are shown on pages A5 to A15.

② Boundary dimensions

One of the following four kinds of presentation methods is used for showing boundary dimensions in the identification number, which vary depending on the bearing series. Table 11 shows the presentation methods of boundary dimensions for each model code.

- (a) Dimension series + Bore diameter number
- (b) Bore diameter or roller set bore diameter + Outside diameter or roller set outside diameter + Width
- (c) Bore diameter or roller set bore diameter + Width
- (d) Basic diameter

③ Material symbol

Symbol	Type of material
F	Stainless steel for bearing rings and rolling elements

④ Cage symbol

Symbol	Descriptions
N	Made of synthetic resin
V	No cage or full complement

⑤ Seal or shield symbol

Symbol	Descriptions
Z	With dust cover
ZZ	With shields on both sides
U	With a seal on one side
UU	With seals on both sides
2RS	With seals on both sides

⑥ Bearing ring shape symbol

Symbol	Descriptions
NR	With stop ring on outer surface of outer ring
OH ⁽¹⁾	With oil hole in bearing ring
J	No oil hole

Note⁽¹⁾ This differs depending on the type of bearing. See the section of each bearing.

⑦ Clearance symbol

Symbol	Descriptions
C2	C2 clearance
(None)	CN clearance
C3	C3 clearance
C4	C4 clearance
C5	C5 clearance
T1	Special radial clearance (Applicable to Crossed Roller Bearings)
C1	
C2	

⑧ Classification symbol

Symbol	Descriptions
(None)	JIS Class 0
P6	JIS Class 6
P5	JIS Class 5
P4	JIS Class 4

Table 11 Indication of boundary dimensions

Bearing type	Model number	
	Model code	Indication of boundary dimensions
Shell Type Needle Roller Bearings	TA, TLA, YT, YTL	Roller set bore diameter + Outer ring width
	BA, BHA, YB, YBH	Roller set bore diameter + Outer ring width ⁽¹⁾
Needle Roller Cages for General Usage	KT, KTW	Roller set bore diameter + Roller set outside diameter + Cage width
Needle Roller Cages for Engine Connecting Rods	KT...EG, KTV...EG	Roller set bore diameter + Roller set outside diameter + Cage width
Machined Type Needle Roller Bearings	NA, RNA	Dimension series + Bore diameter number
	TR, TAF, GTR	Roller set bore diameter + Bearing outside diameter + Bearing width
	TRI, TAFI, GTRI	Bearing bore diameter + Bearing outside diameter + Outer ring width
	BR, GBR	Roller set bore diameter + Bearing outside diameter + Bearing width ⁽¹⁾
	BRI, GBRI	Bearing bore diameter + Bearing outside diameter + Outer ring width ⁽¹⁾
Needle Roller Bearings with Separable Cage	RNAF, RNAFW	Roller set bore diameter + Bearing outside diameter + Bearing width
	NAF, NAFW	Bearing bore diameter + Bearing outside diameter + Bearing width
Roller Bearings	NAU, NAG, NAS	Dimension series + Bore diameter number
	TRU	Bearing bore diameter + Bearing outside diameter + Bearing width
Thrust Bearings	NTB, AS, WS, GS	Bearing bore diameter + Bearing outside diameter
	AZ	Bearing bore diameter + Bearing outside diameter + Bearing height
	AZK	Bearing bore diameter + Bearing outside diameter + Roller diameter
Combined Type Needle Roller Bearings	NAX, NBX	Roller set bore diameter + Assembled bearing width
	NAXI, NBXI	Innerring bore diameter + Assembled bearing width
	NATA, NATB	Dimensional series + Bore diameter number
Cam Followers	CF, NUCF, CFS	Stud diameter
	CR, CRH	Bearing outside diameter ⁽¹⁾
Roller Followers	NAST, NART, NURT	Bearing bore diameter
	CRY	Bearing outside diameter ⁽¹⁾
Crossed Roller Bearings	CRBH, CRB, CRBS	Bearing bore diameter + Bearing width
Spherical Bushings	SB...A, GE	Inner ring bore diameter
	SBB	Inner ring bore diameter ⁽¹⁾
PILLOBALLs	PB,PHS,POS,PHSB,POSB,PHSA	Inner ring bore diameter
L-Balls	LHSA, LHS	Screw size
Seals for Needle Roller Bearings	OS, DS	Shaft diameter + Seal outside diameter + Seal width
Cir-clips for Needle Roller Bearings	WR	Shaft diameter
	AR	Bore diameter

Note⁽¹⁾ The nominal dimensions of inch series bearings are indicated in units of 1/16 inch.

Example of identification number

(a) Example of "Dimension series + Bore diameter number"

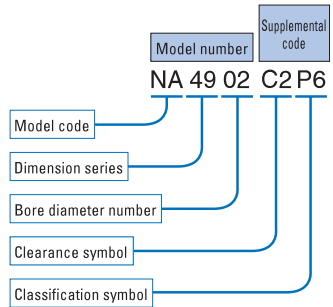

(b) Example of "Bore diameter or roller set bore diameter + Outside diameter or roller set outside diameter + width"

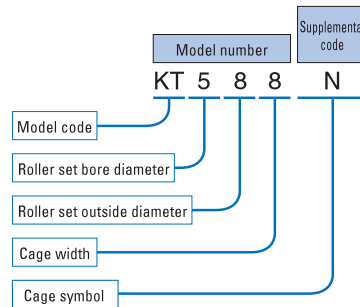

(c) Example of "Bore diameter or roller set bore diameter + width"

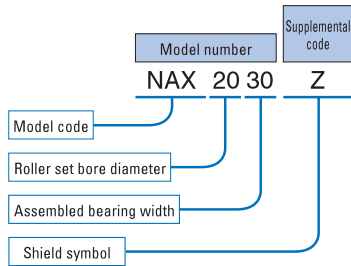

(d) Example of "Basic diameter"

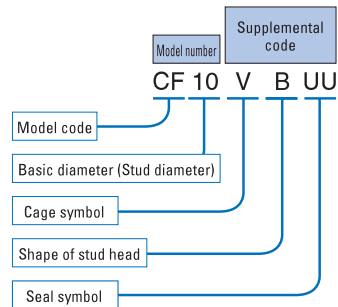

Accuracy

The accuracy of Needle Roller Bearings conforms to JIS B 1514:2000 (Tolerances of Rolling Bearings), and the dimensional accuracy and rotational accuracy are specified. The specified items are shown in Fig. 11.

Needle Roller Bearings are classified into 4 classes of accuracy. These classes are represented by the numbers 0, 6, 5 and 4, written in order of increasing accuracy.

Table 12 shows the accuracy for the inner rings of radial bearings, Table 13 shows the accuracy for the outer rings of radial bearings, Table 14 shows the tolerances for the smallest single roller set bore diameter of radial bearings, and Table 15 shows the permissible limit values of chamfer dimensions of radial bearings. For thrust bearings, see the section on accuracy of Thrust Bearings. Note that the series of Shell Type Needle Roller Bearings, Roller Bearings, Cam Followers, Roller Followers, Combined Type Needle Roller Bearings, and Crossed Roller Bearings have special accuracy. For further details, see the section on accuracy of each bearing series.

Remarks

The meanings of the new symbols for quantities used for accuracy of radial bearings are as follows:

- ① Δ represents the deviation of a dimension from the specified value.
- ② V represents the variation of a dimension.
- ③ Suffixes s , m , and p represent a single (or actual) measurement, a mean measurement, and a measurement in a single radial plane, respectively.

[Example] V_{dp} means the difference between the largest and the smallest of the bore diameters in a single radial plane (circularity). V_{dmp} means the difference between the largest and the smallest of the single plane mean bore diameters (cylindricity).

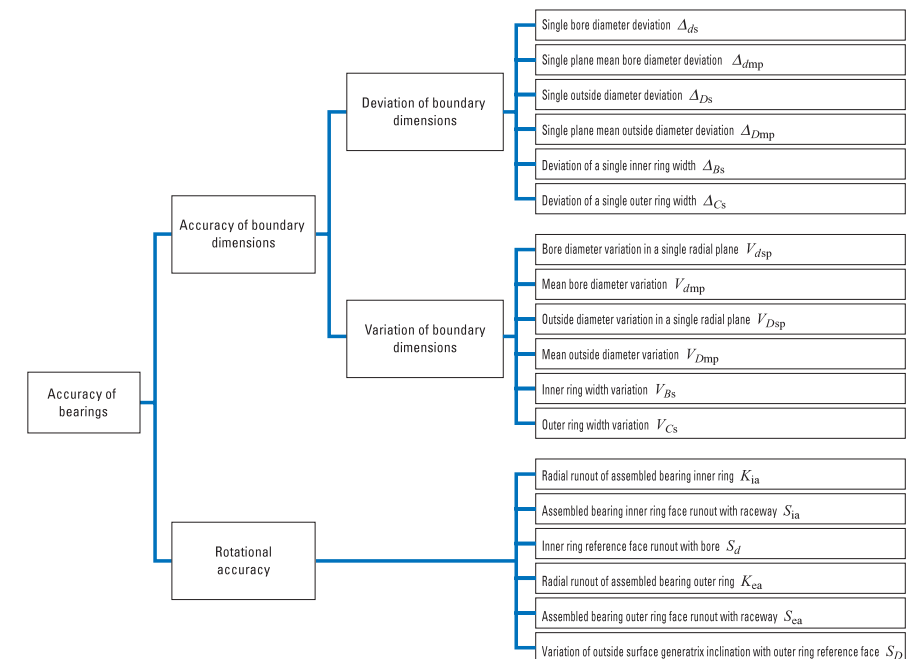

Fig. 11 Accuracy of bearings

Table 14 Tolerances for smallest single roller set bore diameter $F_{ws\ min}^{(1)}$ unit: μm

F_w Nominal roller set bore diameter mm		$\Delta F_{ws\ min}$ Deviation of smallest single roller set bore diameter	
Over	Incl.	High	Low
3	6	+ 18	+ 10
6	10	+ 22	+ 13
10	18	+ 27	+ 16
18	30	+ 33	+ 20
30	50	+ 41	+ 25
50	80	+ 49	+ 30
80	120	+ 58	+ 36
120	180	+ 68	+ 43
180	250	+ 79	+ 50
250	315	+ 88	+ 56
315	400	+ 98	+ 62
400	500	+ 108	+ 68

Note⁽¹⁾ This is the diameter of the cylinder used instead of the inner ring, where the radial clearance becomes 0 at least in one radial direction.

Table 15 Permissible limit values for chamfer dimensions of radial bearings unit: mm

$r_{s\ min}$ Smallest permissible single chamfer dimension	d Nominal bore diameter		$r_{s\ max}$ Largest permissible single chamfer dimension	
	Over	Incl.	Radial direction	Axial direction
0.1	—	—	0.55 ⁽²⁾	0.55 ⁽²⁾
0.15	—	—	0.6 ⁽²⁾	0.6
0.2	—	—	0.7 ⁽²⁾	0.8
0.3	—	40	0.8 ⁽²⁾	1
0.4 ⁽¹⁾	—	—	0.8	1.2
0.6	—	40	1.1 ⁽²⁾	2
1	—	50	1.5	3
1.1	—	120	1.9	3
1.5	—	120	2.3	4
2	—	80	3	4.5
2.1	—	280	3.5	5
2.5 ⁽¹⁾	—	100	3.8	6
3	—	280	4.5	7
4	—	—	5	8
5	—	—	5.5	8
6	—	—	6.5	9
6	—	—	8	10
6	—	—	10	13

Note⁽¹⁾ Not specified in JIS.

⁽²⁾ The numeric value differs from JIS.

Remark Although the exact shape of the chamfer is not specified, its profile in the axial plane must not extend beyond the imaginary circular arc of radius $r_{s\ min}$ which is tangential to the inner ring side surface and bearing bore surface or to the outer ring side surface and bearing outside surface. (See Fig. 12.)

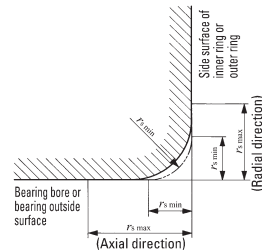

Fig. 12 Permissible values for chamfer dimensions

Methods of Measurement

Measurement of Needle Roller Bearings is based on JIS B 1515:1988 (Methods of Measurement for Roller Bearings). Tables 16 and 17 show some examples of the methods.

Special methods are used to measure Shell Type Needle Roller Bearings. Therefore, refer to the section on accuracy for these bearings on page B3.

Table 16 Measurement methods of accuracy of boundary dimensions

Measurement methods		Accuracy and definitions	
Bore diameter	<p>In principle, measurements of dimensions are carried out using a two-point measuring instrument for various radial planes.</p> <p>This does not apply to the regions within a range of 1.2 times the largest permissible single chamfer dimension from both side-surfaces of the inner ring.</p>	d_{mp} Single plane mean bore diameter	$d_{mp} = \frac{d_{sp\ max} + d_{sp\ min}}{2}$ $d_{sp\ max}$: Maximum value of bore diameter (d_s) obtained for a single radial plane $d_{sp\ min}$: Minimum value of bore diameter (d_s) obtained for a single radial plane
		Δd_{mp} Single plane mean bore diameter deviation	$\Delta d_{mp} = d_{mp} - d$ d : Nominal bore diameter
		V_{dsp} Bore diameter variation in a single radial plane	$V_{dsp} = d_{sp\ max} - d_{sp\ min}$
		V_{dmp} Mean bore diameter variation	$V_{dmp} = d_{mp\ max} - d_{mp\ min}$ $d_{mp\ max}$: Maximum value of single plane mean bore diameters d_{mp} for various radial planes $d_{mp\ min}$: Minimum value of single plane mean bore diameters d_{mp} for various radial planes
		Δd_s Single bore diameter deviation	$\Delta d_s = d_s - d$ d_s : Any measured bore diameter obtained in any radial plane
		Outside diameter	<p>In principle, measurements of dimensions are carried out using a two-point measuring instrument for various radial planes.</p> <p>This does not apply to the regions within a range of 1.2 times the largest permissible single chamfer dimension from both side-surfaces of the outer ring.</p>
ΔD_{mp} Single plane mean outside diameter deviation	$\Delta D_{mp} = D_{mp} - D$ D : Nominal outside diameter		
V_{Dsp} Outside diameter variation in a single radial plane	$V_{Dsp} = D_{sp\ max} - D_{sp\ min}$		
V_{Dmp} Mean outside diameter variation	$V_{Dmp} = D_{mp\ max} - D_{mp\ min}$ $D_{mp\ max}$: Maximum value of single plane mean outside diameters D_{mp} for various radial planes $D_{mp\ min}$: Minimum value of single plane mean outside diameters D_{mp} for various radial planes		
ΔD_s Single outside diameter deviation	$\Delta D_s = D_s - D$ D_s : Any measured outside diameter obtained in any radial plane		

Measurement methods		Accuracy and definitions	
Roller set bore diameter	In principle, this is measured using a master gauge. The master gauge is fixed on the base with its side surface downward, and the outer ring with needle rollers is fitted onto the gauge. An indicator probe is applied radially to the approximate middle of the outside surface of the outer ring, and a measuring load is applied in that direction inward and outward alternately to obtain the amount of outer ring movement. Measurements are taken at various angular positions by turning the outer ring.	Δ_{Fws} Deviation of a single roller set bore diameter	$\Delta_{Fws} = (d_G + \delta_{1m}) - F_w$ d_G : Outside diameter of master gauge δ_{1m} : Arithmetical mean value of outer ring movement F_w : Nominal dimension of roller set bore diameter
		$\Delta_{Fws\ min}$ Deviation of smallest single roller set bore diameter	$\Delta_{Fws\ min} = (d_G + \delta_{1min}) - F_w$ δ_{1min} : Minimum value of outer ring movement
Inner ring width	The inner ring width is measured between the base and the indicator probe perpendicular to the base. 	Δ_{Bs} Deviation of a single inner ring width	$\Delta_{Bs} = B_s - B$ B_s : Single inner ring width B : Nominal inner ring width
		V_{Bs} Inner ring width variation	$V_{Bs} = B_{s\ max} - B_{s\ min}$ $B_{s\ max}$: Maximum value of single inner ring width $B_{s\ min}$: Minimum value of single inner ring width
Outer ring width	The outer ring width is measured between the base and the indicator probe perpendicular to the base. 	Δ_{Cs} Deviation of a single outer ring width	$\Delta_{Cs} = C_s - C$ C_s : Single outer ring width C : Nominal outer ring width
		V_{Cs} Outer ring width variation	$V_{Cs} = C_{s\ max} - C_{s\ min}$ $C_{s\ max}$: Maximum value of single outer ring width $C_{s\ min}$: Minimum value of single outer ring width
Bearing height	In principle, the height is measured between the base plane on which the back surface of the outer ring is placed and the disk master placed on the back surface of the inner ring. 	Δ_{Ts} Deviation of the actual bearing height	$\Delta_{Ts} = T_s - T$ T_s : Actual bearing height T : Nominal bearing height

Table 17 Measurement methods for rotational accuracy

Accuracy	Measurement methods	
S_d Inner ring reference face runout with bore	The inner ring reference face runout with bore, in principle, is measured using a tapered arbor. The bearing is correctly fitted to the arbor, which is held by both centers so that it can rotate smoothly without play. An indicator probe is applied axially to the approximate middle of the width of the flat part of the inner ring reference side-surface. The tapered arbor together with the bearing is turned fully once to obtain the runout, which is the difference between the maximum and minimum readings of the indicator.	
S_D Variation of outside surface generatrix inclination with outer ring reference face	The outer ring reference side-surface is placed on a flat base, and the inner ring is left free. Two stoppers are applied to the outside cylindrical surface of the outer ring at a distance of 1.2 times the maximum permissible chamfer dimension ($r_{s\ max}$) from the base. Just above one of the stoppers, an indicator probe is applied radially to the outside cylindrical surface of the outer ring at a distance of 1.2 times the maximum permissible chamfer dimension ($r_{s\ max}$) from the upper side-surface. The outer ring is turned fully once along the stoppers to obtain the Variation which is the difference between the maximum and the minimum readings of the indicator.	
K_{ia} Radial runout of assembled bearing inner ring	The radial runout of the inner ring is measured by holding the tapered arbor, to which the bearing is correctly fitted, horizontally by both centers so that it can rotate smoothly without play. An indicator probe is applied radially downward to the approximate middle of the width of the outside-surface of the outer ring. The inner ring, together with the tapered arbor, is turned fully once to obtain the radial runout, which is the difference between the maximum and the minimum readings of the indicator. (The outer ring is not rotated.)	
K_{ea} Radial runout of assembled bearing outer ring	The radial runout of the outer ring is measured by holding the tapered arbor, to which the bearing is correctly fitted, horizontally by both centers so that it can rotate smoothly without play. An indicator probe is applied radially downward to the approximate middle of the width of the outside-surface of the outer ring. The outer ring is turned fully once to obtain the radial runout, which is the difference between the maximum and the minimum readings of the indicator. (The inner ring is not rotated.) In the case of needle roller bearings without inner ring, the measurement is carried out by using a cylindrical arbor instead of the inner ring.	
S_{ia} Assembled bearing inner ring face runout with raceway	The axial runout of the inner ring is measured by placing the outer ring on a flat base with the center axis of the bearing vertical. An indicator probe is applied axially to the approximate middle of the flat part of the inner ring reference side-surface. The specified measuring weight is applied to the inner ring reference side-surface in the direction of the center axis. The inner ring is turned fully once to obtain the runout, which is the difference between the maximum and the minimum readings of the indicator.	
S_{ea} Assembled bearing outer ring face runout with raceway	The axial runout of the outer ring is measured by placing the inner ring on the flat base with the center axis of the bearing vertical. An indicator probe is applied axially to the approximate middle of the flat part of the outer ring reference side-surface. The specified measuring weight is applied to the outer ring reference side-surface in the direction of the center axis. The outer ring is turned fully once to obtain the runout, which is the difference between the maximum and the minimum readings of the indicator.	

Clearance

The clearances between the bearing rings and rolling elements are known as bearing clearances. When either the inner or outer ring is fixed and a specified measuring load is applied to the free bearing ring inward and outward alternately in the radial direction, the displacement of the free bearing is referred to as the radial internal clearance. The amount of measuring load in this case is extremely small, and its values are specified in JIS B 1515:1988 (Methods of Measurement for Rolling Bearings).

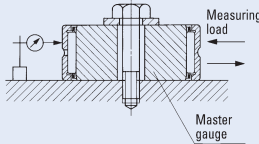
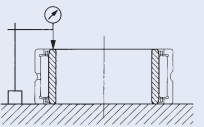
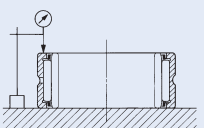
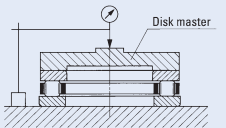
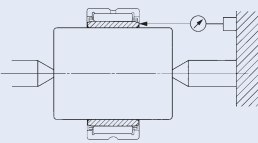
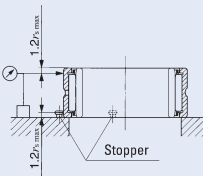
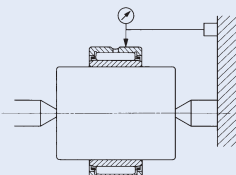
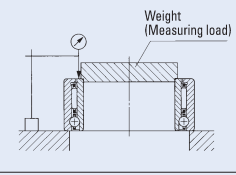
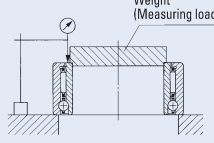
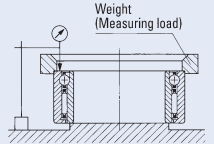
① Table 18 shows the radial internal clearances of Needle Roller Bearings with Inner Ring based on JIS B 1520:1995 (Radial internal clearances of rolling bearings). The radial internal clearances are classified into C2, CN, C3, C4, and C5, with clearances increasing in this order. CN is used under normal operating conditions. When a smaller range in radial internal clearance than the values shown in Table 18 is required,.

② In the case of Shell Type Needle Roller Bearings, the correct dimensional accuracy is achieved only after the bearings are press-fitted into the specified housing bore. Therefore, the clearances shown in Table 18 are not applicable. See page B5.

③ For the radial internal clearances of Cam Followers, Roller Followers and Crossed Roller Bearings, see the relevant section for each bearing.

Table 18 Radial internal clearances of Needle Roller Bearings

unit: μm

Nominal bore diameter mm		Classification of clearances									
<i>d</i>		C2		CN		C3		C4		C5	
Over	Incl.	Min.	Max.	Min.	Max.	Min.	Max.	Min.	Max.	Min.	Max.
—	10	0	25	20	45	35	60	50	75	—	—
10	24	0	25	20	45	35	60	50	75	65	90
24	30	0	25	20	45	35	60	50	75	70	95
30	40	5	30	25	50	45	70	60	85	80	105
40	50	5	35	30	60	50	80	70	100	95	125
50	65	10	40	40	70	60	90	80	110	110	140
65	80	10	45	40	75	65	100	90	125	130	165
80	100	15	50	50	85	75	110	105	140	155	190
100	120	15	55	50	90	85	125	125	165	180	220
120	140	15	60	60	105	100	145	145	190	200	245
140	160	20	70	70	120	115	165	165	215	225	275
160	180	25	75	75	125	120	170	170	220	250	300
180	200	35	90	90	145	140	195	195	250	275	330
200	225	45	105	105	165	160	220	220	280	305	365
225	250	45	110	110	175	170	235	235	300	330	395
250	280	55	125	125	195	190	260	260	330	370	440
280	315	55	130	130	205	200	275	275	350	410	485
315	355	65	145	145	225	225	305	305	385	455	535
355	400	100	190	190	280	280	370	370	460	510	600
400	450	110	210	210	310	310	410	410	510	565	665
450	500	110	220	220	330	330	440	440	550	625	735

Remark For bearings with CN clearance, no symbol is attached to the identification number. In the case of bearings with C2, C3, C4 and C5 clearances, these symbols are attached to the identification number.

Example NA 4905 C2

Selection of clearance

Radial clearances of needle roller bearings change according to bearing fit, temperature difference between bearing rings and rolling elements, loads, etc., and these factors greatly influence bearing life, accuracy, noise, generation of heat, etc. If radial clearances are too large, noise and vibration will increase, and if they are too small, abnormally great forces are exerted on the contact areas between raceways and rolling elements, resulting in abnormally high heat generation and a decrease in bearing life. Therefore, in the ideal case, the clearance provided before mounting should be such that it will become zero or slightly larger when the bearing has reached steady-state operation and the temperature has become constant (saturation temperature). However, it is difficult to achieve this ideal state for all bearings. Under general operating conditions, bearings with CN clearance are most widely used, and are manufactured to provide satisfactory performance when fitted according to Tables 21 and 22.

When radial internal clearances other than CN are used, refer to Table 19.

Table 19 Examples of selecting radial internal clearances other than CN clearance

Operating conditions	Selection of clearance
When heavy loads and shock loads are applied, and amount of interference is great.	C3 or larger clearance
When directionally indeterminate loads are applied, and a tight fit is required for both inner and outer rings.	
When temperature of inner ring is much higher than that of outer ring.	
When shaft deflection and/or mounting error to the housing are great.	
When less noise and vibration are required. When a loose fit is required for both inner and outer rings. When preload is required.	C2 or smaller clearance

Reduction of radial clearances by fit

When the inner or outer rings are interference fitted onto shafts and into housings, respectively, they expand or shrink due to elastic deformation. As the result, the radial clearances are reduced. These reduced radial clearances are called residual (internal) clearances.

The amount of reduction is obtained by the following equation, and it is generally 70 to 90% of the interference amount.

$$\Delta_C = \Delta_F + \Delta_E \quad \dots\dots\dots(24)$$

where, Δ_C : Amount of reduction of the radial clearance, mm

Δ_F : Amount of expansion of the outside diameter of inner ring, mm

Δ_E : Amount of shrinkage of the bore diameter of outer ring, mm

① Amount of expansion of the outside diameter of inner ring

· With solid shaft

$$\Delta_F = \Delta_{de} \frac{d}{F} \quad \dots\dots\dots(25)$$

· With hollow shaft

$$\Delta_F = \Delta_{de} \frac{d}{F} \frac{1 - (d_i/d)^2}{1 - (d/F)^2 (d_i/d)^2} \quad \dots\dots\dots(26)$$

where, Δ_{de} : Effective interference of inner ring, mm

d : Bore diameter of inner ring, mm

F : Outside diameter of inner ring, mm

d_i : Bore diameter of hollow shaft, mm

② Amount of shrinkage of the bore diameter of outer ring

· With steel housing ($D_0 = \infty$)

$$\Delta_E = \Delta_{De} \frac{E}{D} \quad \dots\dots\dots(27)$$

· With steel housing ($D_0 \neq \infty$)

$$\Delta_E = \Delta_{De} \frac{E}{D} \frac{1 - (D/D_0)^2}{1 - (E/D)^2 (D/D_0)^2} \quad \dots\dots\dots(28)$$

where, Δ_{De} : Effective interference of outer ring, mm

D : Outside diameter of outer ring, mm

E : Bore diameter of outer ring, mm

D_0 : Outside diameter of housing, mm

Reduction of radial clearances due to temperature differences between inner and outer rings

Frictional heat generated by rotation is dissipated through the shafts and housings as well as through oil and air. Under general operating conditions, heat dissipation is larger on the housing side compared with that on the shaft side, and the temperature of the outer ring is usually lower than that of the inner ring. During operation, the temperature of the rolling elements is the highest, followed by that of the inner ring and that of the outer ring. The amount of thermal expansion, therefore, varies, and the radial clearances are reduced. This reduced radial clearance is called the effective (internal) clearance, and the amount of reduction is obtained by the following equation:

$$\Delta \delta = \alpha \Delta_T E \dots\dots\dots(29)$$

where, $\Delta \delta$: Reduction of radial clearance, mm
 α : Coefficient of linear expansion for bearing steel
 $\approx 12.5 \times 10^{-6} \text{ 1/}^\circ\text{C}$
 Δ_T : Temperature difference between the outer ring and the inner ring plus rolling elements considered as one unit, $^\circ\text{C}$
 E : Bore diameter of outer ring, mm





The temperature difference Δ_T is considered to be 5 ~ 10 $^\circ\text{C}$ under normal operating conditions and 15 ~ 20 $^\circ\text{C}$ at high rotational speeds. Therefore, when the temperature difference is great, a correspondingly larger radial internal clearance must be selected.

Fit

Purpose of fit

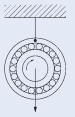
To achieve the best performance of needle roller bearings, it is important that the bearing rings are correctly fitted onto the shaft and into the housing. The purpose of fit is to provide the appropriate amount of interference required between the inner ring and the shaft or between the outer ring and the housing, to prevent harmful mutual slippage. If the interference is insufficient, it will cause a harmful relative displacement, known as creep, between the fitted surfaces in the circumferential direction. This may lead to abnormal wear of fitted surfaces, intrusion of wear particles into the bearing, generation of abnormal heat, vibration, etc. Therefore, a suitable fit must be selected.

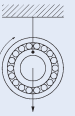
Table 20 Nature of radial load and fit

Nature of the load		Fit		
		Rotating conditions	Inner ring	Outer ring
Rotating load on inner ring Stationary load on outer ring		Inner ring : Rotating Outer ring : Stationary Load direction : Fixed	Interference fit	Clearance fit
		Inner ring : Stationary Outer ring : Rotating Load direction : Rotating with outer ring		
Rotating load on outer ring Stationary load on inner ring		Inner ring : Stationary Outer ring : Rotating Load direction : Fixed	Clearance fit	Interference fit
		Inner ring : Rotating Outer ring : Stationary Load direction : Rotating with inner ring		
Directionally indeterminate load	The load direction is not fixed, including cases where the load direction is fluctuating or there is an unbalanced load.	Inner ring : Rotating or stationary Outer ring : Rotating or stationary Load direction : Not fixed	Interference fit	Interference fit

Conditions for determination of fit

When determining a suitable fit for a bearing, it is necessary to consider various conditions such as nature and magnitude of the load, temperature, required rotational accuracy, material/finish grade/thickness of the shaft and housing, ease of mounting and dismounting, etc.

① Nature of load and fit

Basically, the appropriate fit depends on whether the load direction is rotational or stationary in relation to the inner and outer rings.

The relationship between the nature of radial loads and the fit is, in general, based on Table 20.

② Load amount and interference

The greater the load, the larger the interference must be.

When selecting an interference between the inner ring and the shaft, it is necessary to estimate the reduction of interference due to the radial load. The amount of reduction of interference is obtained by the following equations.

· When $F_r \leq 0.2C_0$

$$\Delta_{dF} = 0.08 \sqrt{\frac{d}{B}} F_r \times 10^{-3} \dots\dots\dots(30)$$

· When $F_r > 0.2C_0$

$$\Delta_{dF} = 0.02 \frac{F_r}{B} \times 10^3 \dots\dots\dots(31)$$

where, F_r : Radial load applied to bearing, N
 C_0 : Basic static load rating, N
 Δ_{dF} : Amount of reduction of inner ring interference, mm
 d : Bore diameter of inner ring, mm
 B : Width of inner ring, mm

③ Temperature conditions and change of interference

The interference of fitted surfaces is also influenced by the temperature difference between the bearing and the shaft and housing. For example, when steam is flowing through a hollow shaft, or when the housing is made of light metal, it is necessary to take into consideration the differences in temperature, the coefficient of linear expansion and other such factors.

Usually, the interference of the inner ring decreases as the bearing temperature increases during operation. If the temperature difference between the inside of the bearing and the outside of the housing is taken

as Δ_T , the temperature difference between the inner ring and the shaft can be estimated to be (0.1 ~ 0.15) Δ_T . Accordingly, the amount of reduction of the inner ring interference is obtained by the following equation.

$$\Delta_{dT} = (0.1 \sim 0.15) \Delta_T \alpha d \approx 0.0015 \Delta_T d \times 10^{-3} \dots\dots(32)$$

where, Δ_{dT} : Reduction amount of inner ring interference due to temperature difference, mm

Δ_T : Temperature difference between the inside of the bearing and the outside of the housing, $^\circ\text{C}$

α : Coefficient of linear expansion for bearing steel
 $\approx 12.5 \times 10^{-6} \text{ 1/}^\circ\text{C}$

d : Bore diameter of inner ring, mm

④ Shaft finish grade and interference

Since peaks of surface roughness of the fitted surface are crushed down when fitting the bearing, the effective interference becomes smaller than the apparent interference obtained by measurements, and it is generally obtained by the following equations.

· For ground shaft

$$\Delta_{de} = \frac{d}{d+2} \Delta_{df} \dots\dots\dots(33)$$

· For machined shaft

$$\Delta_{de} = \frac{d}{d+3} \Delta_{df} \dots\dots\dots(34)$$

where, Δ_{de} : Effective interference of inner ring, mm

d : Bore diameter of inner ring, mm

Δ_{df} : Apparent interference, mm

⑤ Minimum interference and maximum interference

When the load direction is rotating in relation to the inner ring, the inner ring is fitted with interference to the shaft.

For solid ground steel shafts, the minimum interference (required apparent interference) Δ_{df} is expressed by the following equation which is deduced from equations (30) or (31), (32) and (33).

$$\Delta_{df} \geq \frac{d+2}{d} (\Delta_{dF} + 0.0015 \Delta_T d \times 10^{-3}) \dots\dots(35)$$

It is desired that the maximum interference should be less than 1/1000 of the shaft diameter. In the case of the outer ring, the effective interference varies according to the housing material, thickness, shape, etc., so it is determined empirically.



Selection of fit

When selecting a suitable fit, in addition to the various conditions mentioned above, it is necessary to draw on experience and practical results.

Tables 21 and 22 show the most general fit data.

When a thin housing or a hollow shaft is used, the interference is made larger than an ordinary fit.

The fit between needle roller bearings without inner ring and shafts is based on Table 23.

For the fit between Shell Type Needle Roller Bearings and housing bores, see page B5.

For the fit between inner rings for Shell Type Needle Roller Bearings and shafts, see Table 22.

Table 21 Fit between needle roller bearings and housing bores (Not applicable to Shell Type Needle Roller Bearings)

Operating conditions		Tolerance class of housing bore ⁽¹⁾	Application examples (Reference)
Rotating load on outer ring	Heavy load on thin housing, large shock load	P7 ⁽²⁾	Flywheels
	Heavy load, normal load	N7 ⁽²⁾	Wheel bosses, transmission gears
	Light load, fluctuating load	M7	Pulleys, tension pulleys
Directionally indeterminate load	Large shock load	M7	Eccentric wheels, pumps
	Heavy load, normal load	K7	Compressors
	Normal load, light load	J7	Crankshafts, compressors
Stationary load on outer ring	Shock load, heavy load	J7	General bearing applications, gear shafts
	Normal load, light load	H7	General bearing applications
	With heat conduction through shaft	G7	Paper dryers
Light load, normal load, requirements of high-precision rotation and high rigidity		K6	Main spindles of machine tools

Notes⁽¹⁾ This table applies to steel or cast iron housings. For lighter metal, a tighter fit should be selected. For split housings, do not use a fit tighter than J7.

⁽²⁾ Care should be taken so that the radial internal clearance is not too small.

Remark Light load, normal load and heavy load represent $P \leq 0.06C$, $0.06C < P \leq 0.12C$, and $0.12C < P$, respectively, where P is the dynamic equivalent radial load and C is the basic dynamic load rating of the bearing to be used.

Table 22 Fit between needle roller bearings with inner ring and shafts

Operating conditions		Shaft dia. mm		Tolerance class of shaft ⁽¹⁾	Application examples (Reference)
		Over	Incl.		
Stationary load on inner ring	Light load, normal load, low or medium rotating speed	All shaft diameters		g6	Wheels on dead axles
	Heavy load, medium rotating speed			h6	Control lever gears Rope sheaves
	Especially smooth operation and accuracy are required.			h5	Tension pulleys
Rotating load on inner ring or Directionally indeterminate load	Light load	—	50	j5	Electric appliances, Precision machinery Machine tools, Pumps Blowers, Transportation vehicles
		50	100	k5	
		100	200	m6 ⁽²⁾ n6 ⁽³⁾	
	Normal load	—	50	k5 ⁽⁴⁾	General bearing applications Pumps, Transmission gearboxes, Wood working machinery, Internal combustion engines
		50	150	m5, m6 ⁽²⁾ n6 ⁽³⁾	
		150	200	p6 ⁽³⁾	
Heavy load Shock load	—	150	n6 ⁽³⁾	Industrial vehicles, Construction machinery Crushers	
	150	—	p6 ⁽³⁾		

Notes⁽¹⁾ This table applies to solid steel shafts.

⁽²⁾ It is necessary to examine the reduction of radial internal clearances caused by the expansion of inner rings after mounting.

⁽³⁾ It is necessary to use bearings with radial internal clearances greater than CN clearance.

⁽⁴⁾ For NATA and NATB, do not use a tighter fit than k5.

Table 23 Tolerance class of shafts assembled with needle roller bearings without inner ring

F_w Nominal roller set bore diameter mm		Radial internal clearance		
		Smaller than CN clearance	CN clearance	Larger than CN clearance
Over	Incl.	Tolerance class of shaft ⁽¹⁾		
—	65	k5	h5	g6
65	80	k5	h5	f6
80	160	k5	g5	f6
160	180	k5	g5	e6
180	200	j5	g5	e6
200	250	j5	f6	e6
250	315	h5	f6	e6
315	—	g5	f6	d6

Note⁽¹⁾ When the housing bore fit is tighter than K7, the shaft diameter is made smaller by considering shrinkage of roller set bore diameter after mounting.

Table 24 Fit values for radial bearings (JIS Class 0) (Fit with housing bore)

unit: μm

D Nominal outside diameter mm	Δd_{mp} Single plane mean outside diameter deviation	Δd_{mp}		G7	H7	J7	K6	K7	M7	N7	P7
		High	Low	Housing	Housing	Housing	Housing	Housing	Housing	Housing	Housing
3	6	0	-8	-24~-4	-20~0	-14~6	-10~6	-11~9	-8~12	-4~16	0~20
6	10	0	-8	-28~-5	-23~0	-16~7	-10~7	-13~10	-8~15	-4~19	1~24
10	18	0	-8	-32~-6	-26~0	-18~8	-10~9	-14~12	-8~18	-3~23	3~29
18	30	0	-9	-37~-7	-30~0	-21~9	-11~11	-15~15	-9~21	-2~28	5~35
30	50	0	-11	-45~-9	-36~0	-25~11	-14~13	-18~18	-11~25	-3~33	6~42
50	80	0	-13	-53~-10	-43~0	-31~12	-17~15	-22~21	-13~30	-4~39	8~51
80	120	0	-15	-62~-12	-50~0	-37~13	-19~18	-25~25	-15~35	-5~45	9~59
120	150	0	-18	-72~-14	-58~0	-44~14	-22~21	-30~28	-18~40	-6~52	10~68
150	180	0	-25	-79~-14	-65~0	-51~14	-29~21	-37~28	-25~40	-13~52	3~68
180	250	0	-30	-91~-15	-76~0	-60~16	-35~24	-43~33	-30~46	-16~60	3~79
250	315	0	-35	-104~-17	-87~0	-71~16	-40~27	-51~36	-35~52	-21~66	1~88
315	400	0	-40	-115~-18	-97~0	-79~18	-47~29	-57~40	-40~57	-24~73	1~98
400	500	0	-45	-128~-20	-108~0	-88~20	-53~32	-63~45	-45~63	-28~80	0~108

Remark The negative value denotes a clearance and the positive value denotes an interference.

Table 25 Fit values for radial bearings (JIS Class 0) (Fit with shaft)

unit: μm

d Nominal bore diameter mm	Δd_{mp} Single plane mean bore diameter deviation	Δd_{mp}		g6	h5	h6	j5	k5	m5	m6	n6	p6
		High	Low	Bearing	Bearing	Bearing	Bearing	Bearing	Bearing	Bearing	Bearing	Bearing
3	6	0	-8	-12~4	-5~8	-8~8	-2~11	1~14	4~17	4~20	8~24	12~28
6	10	0	-8	-14~3	-6~8	-9~8	-2~12	1~15	6~20	6~23	10~27	15~32
10	18	0	-8	-17~2	-8~8	-11~8	-3~13	1~17	7~23	7~26	12~31	18~37
18	30	0	-10	-20~3	-9~10	-13~10	-4~15	2~21	8~27	8~31	15~38	22~45
30	50	0	-12	-25~3	-11~12	-16~12	-5~18	2~25	9~32	9~37	17~45	26~54
50	80	0	-15	-29~5	-13~15	-19~15	-7~21	2~30	11~39	11~45	20~54	32~66
80	120	0	-20	-34~8	-15~20	-22~20	-9~26	3~38	13~48	13~55	23~65	37~79
120	140											
140	160	0	-25	-39~11	-18~25	-25~25	-11~32	3~46	15~58	15~65	27~77	43~93
160	180											
180	200											
200	225	0	-30	-44~15	-20~30	-29~30	-13~37	4~54	17~67	17~76	31~90	50~109
225	250											
250	280	0	-35	-49~18	-23~35	-32~35	-16~42	4~62	20~78	20~87	34~101	56~123
280	315	0	-40	-54~22	-25~40	-36~40	-18~47	4~69	21~86	21~97	37~113	62~138
315	355											
355	400	0	-45	-60~25	-27~45	-40~45	-20~52	5~77	23~95	23~108	40~125	68~153
400	450											
450	500	0	-45	-60~25	-27~45	-40~45	-20~52	5~77	23~95	23~108	40~125	68~153

Remark The negative value denotes a clearance and the positive value denotes an interference.

Design of Shaft and Housing

Accuracy and roughness of shaft and housing

Accuracy and roughness of fitting surface

Since the bearing rings of needle roller bearings are thin, their performance is easily affected by poor accuracy of shafts or housings. Under general operating conditions, the fitting surfaces of shafts and housings can be finished by lathe turning. However, when the load is great and high accuracy and low noise are required, a grinding finish is required.

Table 26 shows the accuracy and roughness of fitting surfaces for general use.

Accuracy and roughness of raceway surface

In case of needle roller bearings unlike other bearings, mating surfaces such as shaft and housing bore surfaces can be used directly as the raceway surfaces. For such use, accuracy and roughness of the raceway surfaces are important because they will influence bearing life, noise and accuracy.

In general, accuracy and roughness of raceway surfaces are based on Table 26.

Table 26 Specifications of shafts and housings for radial needle roller bearings

Item	Shaft		Housing bore	
	Fitting surface	Raceway surface	Fitting surface	Raceway surface
Circularity	0.3 × IT6 ⁽¹⁾	0.3 × IT6 ⁽¹⁾	0.3 × IT7 ⁽¹⁾	0.3 × IT7 ⁽¹⁾
	or 0.3 × IT5 ⁽¹⁾	or 0.3 × IT5 ⁽¹⁾	or 0.3 × IT6 ⁽¹⁾	or 0.3 × IT6 ⁽¹⁾
Cylindricity	0.5 × IT6 ⁽²⁾	0.3 × IT6 ⁽¹⁾	0.5 × IT7 ⁽²⁾	0.3 × IT7 ⁽¹⁾
	or 0.5 × IT5 ⁽²⁾	or 0.3 × IT5 ⁽¹⁾	or 0.5 × IT6 ⁽²⁾	or 0.3 × IT6 ⁽¹⁾
Surface roughness $\mu\text{m} R_a$ ($\mu\text{m} R_z$)	0.8 (3.2)	0.2 ⁽³⁾ (0.8)	1.6 (6.3)	0.2 ⁽³⁾ (0.8)
Hardness	—	58~64HRC ⁽⁴⁾	—	58~64HRC ⁽⁴⁾

Notes⁽¹⁾ 30% or less of the dimensional tolerance for shafts or housing bores is recommended.

⁽²⁾ 50% or less of the dimensional tolerance for shafts or housing bores is recommended.

⁽³⁾ When required accuracy is not critical, a surface roughness within 0.8 $\mu\text{m} R_a$ (3.2 $\mu\text{m} R_z$) is allowable.

⁽⁴⁾ An appropriate thickness of the hardened layer is required.

Inclination of shaft

Shafts and outer rings may have some inclination between them due to deflection of the shaft, machining accuracy of shafts and housings, errors in mounting, etc.

In this case, the use of two or more bearings in tandem arrangement on a single shaft should be avoided. Instead, a bearing with large load ratings should be used.

It is recommended that inclination of shafts be less than 1/1000.

Table 27 Tolerance class IT values for basic dimensions

Basic dimension mm		Tolerance class		
Over	Incl.	IT5	IT6	IT7
		Tolerance μm		
—	3	4	6	10
3	6	5	8	12
6	10	6	9	15
10	18	8	11	18
18	30	9	13	21
30	50	11	16	25
50	80	13	19	30
80	120	15	22	35
120	180	18	25	40
180	250	20	29	46
250	315	23	32	52
315	400	25	36	57
400	500	27	40	63
500	630	30	44	70

Raceway materials and heat treatment

When using shafts and housings as raceways, the following materials are generally used.

High-carbon chromium bearing steel		
	SUJ2	JIS G 4805
Carburizing steel	SCM415 ~ 421	JIS G 4105
Carburizing steel	SNCM 220	JIS G 4103
Carburizing steel	SCr 420	JIS G 4104
Carburizing steel	SNC 415、815	JIS G 4102
Carburizing steel	S 15 CK	JIS G 4051

In addition, S50C and S55C (JIS G 4051) can be used after through hardening or induction hardening. The hardened layer produced by tempering at +160 ~ +180 °C after hardening must have a fine uniform martensite microstructure.

When hardening the raceway surface by case hardening or induction hardening, a surface hardness of 58 ~ 64HRC and an appropriate thickness of the hardened layer must be ensured. The minimum effective thickness of the hardened layer after heat treatment and grinding is defined as the distance from the surface to the depth where the hardness is 513HV (50HRC), and it is obtained by the following equation.

$$E_{ht} \geq 0.8D_w(0.1 + 0.002D_w) \quad \dots\dots\dots(36)$$

where, E_{ht} : Minimum effective thickness of the hardened layer, mm

D_w : Roller diameter, mm

Generally, the required effective thickness of the hardened layer is at least 0.3 mm.

Dimensions related to mounting of bearings

The dimensions of shaft and housing related to mounting of the needle roller bearings are shown in the table of dimensions for each bearing. (See Fig. 13.)

The minimum value of the shaft shoulder diameter d_a which receives the inner ring, and the maximum value of the housing shoulder diameter D_a which receives the outer ring, represent the effective shoulder diameters (excluding the chamfered part) which make proper contact with the side faces of the inner and outer rings respectively.

Also, the maximum value of the shaft shoulder (or inner ring retaining piece) diameter d_a is the dimension related to the ease of mounting/dismounting of the shaft and inner ring to/from the housing and outer ring.

The largest permissible single corner radius $r_{as \max}$ of the shaft and housing must be smaller than the smallest permissible single chamfer dimension $r_{s \min}$ of the bearing so that the side surface of the bearing can make proper contact with the shoulder. Table 28 shows the related dimensions.

For dimensions of the fillet relief when finishing the shaft or housing by grinding, the values shown in Table 29 are recommended.

For other dimensions related to mounting, see the related section for each bearing as required.

In addition, for ease in dismounting of bearings, it is convenient to make notches in the shoulder of the shaft or housing to allow the insertion of dismounting hooks.

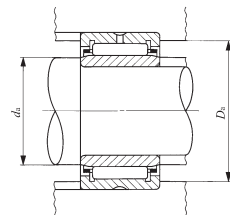

Fig. 13 Dimensions related to mounting

Table 28 Largest permissible single corner radius of shafts and housings $r_{as \max}$

$r_{s \min}$ Smallest permissible single chamfer dimension	$r_{as \max}$ Largest permissible single corner radius of shafts and housings	unit: mm
0.1 0.15 0.2	0.1 0.15 0.2	
0.3 0.4 0.6	0.3 0.4 0.6	
1 1.1 1.5	1 1 1.5	
2 2.1 2.5	2 2 2	
3 4 5	2.5 3 4	

Table 29 Fillet relief dimensions for ground shafts and housings

$r_{s \min}$ Smallest permissible single chamfer dimension	Fillet relief dimensions			unit: mm
	t	r_{gs}	b	
1	0.2	1.3	2	
1.1	0.3	1.5	2.4	
1.5	0.4	2	3.2	
2	0.5	2.5	4	
2.1	0.5	2.5	4	
3	0.5	3	4.7	
4	0.5	4	5.9	
5	0.6	5	7.4	
6	0.6	6	8.6	
7.5	0.6	7	10	

Sealing

To obtain the best performance of rolling bearings, it is necessary to prevent leakage of lubricant and the

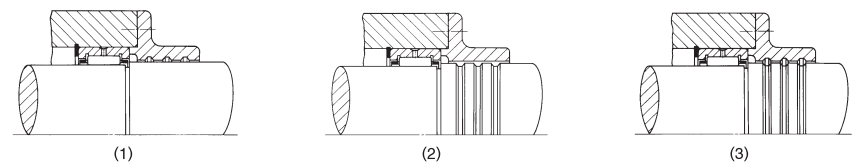

Fig. 14

entry of harmful foreign substances, such as dirt, dust and water. For this reason, sealing devices must always work effectively to seal and prevent against dust penetration under all operating conditions. Also, when selecting a suitable sealing method, it is necessary to consider such factors as the type of lubricant, peripheral speed of the seal, operating temperature, shaft eccentricity, seal friction, etc. as well as ease of assembly and disassembly.

Sealing methods are of the non-contact and contact types, and it is necessary to select the appropriate type depending on the application.

Non-contact type sealing method

There are many methods of non-contact type sealing, including the use of oil grooves, flingers and labyrinths, which utilize the centrifugal force and narrow gaps.

Since they do not make direct contact with the shaft or housing, it is unnecessary to consider friction and wear, and the non-contact sealing method is suitable for high speed rotation and high operating temperatures. However, because of gaps, this method is not always sufficient in preventing oil leakage and dust entry when the machine is not in operation.

Oil groove

Oil grooves are provided on either the shaft or housing bore, or on both for more effective sealing (See Fig. 14.). The clearance between the shaft and the housing bore should be as small as possible, and the values shown in Table 30 are generally used, taking into consideration errors in machining and assembly, shaft deformation, etc. Three or more grooves are made with a width of 3 ~ 5 mm and a depth of 4 ~ 5 mm. If the grooves are filled with grease, it will be more effective for dust prevention.

As shown in Fig. 15, helical grooves are suitable for horizontal shafts which have a fixed direction of rotation. Right or left handed grooves are used according to the direction of rotation, and they are used for oil lubrication normally in conjunction with a suitable anti-dust device.

Table 30 Clearance between grooved shaft and housing bore unit: mm

Shaft dia.	Clearance
Incl. 50 mm	0.25 ~ 0.4
Over 50 mm	0.5 ~ 1

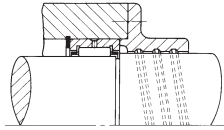
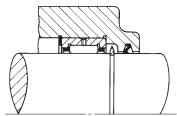

Fig. 15

② Flinger

The oil flinger is a disk attached to the shaft which throws off oil due to the centrifugal force of rotation and thus prevents oil leakage and the entry of foreign particles. Fig. 16 (1) shows an example in which the flinger is located inside the housing, mainly to prevent oil leakage. Since it sucks in dust and dirt, it should be used in a dust free environment. Fig. 16 (2) shows an example in which the flinger is located outside the housing, and is used in combination with another sealing device, to prevent entry of foreign particles.



(1)

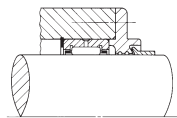

(2)

Fig. 16

③ Labyrinth

Although it is a little difficult to make, the labyrinth is very effective in preventing oil leakage especially at high speeds. At low speeds, filling the labyrinth with grease is effective in preventing the entry of dust. In Fig. 17, it is necessary to split the housing or cover plate into two. In Fig. 18, it is easy to assemble, and if combined with an oil seal, it improves the sealing effect.

Table 31 shows the labyrinth clearances generally used.

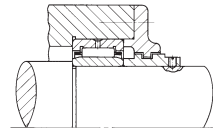

(1)

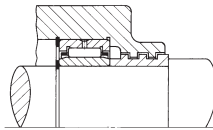

(2)

Fig. 17

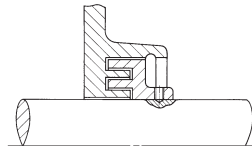

Fig. 18

Table 31 Labyrinth clearance unit: mm

Shaft dia.	Clearance	
	Radial direction	Axial direction
Incl. 50 mm	0.25 ~ 0.4	1 ~ 2
Over 50 mm	0.5 ~ 1	3 ~ 5

Contact type sealing method

In this type of sealing, the shaft is sealed by the application of pressure resulting from the elasticity of the seal material to the sealing surface of the shaft, which rotates, reciprocates or oscillates. Synthetic rubber, synthetic resin and felt are generally used as sealing materials.

① Oil seal

Synthetic rubber oil seals are the most general type of sealing used. The sealing effect is obtained when the elastic lip comes into contact with the shaft. Some lips are spring-loaded to maintain adequate pressing force.

The sliding surfaces of the lip and the shaft always show frictional behavior such that the boundary lubrication and fluid lubrication are mixed. If there is an insufficient amount of oil between the contact surfaces, it will cause heat generation, wear and seizure. Conversely, if the oil film is too thick, it may cause oil leakage.

General oil seals are specified in JIS B 2402.

Oil Seals for Needle Roller Bearings (See page 486.) have a low sectional height to match the Needle Roller Bearings.

Nitrile rubber is generally used as the material for oil seal lips. Table 32 shows the materials and their operating temperature ranges.

The finished surface of the shaft where the seal lip makes contact must have an appropriate surface roughness, as shown in Table 33, according to the peripheral speed. It must also have accurate circularity, and the shaft eccentricity should be less than 0.05 mm.

To increase wear resistance, the hardness of the sliding part of the shaft must be more than 40HRC. This can be achieved by hard-chrome plating or heat treatment.

Table 32 Seal materials and operating temperatures

Seal material		Operating temperature range °C
Synthetic rubber	Nitrile rubber	- 25 ~ + 120
	Acrylic rubber	- 15 ~ + 130
	Silicon rubber	- 50 ~ + 180
	Fluoro rubber	- 10 ~ + 180
Tetrafluoroethylene resin		- 50 ~ + 220

Table 33 Peripheral speed and surface roughness of shaft

Peripheral speed m/s		Surface roughness μmR_a (μmR_y)
Over	Incl.	
—	5	0.8(3.2)
5	10	0.4(1.6)
10	—	0.2(0.8)

② Felt seal

Because of their simple structure, felt seals have long been used to protect grease lubrication from dust. Since felt absorbs some grease during operation, it hardly causes heat generation and seizure, but it cannot be used when the peripheral speed of the shaft is high (more than 4 m/s). Where there is a high concentration of dirt and dust, they may become attached to the contact surface of felt, sometimes scratching the shaft surface. To prevent this, two felt seals are placed apart from each other, or a felt seal is used together with a synthetic rubber seal.

Lubrication

Purpose of lubrication

The main purpose of bearing lubrication is to reduce friction and wear and to prevent heat generation and seizure. The lubricant and the lubricating method have a big influence on the operating performance of the bearing, and it is therefore necessary to select them suitably for the operating conditions. The effects of lubrication are as follows.

1 Reduction of friction and wear

At the contact surfaces between the race rings, rolling elements and cage of the bearing, lubrication prevents metal-to-metal contact, and reduces friction and wear due to sliding and rolling, in the latter of which micro-slips occur by differential slip, skew, spin, or elastic deformation.

2 Elimination of frictional heat

The lubricant removes the heat generated by friction or transferred from outside, and prevents overheating of the bearing. Circulating lubrication is generally used for this purpose.

3 Influence on bearing life

The bearing life is extended if the rolling contact surfaces between the race rings and rolling elements are separated by an oil film of adequate thickness, and is shortened if the oil film is inadequate due to low oil viscosity, etc.

4 Rust prevention

The lubricant prevents rust formation on the inside and outside surfaces of the bearing.

5 Dust prevention

Grease lubrication is particularly effective for dust prevention. Oil circulating or jet lubrication is effective in washing foreign particles away from the area around the bearing.

Methods of lubrication

Grease lubrication and oil lubrication are generally used for rolling bearings. In special cases, solid lubricants are also used.

In general, grease lubrication requires the simplest sealing device. It is therefore economical, and widely used. Also, once filled with grease, the bearing can be used for a long period without replenishing the grease. However, compared with oil, its heat removal properties and cooling capacity are inferior, since grease has high flow resistance, which causes high churning heat.

Oil has greater fluidity and superior heat removal properties. It is therefore suitable for high-speed operations. In addition, it is simple to filter out dust and dirt from oil. Thus it can prevent the generation of noise and vibration and increase bearing life. Another advantage of oil lubrication is that it offers the possibility for selecting the appropriate method for particular operating conditions from among various available lubrication methods. However, measures to prevent oil leakage are required. As a guideline for selection, Table 34 compares grease and oil lubrication.

Table 34 Comparison between grease lubrication and oil lubrication

Item	Grease lubrication (1)	Oil lubrication
Sealing, Housing structure	Simple	Slightly complicated
Temperature	High temperature not allowed	High temperature allowed (Cooling effect by circulation)
Rotational speed	Low and medium speeds	High speed allowed
Load	Low and medium loads	High load allowed
Maintenance	Easy	Elaborate (Pay special attention to oil leaks.)
Lubricant replacement	Slightly complicated	Simple
Lubrication performance	Good	Very good
Dust filtration	Difficult	Simple
Entry of dust and dirt	Easy measures for protection	Dust and dirt can be removed by filtering in circulating lubrication.

Note(1) This represents bearing grease for general use.

Grease lubrication

1 Amount of grease to be filled

The amount of grease to be filled depends on the housing structure, dimensions, type of grease used and atmosphere. Generally, filling about 1/3 to 1/2 of the free space inside of the bearing and the housing is considered to be appropriate. Too much will cause a rise in temperature, and care should be taken especially at high speed rotations.

In Fig. 19, several grease pockets are provided by the grease sectors on one side of the bearing. Even if the filled grease is dispersed by the centrifugal force at high rotational speeds, it is trapped by the grease pockets and diverted back into the bearing again. Old grease accumulates in the space on the opposite side of the bearing, and this can be removed periodically by taking off the cover.

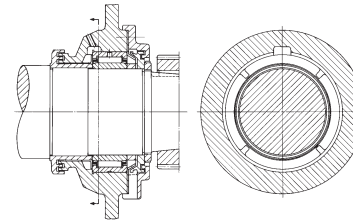

Fig. 19

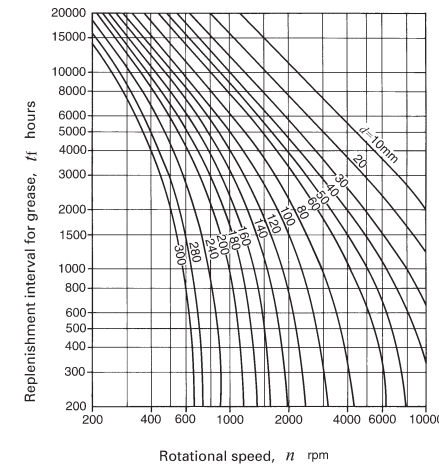

Fig. 20 Interval for replenishment of grease

Remark
d is the bore diameter of the inner ring. For a bearing without an inner ring, the roller set bore diameter F_w is used for d.

2 Replenishment of grease

The life of grease depends on its type and quality, the type and dimensions of the bearing, operating conditions, temperature, amount of wear, penetration of foreign particles and water, etc.

Fig. 20 shows the replenishment intervals for grease, and is used as a general guideline. The values obtained from this diagram apply to cases in which the load condition is normal, the machine body is stationary, and the operating temperature on the outer surface of bearing outer ring is less than +70 °C. If the temperature exceeds +70 °C, as a general rule, the replenishment interval is halved for every 15 °C increase.

Oil lubrication

① Oil bath lubrication

This is the most commonly used oil lubrication method, and is used for medium and low speeds. If the amount of oil is too large, heat will be generated by churning, and if the amount is too small, seizure will occur. Therefore, the correct amount of oil must be maintained. When the machine is stationary, the correct oil level in the case of a bearing mounted on a horizontal shaft, is near the center of the lowest rolling element. In the case of a vertical shaft, about 50% of the surfaces of the rolling elements should be submerged in oil.

It is desirable to provide an oil gauge so that the oil level can be easily checked while the machine is stationary or running.

② Oil drip lubrication

Oil drips, which are fed down from a sight-feed oiler or along a fiber string, become an oil spray due to wind pressure generated by the rotating cage, shaft, nut, etc., or they strike the rotating parts and form an oil spray, which fills up the housing and every required part. Because oil spray removes frictional heat, this method has a more effective cooling effect than the oil bath method, and is widely used for high-speed rotation and medium load conditions.

In the case of the sight-feed oiler (Fig. 21), the number of drips can be adjusted. However, this is difficult using the string-feed method. The number of drips depends on the bearing type, rotational speed, etc., but 5 ~ 6 drips per minute is generally used.

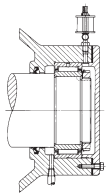

Fig. 21 Oil drip lubrication

③ Oil splash lubrication

In this method, oil is splashed in all directions by the rotation of the gear or disk. This can be used for considerably high-speed rotations without soaking the bearing directly in oil.

In the gear case where shafts and bearings are lubricated with the same oil, wear particles may be introduced into the bearing as they might get mixed with the oil. In this case, a permanent magnet is provided at the bottom of the gear case to collect metal particles, or a shield plate is installed next to the bearing. Fig. 22 shows another method in which the splashed

oil flows along the grooves in the case and accumulates in the oil pockets, keeping the oil level constant. So the oil is steadily supplied to the bearing.

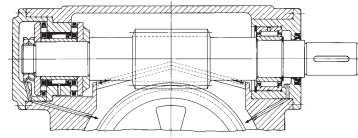

Fig. 22 Oil splash lubrication

④ Oil circulating lubrication

When automatic lubrication is more economical because lubrication is required at many points, or when cooling is required for high rotational speed, this method is used. The oil is supplied with a pump, which can control the oil pressure, and a filter or cooler, etc. can be set up in the circulation system, making this an ideal method of lubrication. As shown in Fig. 23, the oil supply and discharge ports are located opposite to each other, and the discharge port is made large to prevent the accumulation of oil.

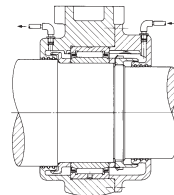

Fig. 23 Oil circulating lubrication

⑤ Oil mist lubrication

After dirt and dust are removed by a filter, the oil is turned into a spray by dry compressed air, and this lubricates the bearing. When the air and oil pass through the bearing, the air cools the bearing and the oil lubricates it. In addition, because the air inside the housing is at a higher pressure than the outside air, the entry of water and foreign particles is prevented. There are many other advantages of this method, and it is suitable for high rotational speed applications such as high speed internal grinding spindles.

⑥ Oil jet lubrication

This is a highly reliable lubrication method and is used under severe conditions such as ultra-high rotational speeds and high temperatures. The speed of the oil jet should be more than 20% of the peripheral speed of the inner ring raceway surface, since the air around

the bearing rotates together with the bearing forming an air wall. As shown in Fig. 24, the jet from the nozzle blows directly into the space between the inner ring and the cage. Due to the large amount of oil being used, it is more effective to make the discharge port larger, and use the forced discharge.

When the $d_m n$ value (mean value of the bearing outside and bore diameters in millimeter x rotational speed in revolutions per minute) is more than 1,000,000, the speed of the jet should be 10 ~ 20 m/s, the nozzle diameter should be about 1 mm, oil supply pressure should be 0.1 ~ 0.5 MPa, and the oil supply amount should be about 500 cc/min or greater. When the rotational speed is higher, the oil supply pressure and the oil amount should be higher.

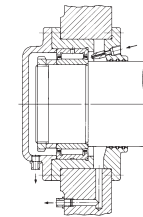

Fig. 24 Oil jet lubrication

Table 35 Properties of various types of grease

Name (Common name)	Calcium grease	Sodium grease	Aluminum grease	Mixed base grease	Barium grease	Lithium grease			Non-soap base grease (Non-soap grease)		
	(Cup grease)	(Fiber grease)	(Mobile grease)			(Diester grease)	(Silicon grease)	(Bentone grease)			
Base oil	Mineral oil	Mineral oil	Mineral oil	Mineral oil	Mineral oil	Mineral oil	Diester oil	Silicon oil	Mineral oil	Synthetic oil	
Thickener	Ca soap	Na soap	Al soap	Na + Ca soap, Li + Ca soap	Ba soap	Li soap	Li soap	Li soap	Bentone	Silica gel, Polyurea, etc.	
Appearance	Buttery	Fibrous and buttery	Stringy and buttery	Fibrous and buttery	Fibrous and buttery	Buttery	Buttery	Buttery	Buttery	Buttery	
Pour point °C	80 ~ 90	150 ~ 180	70 ~ 90	160 ~ 190	150 ~ 180	170 ~ 190	170 ~ 190	200 ~ 250	200 ~	None	
Operating temperature range °C	-10 ~ +70	-20 ~ +120	-10 ~ +80	-10 ~ +100	-10 ~ +135	-20 ~ +120	-50 ~ +120	-50 ~ +180	-10 ~ +150	~ +200	
Pressure resistance	Strong to weak	Strong to medium	Strong	Strong	Strong to medium	Medium	Medium	Weak	Medium to weak	Medium	
Water resistance	Good	Poor	Good	Good, poor for Na-Ca soap grease	Good	Good	Good	Good	Good	Good	
Mechanical stability	Fair	Good	Poor	Good	Poor	Excellent	Excellent	Excellent	Good	Good to poor	
Features and application	Contains about 1% water. When the temperature rises to more than +80 °C, the water evaporates and the grease separates into oil and soap. This is used for medium loads.	Long fibrous grease cannot withstand high speeds, but has good pressure resistance properties. Short fibrous grease is comparatively good for high speeds.	It has water and rust resistances, and adheres easily to metal surface.	Usable at fairly high speeds.	It has water and heat resistant properties. This is an all-purpose grease.	This is the best all-purpose grease among soap based greases.	Excellent under low temperature conditions and has superior frictional properties. Suitable for small bearings used in measuring instruments.	Mainly used for high temperatures. Not suited to high speeds and heavy loads.	Generally good heat resistance. Grease having a mineral base oil is for general use. Grease having a synthetic base oil is suitable for special use where superior heat and chemical resistance properties are required.		

1 Base oil

Petroleum lubricating oil is usually used as the base oil.

As the lubricating performance of grease depends mainly on that of base oil, the viscosity of the base oil is an important property. In general, low viscosity is suitable for light-load and high-speed rotations, and high viscosity for heavy-load and low-speed rotations. Synthetic lubricants of the diester or silicon series are used instead of lubricants of the petroleum series in consideration of the pour point and high temperature stability.

2 Thickener

As shown in Table 35, metal soap bases are mostly used as thickeners. In particular, Na-soap is water-soluble and emulsifies easily, and it cannot be used in damp or wet areas. The type of thickener and the pour point of grease have a close relationship. In general, the higher the pour point, the higher the maximum usable temperature of grease. However, even when the grease uses a thickener having a high pour point, its upper operating temperature limit is low if its base oil has low heat resistance.

3 Consistency

This represents the hardness grade of grease. Grease becomes harder in proportion to the amount of thickener if the same thickener is used. Immediately after grease has been stirred (usually 60 times), a depression is formed in the grease in a specified time using a specified cone. The consistency (combined consistency) is expressed by the value of depth of depression (mm) multiplied by 10. This value gives an estimate of the fluidity during operation with a greater value for softer grease. Table 36 shows the consistency number of grease and the relationship between the consistency and operating conditions.

Table 36 Consistency and operating conditions of grease

NLGI consistency number	Combined consistency	Application
0	385 ~ 355	For centralized lubrication,
1	340 ~ 310	For oscillating motion
2	295 ~ 265	For general use
3	250 ~ 220	For general use, For high temperature
4	205 ~ 175	For sealing with grease

4 Additives

Additives include various types of substances, which are added to grease in small quantities to improve its characteristics. For example, when a bearing is kept

running for long periods of time, its temperature rises. This results in oxidation of the lubricant and formation of oxides, which lead to corrosion of the bearing. Thus, when a bearing is to be operated for long periods of time without regreasing, antioxidants are added. In addition, grease containing extreme pressure additives is suitable for use in places that are subjected to heavy loads.

5 Miscibility of different greases

In principle, it is desirable to use grease of the same brand. However, when the mixing of different greases is unavoidable, greases with the same type of thickener and with a similar type of base oil should be used.

It should be noted that if different types of grease are mixed, they may interact with each other and the consistency will become softer than that for the individual greases.

Lubricating oil

For rolling bearings, refined mineral oil or synthetic oil is used. To improve its properties, antioxidant additives, extreme pressure additives and detergent additives are added as required.

When selecting lubricating oil, it is important to select oil which has adequate viscosity under operating temperatures. If the viscosity is too low, the formation of the oil film will be insufficient, causing abnormal wear and seizure. On the other hand, if the viscosity is too high, it will generate excessive heat or increase power loss due to viscous resistance. As a general standard, oil having higher viscosity should be used for heavier loads and oil having lower viscosity should be used for higher rotational speeds.

Under conditions of normal use for various bearings, the values of viscosity shown in Table 37 will be a guideline.

The relationship between viscosity and temperature can be obtained from Fig. 25. Also, Table 38 shows examples of selecting lubricating oil according to the conditions of bearing use.

Table 37 Bearing series and required viscosity of lubricating oil

Bearing series	Kinematic viscosity at operating temperatures
Needle roller bearings Roller bearings	13 mm ² /s or more
Crossed roller bearings	20 mm ² /s or more
Thrust needle roller bearings Thrust roller bearings	32 mm ² /s or more

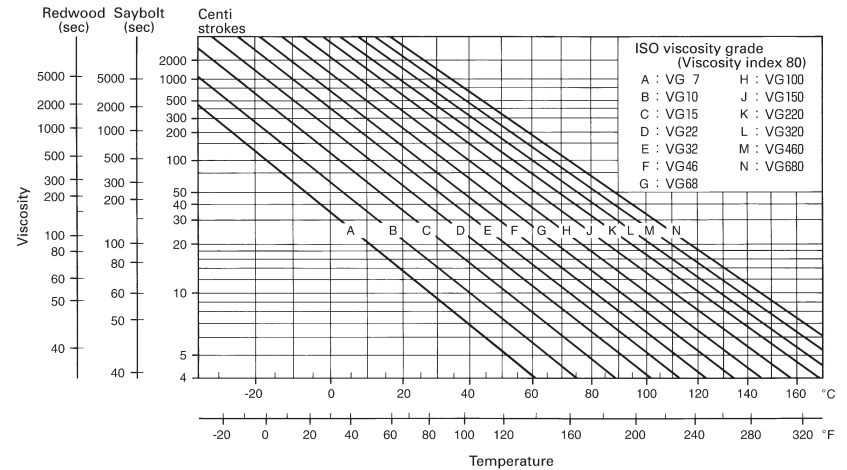

Fig. 25 Relationship between viscosity and temperature of lubricating oil

Table 38 Conditions of bearing use and examples of lubricating oil selection

Conditions	ISO viscosity grade(VG)											
	10	15	22	32	46	68	100	150	220	320	460	680
Operating temperature	-30 ~ 0°C ← Refrigerator oil →											
	0 ~ 50°C ← Bearing oil → ← Turbine oil →											
	50 ~ 80°C ← Bearing oil → ← Turbine oil →											
	80 ~ 110°C ← Turbine oil → ← Bearing oil → ← Gear oil →											
$d_m n$ value Load	Large ← Small											
	Small ← Large											

Remarks · Lubricating oils are based on JIS K 2211 (Refrigerator Oil), JIS K 2239 (Bearing Oil), JIS K 2213 (Turbine Oil), and JIS K 2219 (Gear Oil).
· The method of lubrication in these cases is mainly oil bath lubrication or circulating lubrication.
· When the temperature is on the high side within the operating temperature range, oils of high viscosity are used.
· $d_m n$ represents the mean value of the bore and outside diameters (mm) of the bearing multiplied by the rotational speed (rpm).

$$1\text{mm}=0.03937\text{inch}$$

$$1\text{N}=0.102\text{kgf}=0.2248\text{lbs.}$$

Capilube Bearing

TURNUP Capilube Bearing is a bearing that is lubricated with a newly developed thermosetting solid-type lubricant. A large amount of lubricating oil and fine particles of ultra high molecular weight polyolefin in resin are solidified by heat treatment to fill the inner space of the bearing. As the bearing rotates, the lubricating oil oozes out onto the raceway in proper quantities, maintaining the lubrication performance for a long period of time.

Capilube Bearing is available in all Needle Roller Bearing series with an outer diameter not exceeding 80 mm. When required, please consult TURNUP for further information.

Features of Capilube Bearing

- Most suitable for preventing grease dry-up in applications where lubrication is difficult.
- Great reduction of maintenance work by extending the lubrication interval.
- Elimination of oil contamination, making this bearing most suitable for applications that would be adversely affected by oil.

Cautions for using Capilube Bearing

- Never wash Capilube Bearing with organic solvent and/or white kerosene which have the ability to remove fat, or leave the bearing in contact with these agents.
- The operating temperature range is -15~+80°C. For continuous operation, the recommended operating temperature is +60°C or less.

Rotational endurance test

Test condition

Test product
 TURNUP Capilube Cam Follower: CF10/SG
 TURNUP Standard Cam Follower: CF10
 Rotational speed : 1,000rpm
 Ambient temperature : Room temperature

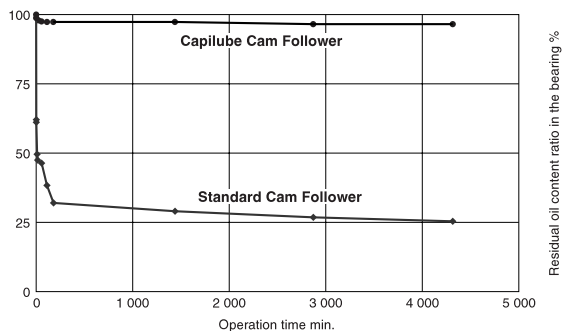

- To ensure normal rotation of the bearing, apply a load of 1% or more of the basic dynamic load rating at use.
- The allowable rotational speed is different from that of the general needle roller bearings. See the values shown in Table 39.



Structure of Capilube Bearing

Table 39 Allowable rotational speed of Capilube Bearing

Type (representative)	Allowable $d_m n$ values	
	Model code (representative)	$d_m n^{(1)}$, $d_m n^{(2)}$
Machined type needle roller bearing	NA, TR, TAF, NAF	20 000
Shell type needle roller bearing	TA...Z, TLA...Z	20 000
Cam follower	CF...W	10 000

Notes⁽¹⁾ $d_m n = (\text{bore diameter of bearing [mm]} + \text{outside diameter of bearing [mm]}) / 2 \times \text{rotational speed [rpm]}$
⁽²⁾ $d_m n = \text{stud diameter [mm]} \times \text{rotational speed [rpm]}$

Friction and Allowable Rotational Speed

Friction

Compared with sliding bearings, the starting (static) friction for rolling bearings is small, and the difference between the starting (static) friction and the kinetic friction is also small. The loss of power and temperature rise in machines are thus reduced, improving the mechanical efficiency.

Frictional torque is influenced by the bearing type, bearing load, rotational speed, lubricant characteristics, etc. It varies according to the lubricant when operated under light-loads and high-speed conditions, and according to the load when operated under heavy-loads and low-speed conditions.

Frictional torque of rolling bearings is complicated because it is influenced by various factors, but for convenience, it can be expressed approximately by the following equations.

$$\text{Radial bearings } M = \mu P \frac{d}{2} \dots\dots\dots(37)$$

$$\text{Thrust bearings } M = \mu P \frac{d_m}{2} \dots\dots\dots(38)$$

where, M : Frictional torque, N-mm

μ : Coefficient of friction

P : Bearing load, N

d : Bearing bore diameter, mm

d_m : Mean value of bearing bore and outside diameters, mm

The approximate coefficients of friction of TURNUP Bearings under operating conditions, in which lubrication and mounting are correct and where loads are relatively large and stable, are shown in Table 40.

Table 40 Coefficient of friction

Bearing series	μ
Needle roller bearings with cage	0.0010 ~ 0.0030
Full complement needle roller bearings	0.0030 ~ 0.0050
Thrust needle roller bearings	0.0030 ~ 0.0040
Thrust roller bearings	0.0030 ~ 0.0040

Allowable rotational speed

As the rotational speed of rolling bearings is increased, the bearing temperature also increases due to the heat generated at the contact surfaces between the cage, raceways and rolling elements, until it finally leads to bearing seizure. It is therefore necessary to maintain the rotational speed of a bearing below a certain limit value to ensure safe operation for long periods. This limit value is called the allowable rotational speed.

Since the amount of heat generated is approximately proportional to the sliding speed at the contact area, this sliding speed is an approximate guide indicating the limit of the bearing rotational speed.

The allowable rotational speed of bearings thus varies according to the bearing type, size, bearing load, method of lubrication, radial clearance, and other such factors.

The allowable rotational speeds shown in the table of dimensions are empirical values. They are not absolute values and can be changed according to the bearing use conditions. Depending on the structure and accuracy around the bearing, the lubricant and the lubrication method, it is possible for some bearings to be operated at more than twice the allowable rotational speed given in the table without trouble.

Operating Temperature Range

The allowable operating temperature range for needle roller bearings is generally $-20 \sim +120^{\circ}\text{C}$.

When operating at temperatures outside this range, the operation may be limited by the allowable temperature range of prepacked grease, seal, cage material, etc.

The operating temperature range for some types of bearings is different from the above. See the section for each bearing.

Handling of Bearings

Precautions in handling

Since the bearing is a high-accuracy mechanical element, special attention must be paid to its handling. The following precautions should be noted when handling the bearings.

❶ Bearings and their surrounding parts should be kept clean.
Bearings and their surrounding parts must be kept clean paying special attention to dust and dirt. Tools and the working environment should also be cleaned.

❷ Bearings should be handled carefully.
A shock load during handling may cause scratches, indentations and even cracks or chips on the raceway surfaces and rolling elements.

❸ Bearings should be mounted or dismounted with proper tools.
When mounting and dismounting, tools suitable for the bearing type should be used.

❹ Bearings should be protected against corrosion.
Bearings are treated with anti-corrosive oil. However, when handling them with bare hands, sweat from the hands may result in future rust formation. Gloves should be worn, or hands should be dipped in mineral oil.

Mounting

Preparation

Before mounting the bearing, the dimensions and fillets of the shaft and housing should be checked to ensure that they conform to specifications. Bearings should be unwrapped just before mounting. In case of grease lubrication, bearings should be filled with grease without cleaning the bearings. Even in the case of oil lubrication, it is normally unnecessary to clean the bearings. However, when high accuracy is required or when using at high speeds, the bearings should be cleaned using cleaning oil to remove thoroughly oily contents. The cleaned bearings should not be left alone without anti-corrosive precautions, because bearings can easily be corroded after anti-corrosive agents are removed. Lubricating grease is prepacked in some types of bearings. Therefore, refer to the relevant section for each bearing.

Methods of mounting

Mounting methods of bearings are different according to the type of bearing and the fit. In general, mounting of needle roller bearings is comparatively easy. However, non-separable bearings with large interferences should be handled with great care.

❶ Mounting by press fit

Small and medium bearings with small interferences require a small pressing-in force for mounting, and they are mounted using a press at room temperature. The bearing should be pressed in carefully, applying a force evenly to the bearing with a fitting tool as shown in Fig. 26. For separable bearings, the inner and outer rings can be mounted separately, and the mounting work is simple. However, when installing the shaft and inner ring assembly into the outer ring, care should be taken not to damage the raceway surfaces and rolling elements.

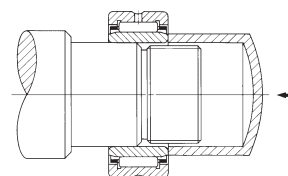

Fig. 26

When mounting non-separable bearings, the inner and outer rings are pressed in simultaneously by applying a cover plate as shown in Fig. 27. It must never happen that the inner ring is press-fitted to the shaft by striking the outer ring, or the outer ring by striking the inner ring, because the raceway surfaces and rolling elements will be scratched or indented.

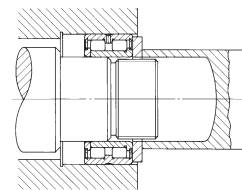

Fig. 27

When press fitting, the friction of the fitting surfaces can be reduced by applying high viscosity oil over the fitting surfaces.

The pressing-in or pulling-out force to be applied to the bearing is given on page A59.

❷ Mounting by shrink fitting

This method is used when the interference is great or when a large bearing is to be fitted. The housing is heated and thermally expanded when fitting the outer ring to the housing and the inner ring is heated and expanded when fitting it to the shaft allowing the bearing to be set easily within a short time. The maximum allowable temperature for the shrink fit is $+120^{\circ}\text{C}$, and heating should be performed appropriately. Pure non-corrosive mineral oil is recommended as the heating oil for shrink fit, and insulation oil for transformers is considered to be the best. During cooling, the bearing also shrinks in the axial direction. Therefore, to ensure that there is no clearance between the bearing and the shoulder, an axial force must be applied continuously to the bearing until it has cooled.

When the interference between the outer ring and the housing is great, an expansion fit method in which the bearing is cooled using dry ice or other cooling agent before fitting can be used. Immediately after fitting, however, moisture from the air easily condenses on the bearing. Therefore, it is necessary to take preventive measures against corrosion.

Pressing force and pulling force

Guidelines for the pressing force when pressing in the inner ring to the shaft and the pulling force when pulling it out are obtained from the following equation.

$$K = f_k \frac{d}{d+2} \Delta_{dF} B \left\{ 1 - \left(\frac{d}{F} \right)^2 \right\} \dots\dots\dots (39)$$

- where, K : Pressing or pulling force, N
 f_k : Resistance factor determined by the coefficient of friction
 When pressing in inner ring to shaft, $f_k=4 \times 10^{-4}$
 When pulling out inner ring from shaft, $f_k=6 \times 10^{-4}$
 d : Bore diameter of inner ring, mm
 Δ_{dF} : Apparent interference, mm
 B : Width of inner ring, mm
 F : Outside diameter of inner ring, mm

The actual pressing force or pulling force may be greater than the calculated value due to mounting errors. When designing a puller, it is necessary that the puller has the strength (rigidity) to withstand more than 5 times the calculated value.

Running test

After mounting the bearing, a running test is carried out to check whether the mounting is normal. Usually, it is first checked by manual turning. Then, it is operated by power gradually from no-load and low-speed up to normal operating conditions to check for abnormalities.

Noise can be checked by using a soundscope or similar instrument. In this test, checks are carried out for the following abnormalities.

1 Manual turning

- (a) Uneven torque Improper mounting
- (b) Sticking and rattling ... Scratches or indentations on the raceway surface
- (c) Irregular noise ... Penetration of dust or foreign particles

2 Power running

- (a) Abnormal noise or vibration ... Indentations on the raceway surface, too great clearance
- (b) Abnormal temperature ... Unsuitable lubricant, improper mounting, too small clearance

Dismounting

Dismounting of the bearings is carried out for the periodic inspection or repairs of machines. By inspecting the bearing, related parts or mechanisms, lubrication, etc., important data is obtained. In the same manner as in mounting, care should be taken to prevent damage to the bearing or other parts.

A suitable dismounting method should be selected according to the type of the bearing, fit, etc. Bearings mounted by interference fit are especially difficult to dismount, and it is necessary to give due consideration to the structure around the bearing during the design stage.

Dismounting of outer ring

Outer rings mounted by interference fit are dismounted as shown in Fig. 28, by screwing in the push-out bolts evenly through several screw holes provided at places corresponding to the side face of the outer ring.

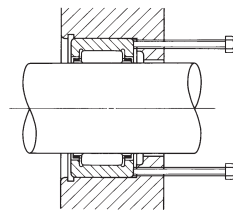

Fig. 28

Dismounting of inner ring

In the case of bearings such as needle roller bearings in which the inner and outer rings are separable, the simplest way to press out the inner ring is by using a press as shown in Fig. 29.

The puller shown in Fig. 30 is also generally used. This is designed according to the bearing size. In addition, there are a 3-hook puller (Fig. 31) and a 2-hook puller for wide-range use.

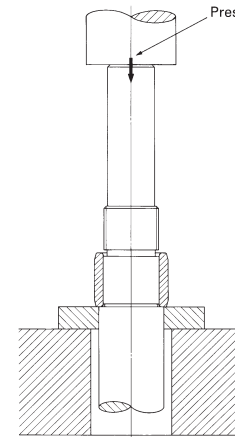

Fig. 29

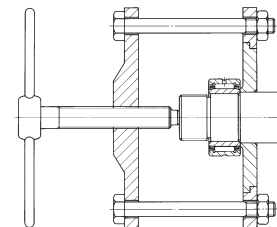

Fig. 30

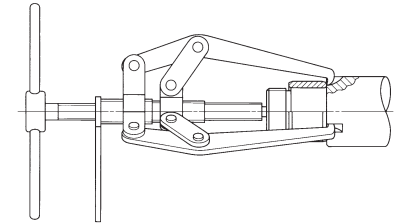

Fig. 31

In addition to these, when it is difficult to remove the inner ring due to high shoulders, several holes for removal pins are made through the shoulder, or several hook grooves are cut in the shoulder as shown in Fig. 32 and Fig. 33.

When a bearing is not to be used again after removal, it may be removed by heating with a torch lamp.

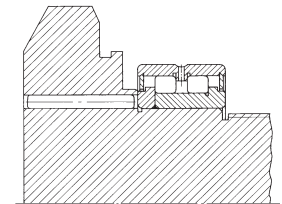

Fig. 32

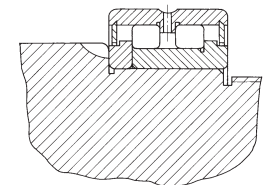

Fig. 33

1mm=0.03937inch
 1N=0.102kgf=0.2248lbs.

Inspection of bearing

Cleaning of bearing

When inspecting a bearing after removal, the appearance of the bearing should be recorded first. Then, after the residual amount of lubricant is checked and a sample of lubricant is collected, the bearing should be cleaned.

For cleaning, light oil or kerosene is commonly used. Cleaning is divided into rough cleaning and final cleaning, and wire gauze is set as a raised bottom in a container to prevent the bearing from touching the bottom of the container.

Lubricating grease and adhering substances such as foreign particles are removed with a brush, etc., using oil for rough cleaning. Care should be taken during this process, because if the bearing is turned with foreign particles attached, the raceway surfaces may be scratched.

Final cleaning is carried out by turning the bearing in cleaning oil. It is desirable that the cleaning oil is kept clean by filtering. Immediately after cleaning, the bearing must be protected against corrosion.

Inspection and evaluation of bearing

The judgement as to whether the removed bearing is reusable depends on the inspection after cleaning. Conditions of the raceway surfaces, rolling elements and fitting surfaces, wear condition of the cage, increase of bearing clearance, dimensions, rotational accuracy, etc. should be checked for damage and abnormalities.

The evaluation is performed based on the experience taking into consideration the degree of damage, machine performance, importance of the machine, operating conditions, period until the next inspection, and other such factors.

Maintenance and inspection

Maintenance and inspection

Maintenance and inspection are carried out to maintain good performance of bearings installed in the machine.

Maintenance is performed by checking the machine operating conditions, checking and replenishing or replacing the lubricant, checking the bearing and related parts by periodic disassembly and other such procedures.

Items for inspection of a running bearing in a machine include the bearing temperature, noise, vibration and condition of lubricant.

When any abnormality is found during operation, the cause should be investigated and measures taken by referring to the section on running test on page 62. When removing a bearing, refer to the section on dismounting on page A59.

Damage, causes and corrective action

Rolling bearings can generally be used fully up to their rolling fatigue life if they are properly selected, mounted, operated and maintained. However, they may actually be damaged earlier than their expected lifetimes creating problems or accidents. Common causes of damage include improper mounting or handling, insufficient lubrication and penetration of foreign particles.

It may be difficult to determine the exact cause of a problem by checking only the damaged bearing. The conditions of the machine before and after the occurrence of the damage, the location and the operating and ambient conditions of the bearing, the structure around the bearing, etc. should also be examined. It then becomes possible to assess the cause of the damage by linking the conditions of the damaged bearing to the probable causes arising from the machine operation, and to prevent the recurrence of similar problems.

Common types of damage, causes and corrective action are listed in Table 41.

Table 41 Damage, causes and corrective action

Condition of bearing damage		Cause	Corrective action
Flaking	Flakings at opposite circumferential positions on raceway surfaces	Improper roundness of housing bore	Correction of housing bore accuracy
	Flakings in the vicinity of raceway surface edges and roller ends	Improper mounting, Shaft deflection, Poor centering, Poor accuracy of shaft or housing	Careful mounting, Careful centering, Correction of shoulders of shaft and housing for right angles
	Flakings on raceway surfaces with an interval corresponding to roller pitch	Great shock load when mounting, Rusting during machine stoppage	Careful mounting, Protection against rust for long periods of machine stoppage
Galling	Early flaking on raceway surfaces and rolling elements	Too small clearance, Too great load, Poor lubrication, Rusting, etc.	Correct selection of fit and clearance Correct selection of lubricant
	Galling on raceway surfaces and rolling surfaces of rollers	Poor lubrication in early stage Grease consistency too hard High acceleration at start	Selection of softer grease, Avoiding quick acceleration
Breakage	Galling between roller end faces and collar guide surfaces	Poor lubrication, Poor mounting, Large axial load	Correct selection of lubricant Correct mounting
	Cracks in outer or inner ring	Excessive shock load, Too much interference. Poor cylindricity of shaft. Too large fillet radius, Development of thermal cracks, Development of flaking	Reevaluation of load conditions, Correction of fit, Correction of machining accuracy of shaft or sleeve, Making fillet radius smaller than the chamfer dimension of bearing
Dent	Cracked rolling elements, broken collar	Development of flaking Shock to collar when mounting, Dropped by careless handling	Careful handling and mounting
	Broken cage	Abnormal load to cage by poor mounting, Poor lubrication	Minimizing mounting errors, Study of lubricating method and lubricant
Abnormal wear	Indentations on raceway surfaces at an interval corresponding to the pitch between rolling elements (brinelling)	Shock load applied when mounting, Excessive load while stopping	Careful handling
	Indentation on raceway surfaces and rolling surfaces of rollers	Biting of foreign substances such as metal chips and sands	Cleaning of housing, Improvement of sealing, Use of clean lubricant
Seizure	False brinelling (Phenomenon like brinelling)	Vibration when the bearing is stationary such as during transportation, Oscillating motion with small amplitude	Fixing of shaft and housing, Use of lubricating oil, Application of preload to reduce vibration
	Fretting Localized wear of fitted surfaces accompanied by red-brown wear particles	Sliding between fitted surfaces	Increase of interference, Application of oil
	Wear on raceway surfaces, collar surfaces, rolling surfaces of rollers, cages, etc.	Penetration of foreign particles, Poor lubrication, Rust	Improvement of sealing, Cleaning of housing Use of clean lubricant
Electric corrosion	Creep Wear on fitted surfaces	Sliding between fitted surfaces, Insufficient tightening of sleeve	Increase of interference, Correct tightening of sleeve
	Discoloration of rolling elements and/or raceway surfaces and/or flange surfaces, Adhesion and welding, Discoloration of cage	Poor lubrication, Too small clearance, Poor mounting	Supply of proper amount of proper lubricant, Rechecking of fit and bearing clearance Rechecking of mounting dimensions and related parts
Rust, corrosion	Ripples on raceway surfaces	Melting by sparks due to electric current	Insulation of bearing, Grounding to avoid electric current
	Rust or corrosion on bearing inside surfaces or on fitted surfaces	Condensation of vapor in air, Penetration of corrosive substances	Careful storage if under high temperature and high humidity, Protection against rust, Improvement of sealing



Description of Each Series & Table of Dimensions

Shell Type Needle Roller Bearings	TA · TLA · BA · BHA	B1
Needle Roller Cages for general usage	KT	C1
Needle Roller Cages for engine connecting rods	KT···EG · KTV···EG	C17
Machined Type Needle Roller Bearings	TAF···/SG · NA · TAFI · TRI · BRI	D1
Needle Roller Bearings with separable cage	NAF	D93
Roller Bearings	NAG · NAU · TRU · NAS	E1
Thrust Bearings	NTB · AS · AZK · WS · GS	F1
Combined Type Needle Roller Bearings	NAX · NBX · NATA · NATB	G1
Inner Rings	IRT · IRB · LRT · LRB	H1
Cam Followers	CF···/SG · CF · NUCF · CFS · CR	I1
Roller Followers	NAST · NART · NURT	I83
Crossed Roller Bearings	CRBF · CRBH · CRBC · CRB · CRBS	J1
Spherical Bushings	SB · GE · SBB	K1
Pilloballs	PB · PHS · POS · PHSB · POSB · PHSA	K29
L-balls	LHSA · LHS	K45
Super Flexible Nozzles	SNA · SNM · SNPT	K55
Parts For Needle Roller Bearings	OS · DS · WR · AR · Needle Roller	L1

SHELL TYPE NEEDLE ROLLER BEARINGS

- Shell Type Caged Needle Roller Bearings
- Shell Type Grease Retained Full Complement Needle Roller Bearings



Structure and features

TURNUP Shell Type Needle Roller Bearings are light weight bearings with large load ratings. They employ a shell type outer ring made from a thin special-steel plate which is accurately drawn, carburized and quenched, thus providing the lowest sectional height among the needle roller bearings.

There are two types of bearings available in this series; the caged type and the full complement type. The appropriate type can be selected according to the operating conditions. The caged type has a structure in which the needle rollers are accurately guided by the cage and thrust rings. It is useful for applications at high-speed rotation. The full complement type needle roller bearing, on the other hand, is suitable for heavy-load applications at low-speed rotation.

Since these bearings are press-fitted into the housing, no fixtures for axial positioning are needed. They are ideal for use in mass-produced articles that require economy, and have a wide variety of applications.

Structures of Shell Type Needle Roller Bearings

Standard Caged Type

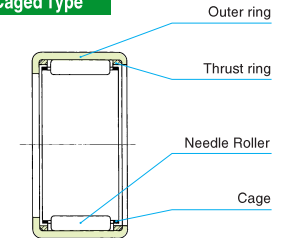

Caged and closed end type

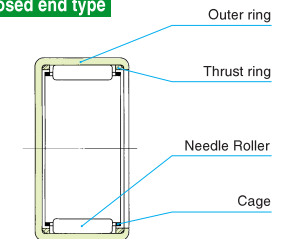

Caged type with two seals

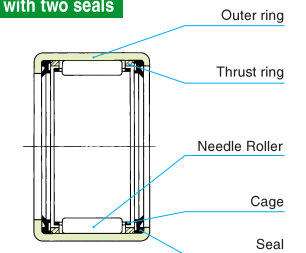

Grease retained full complement type

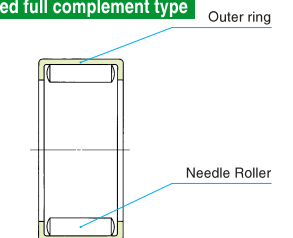

B

TA
TLA
BA
BHA

Types

Numerous varieties of Shell Type Needle Roller Bearings are available as shown in Table 1.

Table 1 Type of bearing

Series	Type	Caged			Full complement
		Standard	Closed end	With seals ⁽¹⁾	
Metric series	—	TLA ... Z	TLAM	TLA ... UU	YTL
	Heavy duty	TA ... Z	TAM	—	YT
Inch series	—	BA ... Z	BAM	—	YB
	Heavy duty	BHA ... Z	BHAM	—	YBH

Note⁽¹⁾ When the heavy duty type with seals or the closed end type with one seal is required, please consult TURNUP.

Remark A "W" is added to the model code to indicate that the rolling elements are of the double-row type.
Example TAW 5045 Z

Shell Type Caged Needle Roller Bearings

Standard type

This type has a narrow gap between the bore of the marked-side flange of the outer ring (brand, bearing number, etc. are marked) and the shaft, which prevents grease leaks and the entry of foreign particles. This type has wide applications.

Closed end type

This type is completely closed on one side of the outer ring, and is ideal for use when perfect closing of shaft ends is desired.

The shape of the closed end surface of the outer ring is divided into two types, and the dimensions t_1 and t_2 in the illustrations shown in the dimension tables apply to the bearings with the roller set bore diameters, $F_w > 22$ and $F_w \leq 22$, respectively.

Type with seals at both sides

This type has a wider outer ring than the standard type and is installed with seals consisting of a reinforcing ring and special synthetic rubber to prevent grease leaks and the entry of foreign particles.

Shell Type Grease Retained Full Complement Needle Roller Bearings

This type has full complement rollers which extend to the full width of the outer ring raceway. It can, therefore, withstand heavy bearing loads and is most suitable for low and medium rotational speeds as well as rocking motions. As lubricating grease is prepacked with the rollers, the bearing can be operated immediately after being fitted.

Identification Number

The identification number of Shell Type Needle Roller Bearings consists of a model code and dimensions. Examples of the arrangement are shown below.

When using with inner rings, the assembled inner rings shown in the dimension tables are used. An example in this case is also shown below. Inner rings are delivered separately.

Examples of identification number

Example 1

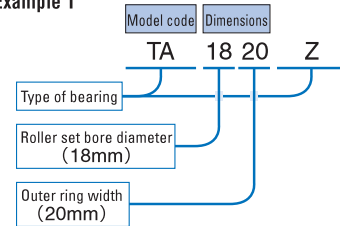

Example 2 (With inner ring)

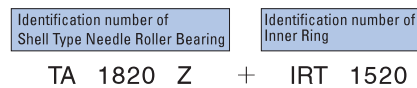

Accuracy

The outer rings of Shell Type Needle Roller Bearings are thin and therefore cannot avoid deformation due to heat treatment. It is thus not appropriate to take direct measurements of the bearing. The roller set bore diameter is measured using a plug gauge or tapered gauge after press-fitting the bearing to a suitable ring gauge. The gauge specifications are shown in Tables 2.1 and 2.2.

Tolerances of outer ring width C are shown in Table 3.

Table 2.1 Measuring gauges for metric series bearings unit: mm

F_w Nominal roller set bore diameter	Ring gauge		Plug gauge	
	TA ... Z ⁽¹⁾	TLA ... Z ⁽²⁾	Go	No-go
4	—	7.981	4.004	4.016
5	—	8.981	5.004	5.016
6	—	9.981	6.004	6.016
7	—	10.977	7.005	7.020
8	14.992	11.977	8.005	8.020
9	15.992	12.977	9.005	9.020
10	16.992	13.977	10.005	10.020
12	18.991	15.977 ⁽³⁾ 17.977 ⁽³⁾	12.006	12.024
13	—	18.972	13.006	13.024
14	21.991	19.972	14.006	14.024
15	21.991	20.972	15.006	15.024
16	23.991	21.972	16.006	16.024
17	23.991	22.972	17.006	17.024
18	24.991	23.972	18.006	18.024
19	26.991	—	19.007	19.028
20	26.991 ⁽⁴⁾ 27.991 ⁽⁴⁾	25.972	20.007	20.028
21	28.991	—	21.007	21.028
22	28.991 ⁽⁵⁾ 29.991 ⁽⁵⁾	27.972	22.007	22.028
24	30.989 ⁽⁶⁾ 31.989 ⁽⁶⁾	—	24.007	24.028
25	32.989	31.967	25.007	25.028
26	33.989	—	26.007	26.028
28	36.989	34.967	28.007	28.028
29	37.989	—	29.007	29.028
30	39.989	36.967	30.007	30.028
32	41.989	—	32.009	32.034
35	44.989	41.967	35.009	35.034
37	46.989	—	37.009	37.034
38	47.989	—	38.009	38.034
40	49.989	46.967	40.009	40.034
45	54.988	51.961	45.009	45.034
50	61.988	57.961	50.009	50.034
55	66.988	62.961	55.010	55.040
60	71.988	—	60.010	60.040
62	73.988	—	62.010	62.040
65	76.988	—	65.010	65.040
70	81.987	—	70.010	70.040

- Notes⁽¹⁾ Also applicable to TAM and YT
⁽²⁾ Also applicable to TLAM, YTL, TLA...UU
⁽³⁾ The upper value is for TLA 1210Z model, and the lower value is for TLA 1212Z model.
⁽⁴⁾ The lower value is for TA 202820Z model, and the upper value is for models other than TA 202820Z model.
⁽⁵⁾ The lower value is for TA 223016Z and TA 223020Z models, and the upper value is for models other than those models.
⁽⁶⁾ The lower value is for TA 243216Z and TA 243220Z models, and the upper value is for models other than those models.

Table 2.2 Measuring gauges for inch series bearings unit: mm

F_w Nominal roller set bore diameter	Ring gauge		Plug gauge	
	BA ... Z ⁽¹⁾	BHA ... Z ⁽²⁾	Go	No-go
3.969	7.155	—	3.990	4.016
4.762	8.730	—	4.783	4.808
6.350	11.125	—	6.388	6.414
7.938	12.713	14.300	7.976	8.001
9.525	14.300	15.888	9.563	9.588
11.112	15.888	17.475	11.151	11.176
12.700	17.475	19.063	12.738	12.764
14.288	19.063	20.650	14.326	14.351
15.875	20.650	22.238	15.913	15.938
17.462	22.238	23.825	17.501	17.526
19.050	25.387	26.975	19.063	19.088
20.638	26.975	28.562	20.650	20.676
22.225	28.562	30.150	22.238	22.263
23.812	30.150	—	23.825	23.851
25.400	31.737	33.325	25.413	25.438
26.988	33.325	—	27.000	27.026
28.575	34.912	38.087	28.588	28.613
30.162	38.087	—	30.175	30.201
31.750	38.087	41.262	31.763	31.788
33.338	41.262	—	33.350	33.378
34.925	41.262	44.437	34.938	34.966
38.100	47.612	—	38.113	38.143
41.275	50.787	—	41.288	41.318
44.450	53.962	57.137	44.463	44.496
47.625	57.137	—	47.638	47.671
50.800	60.312	—	50.815	50.848
52.388	—	64.280	52.413	52.451
53.975	63.487	—	53.990	54.028
57.150	66.662	—	57.165	57.203
66.675	76.187	—	66.700	66.738
69.850	79.362	—	69.875	69.914

- Notes⁽¹⁾ Also applicable to BAM and YB
⁽²⁾ Also applicable to BHAM and YBH

Table 3 Tolerances of outer ring width C unit: mm

Series	Tolerance
Metric	0 ~ -0.20
Inch	0 ~ -0.25

1N=0.102kgf=0.2248lbs.
1mm=0.03937inch

Fit

As the outer ring is thin, the correct dimensions and accuracy of Shell Type Needle Roller Bearings are obtained only after they have been press-fitted into the housing bore. Bearing accuracy is directly affected by housing dimensions, shape and rigidity. This should be taken into account when considering fit and accuracy. The radial clearance after fitting the bearing to the shaft and the housing bore varies with their tolerances.

Table 4 shows the recommended fit for Shell Type Needle Roller Bearings.

Table 5 shows a calculation example of radial clearance after fitting. This calculation applies to bearings without inner ring to be fitted into rigid steel or cast iron housings. When the housing is made of light alloy or a thin steel pipe, it is necessary to check dimensions by actual measurement.

Generally, when making the radial clearance smaller, it is recommended that the shaft diameter be increased, without decreasing the housing bore diameter.

Table 4 Recommended fit

Type of bearing	Housing material	Tolerance class		
		Shaft (1)		Housing bore
		Without inner ring	With inner ring	
TA...Z, BA...Z, BHA...Z, TAM, BAM, BHAM, YT, YB, YBH	Steel Cast iron	h6	k5(j5)	J7
	Light alloy (Thin steel pipe)	h6	k5(j5)	M7(N7)
TLA...Z, TLAM, YTL, TLA...UU	Steel Cast iron	h6	k5(j5)	N7
	Light alloy (Thin steel pipe)	h6	k5(j5)	R7(S7)

Note(1) When housings are made of light alloy or a thin steel pipe, the roller set bore diameter is greatly affected by the housing thickness and shape. Therefore, before mass-production assembly, assembly tests should be carried out to confirm the amount of dimensional change and to determine the tolerance of the shaft which will give normal clearances.

Table 5 Calculation example of radial clearance after fitting

unit: mm

Calculation procedure	Example of TLA 2020 Z
1 Dimension of roller set bore diameter of bearing after it has been press-fitted into the ring gauge. Dimension of ring gauge (D_0): See Tables 2.1 and 2.2 on page B4. Max. value of roller set bore dia. ($F_{w \max}$): No-go dimension of plug gauge Min. value of roller set bore dia. ($F_{w \min}$): Go dimension of plug gauge	From Table 2.1 on page B4 $D_0 = 25.972$ $F_{w \max} = 20.028$ $F_{w \min} = 20.007$
2 Dimension of housing bore Max. value of housing bore (D_{\max}): See the dimension table. Min. value of housing bore (D_{\min}): See the dimension table.	From the dimension table on page B14, $D_{\max} = 25.993$ $D_{\min} = 25.972$
3 Dimension of roller set bore diameter of bearing after it has been press-fitted into the housing bore Max. value of roller set bore dia. ($F_{w \max}$) = $(D_{\max} - D_0) + F_{w \max}$ Min. value of roller set bore dia. ($F_{w \min}$) = $(D_{\min} - D_0) + F_{w \min}$	From the equations, $F_{w \max} = 20.049$ $F_{w \min} = 20.007$
4 Dimension of shaft Max. value of shaft dia. (F_{\max}): See the dimension table. Min. value of shaft dia. (F_{\min}): See the dimension table.	From the dimension table on page B14, $F_{\max} = 20.000$ $F_{\min} = 19.987$
5 Radial clearance after mounting Max. value of radial clearance ($G_{r \max}$) = $F_{w \max} - F_{\min}$ Min. value of radial clearance ($G_{r \min}$) = $F_{w \min} - F_{\max}$	From the equations, $G_{r \max} = 0.062$ $G_{r \min} = 0.007$ The radial clearance after mounting becomes 0.007~0.062 mm.

D : Housing bore diameter
 F_w : Roller set bore diameter
 F : Shaft diameter
 G_r : Radial clearance

Lubrication

Bearings with prepacked grease are shown in Table 6. ALVANIA GREASE S2 (SHELL) is prepacked as the lubricating grease.

In the case of bearings without prepacked grease, perform proper lubrication for use. If the bearings are operated without lubrication, the wear of the roller contact surfaces will increase and the bearing life will be shortened.

Oil Hole

For Shell Type Needle Roller Bearings with an oil hole, "OH" is appended to the end of the identification number.

Example TA 2525 Z OH
The symbol "OH" is not marked on the bearing itself, but is shown on its packaging, etc. When bearings with multiple oil holes are required, please consult

Table 6 Bearings with prepacked grease

○ : With prepacked grease × : Without prepacked grease

Series	Bearing type	Caged			Full complement Grease retained
		Standard	Closed end	With seals	
Metric series	TLA, TLAM, YTL	×	×	○	○
	TA, TAM, YT	×	×	—	○
Inch series	BA, BAM, YB	×	×	—	○
	BHA, BHAM, YBH	×	×	—	○

Static Safety Factor

Since Shell Type Needle Roller Bearings employ an outer ring made from a thin steel plate which is drawn, carburized and quenched, excessively large loads must be avoided. The required static safety factor is usually more than 3.

Specifications of shaft and housing

Shell Type Needle Roller Bearings are commonly used without an inner ring. In such cases, the surface hardness of the raceway surface should be 58~64HRC and the surface roughness should not exceed $0.2 \mu m R_a$. However, when the operating condition is not severe, a surface roughness $0.8 \mu m R_a$ or less can be used.

If the surface hardness is low, the load rating must be corrected by the hardness factor shown on page A20. When the shaft cannot be heat treated and finished by grinding, the use of TURNUP Inner Rings for Shell Type Needle Roller Bearings (See page H1.) is recommended.

Mounting

Shell Type Needle Roller Bearings should be pressed into the housings gently using the appropriate tool as shown in Fig. 1, with their marked end surface up. As the outer ring is thin, it must never be struck directly with a hammer.

Since the outer rings of Shell Type Needle Roller Bearings are firmly fitted to housing bores with interference, it is unnecessary to fix them axially. Fig. 2 shows mounting examples.

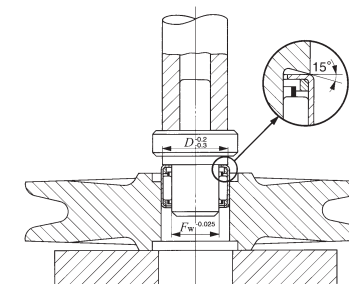

Fig.1 Example of mounting tool

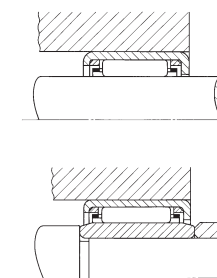

Fig.2 Mounting examples

$1N=0.102kgf=0.2248lbs.$
 $1mm=0.03937inch$

SHELL TYPE NEEDLE ROLLER BEARINGS



Shaft dia. 4 – 10mm

Shaft dia. mm	Identification number									
	Standard	Mass (Ref.) g	Closed end	Mass (Ref.) g	Standard	Mass (Ref.) g	Closed end	Mass (Ref.) g	Grease retained	Mass (Ref.) g
4	—	—	—	—	TLA 48 Z	1.54	TLAM 48	1.67	—	—
	—	—	—	—	—	—	—	—	YTL 48	1.73
5	—	—	—	—	TLA 59 Z	1.9	TLAM 59	2	—	—
	—	—	—	—	—	—	—	—	YTL 59	2.4
6	—	—	—	—	TLA 69 Z	2.2	TLAM 69	2.3	—	—
7	—	—	—	—	TLA 79 Z	2.5	TLAM 79	2.7	—	—
8	—	—	—	—	TLA 810 Z	3.1	TLAM 810	3.3	—	—
	TA 810 Z	6.7	TAM 810	7.1	—	—	—	—	—	—
	TA 815 Z	9.7	TAM 815	10.1	—	—	—	—	—	—
	TA 820 Z	12.9	TAM 820	13.3	—	—	—	—	—	—
	—	—	—	—	—	—	—	—	YT 810	7.7
9	—	—	—	—	TLA 910 Z	3.4	TLAM 910	3.6	—	—
	—	—	—	—	TLA 912 Z	4	TLAM 912	4.3	—	—
	TA 912 Z	8.7	TAM 912	9.2	—	—	—	—	—	—
	TA 916 Z	11.4	TAM 916	11.9	—	—	—	—	—	—
	—	—	—	—	—	—	—	—	YT 912	10.1
10	—	—	—	—	TLA 1010 Z	3.7	TLAM 1010	4	—	—
	—	—	—	—	TLA 1012 Z	4.4	TLAM 1012	4.8	—	—
	—	—	—	—	TLA 1015 Z	5.5	TLAM 1015	5.9	—	—
	TA 1010 Z	7.9	TAM 1010	8.5	—	—	—	—	—	—
	TA 1012 Z	9.3	TAM 1012	10	—	—	—	—	—	—
	TA 1015 Z	11.5	TAM 1015	12.2	—	—	—	—	—	—
	TA 1020 Z	15.4	TAM 1020	16	—	—	—	—	—	—

Note(1) Allowable rotational speed applies to oil lubrication. For grease lubrication, a maximum of 60% of this value is allowable.
Remark Shell Type Grease Retained Full Complement Needle Roller Bearings are provided with prepacked grease. Standard type and closed end type bearings are not provided with prepacked grease, so perform proper lubrication when using these types of bearings.

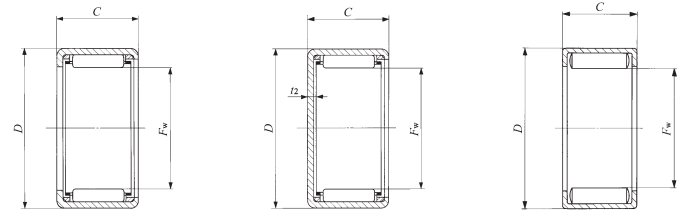

TA...Z TLA...Z

TAM TLAM

YT YTL

F _w	Boundary dimensions mm		Standard mounting dimensions mm						Basic dynamic load rating C	Basic static load rating C ₀	Allowable rotational speed ⁽¹⁾ rpm	Assembled inner ring	
	D	C	Shaft dia. h6		Housing bore dia. J7		N7						
	Max.	t ₂ Max.	Max.	Min.	Max.	Min.	Max.	Min.					
4	8	8	1	—	—	—	—	—	1 350	1 010	75 000	—	
4	8	8	—	4.000	3.992	—	—	7.996	7.981	3 010	2 900	40 000	—
5	9	9	1	—	—	—	—	—	—	—	—	—	
5	9	9	—	5.000	4.992	—	—	8.996	8.981	1 880	1 600	65 000	—
										4 320	4 750	30 000	—
6	10	9	1	6.000	5.992	—	—	9.996	9.981	2 100	1 900	55 000	—
7	11	9	1	7.000	6.991	—	—	10.995	10.977	2 490	2 450	50 000	—
8	12	10	1	8.000	7.991	—	—	11.995	11.977	3 320	3 670	45 000	—
8	15	10	1.3	—	—	—	—	—	—	3 470	2 880	45 000	—
8	15	15	1.3	8.000	7.991	15.010	14.992	—	—	5 780	5 570	45 000	—
8	15	20	1.3	—	—	—	—	—	—	8 340	8 920	45 000	—
8	15	10	—	—	—	—	—	—	—	7 530	7 950	19 000	—
9	13	10	1	9.000	8.991	—	—	12.995	12.977	3 500	4 040	45 000	—
9	13	12	1	—	—	—	—	—	—	4 460	5 510	45 000	—
9	16	12	1.3	—	—	—	—	—	—	5 140	4 880	45 000	—
9	16	16	1.3	9.000	8.991	16.010	15.992	—	—	6 960	7 210	45 000	—
9	16	12	—	—	—	—	—	—	—	9 690	11 200	17 000	—
10	14	10	1	—	—	—	—	—	—	3 870	4 740	40 000	IRT 710
10	14	12	1	10.000	9.991	—	—	13.995	13.977	4 920	6 460	40 000	IRT 712
10	14	15	1	—	—	—	—	—	—	6 390	9 040	40 000	IRT 715
10	17	10	1.3	—	—	—	—	—	—	4 150	3 780	40 000	IRT 710
10	17	12	1.3	10.000	9.991	17.010	16.992	—	—	5 590	5 540	40 000	IRT 712
10	17	15	1.3	—	—	—	—	—	—	6 920	7 300	40 000	IRT 715
10	17	20	1.3	—	—	—	—	—	—	9 990	11 700	40 000	—

1N=0.102kgf=0.2248lbs.
1mm=0.03937inch

SHELL TYPE NEEDLE ROLLER BEARINGS



Shaft dia. 12 – 15 mm

Shaft dia. mm	Identification number									
	Standard	Mass (Ref.) g	Closed end	Mass (Ref.) g	Standard	Mass (Ref.) g	Closed end	Mass (Ref.) g	Grease retained	Mass (Ref.) g
12	—	—	—	—	TLA 1210 Z	4.3	TLAM 1210	4.7	—	—
	—	—	—	—	—	—	—	—	YTL 1210	5.1
	—	—	—	—	TLA 1212 Z	8.6	TLAM 1212	9.4	—	—
	TA 1212 Z	10.5	TAM 1212	11.5	—	—	—	—	—	—
	TA 1215 Z	13.1	TAM 1215	14	—	—	—	—	—	—
12	TA 1220 Z	17.3	TAM 1220	18.3	—	—	—	—	—	—
	TA 1225 Z	21.5	TAM 1225	22.5	—	—	—	—	—	—
	—	—	—	—	—	—	—	—	YT 1212	12.8
13	—	—	—	—	TLA 1312 Z	9.2	TLAM 1312	10.1	—	—
14	—	—	—	—	TLA 1412 Z	9.8	TLAM 1412	10.8	—	—
	—	—	—	—	TLA 1416 Z	13.2	TLAM 1416	14.3	—	—
	TA 1416 Z	18.4	TAM 1416	19.6	—	—	—	—	—	—
14	TA 1420 Z	23	TAM 1420	24	—	—	—	—	—	—
	—	—	—	—	TLA 1512 Z	10.4	TLAM 1512	11.5	—	—
15	—	—	—	—	TLA 1516 Z	14	TLAM 1516	15.2	—	—
	—	—	—	—	TLA 1522 Z	19.1	TLAM 1522	20.5	—	—
	TA 1510 Z	10.8	TAM 1510	12.3	—	—	—	—	—	—
	TA 1512 Z	12.9	TAM 1512	14.3	—	—	—	—	—	—
	TA 1515 Z	15.9	TAM 1515	17.3	—	—	—	—	—	—
	TA 1520 Z	21	TAM 1520	22.5	—	—	—	—	—	—
	TA 1525 Z	25	TAM 1525	26.5	—	—	—	—	—	—
	—	—	—	—	—	—	—	—	—	—
	—	—	—	—	—	—	—	—	—	—
	—	—	—	—	—	—	—	—	—	—

Note⁽¹⁾ Allowable rotational speed applies to oil lubrication. For grease lubrication, a maximum of 60% of this value is allowable.
Remark Shell Type Grease Retained Full Complement Needle Roller Bearings are provided with prepacked grease. Standard type and closed end type bearings are not provided with prepacked grease, so perform proper lubrication when using these types of bearings.

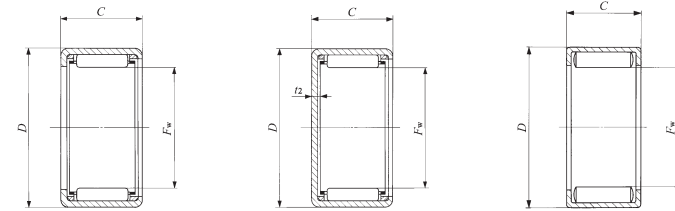

TA...Z TLA...Z

TAM TLAM

YT YTL

Boundary dimensions mm				Standard mounting dimensions mm						Basic dynamic load rating	Basic static load rating	Allowable rotational speed ⁽¹⁾	Assembled inner ring
F_w	D	C	f_2 Max.	Shaft dia. h6		Housing bore dia. J7 N7				N	N	rpm	
				Max.	Min.	Max.	Min.	Max.	Min.				
12	16	10	1	12.000	11.989	—	—	15.995	15.977	4 350	5 810	35 000	IRT 810
12	16	10	—	—	—	—	—	—	—	7 470	11 800	13 000	IRT 810
12	18	12	1.3	12.000	11.989	—	—	17.995	17.977	6 420	7 490	35 000	IRT 812
12	19	12	1.3	—	—	—	—	—	—	6 000	6 310	35 000	IRT 812
12	19	15	1.3	—	—	—	—	—	—	7 440	8 320	35 000	IRT 815
12	19	20	1.3	12.000	11.989	19.012	18.991	—	—	10 700	13 300	35 000	—
12	19	25	1.3	—	—	—	—	—	—	13 800	18 300	35 000	—
12	19	12	—	—	—	—	—	—	—	11 800	15 200	13 000	IRT 812
13	19	12	1.3	13.000	12.989	—	—	18.993	18.972	6 760	8 170	30 000	IRT 1012
14	20	12	1.3	14.000	13.989	—	—	19.993	19.972	7 080	8 840	30 000	IRT 1012-2
14	20	16	1.3	—	—	—	—	—	—	8 950	12 000	30 000	IRT 1016-2
14	22	16	1.3	14.000	13.989	22.012	21.991	—	—	10 500	12 000	30 000	IRT 1016-2
14	22	20	1.3	—	—	—	—	—	—	13 900	17 200	30 000	IRT 1020-2
15	21	12	1.3	15.000	14.989	—	—	20.993	20.972	7 380	9 520	25 000	IRT 1212
15	21	16	1.3	—	—	—	—	—	—	9 330	12 900	25 000	IRT 1216
15	21	22	1.3	—	—	—	—	—	—	13 600	20 900	25 000	IRT 1222
15	22	10	1.3	15.000	14.989	22.012	21.991	—	—	5 290	5 680	25 000	IRT 1010-1
15	22	12	1.3	—	—	—	—	—	—	7 120	8 310	25 000	IRT 1012-1
15	22	15	1.3	—	—	—	—	—	—	8 830	11 000	25 000	IRT 1015-1
15	22	20	1.3	—	—	—	—	—	—	12 700	17 600	25 000	IRT 1020-1
15	22	25	1.3	—	—	—	—	—	—	16 300	24 200	25 000	IRT 1025-1

1N=0.102kgf=0.2248lbs.
1mm=0.03937inch

SHELL TYPE NEEDLE ROLLER BEARINGS



Shaft dia. 16 – 19mm

Shaft dia. mm	Identification number									
	Standard	Mass (Ref.) g	Closed end	Mass (Ref.) g	Standard	Mass (Ref.) g	Closed end	Mass (Ref.) g	Grease retained	Mass (Ref.) g
16	—	—	—	—	TLA 1612 Z	10.9	TLAM 1612	12.2	—	—
	—	—	—	—	TLA 1616 Z	14.8	TLAM 1616	16.1	—	—
	—	—	—	—	TLA 1622 Z	20	TLAM 1622	21.5	—	—
	TA 1616 Z TA 1620 Z	20 25	TAM 1616 TAM 1620	22 27	—	—	—	—	—	—
17	—	—	—	—	TLA 1712 Z	11.5	TLAM 1712	13	—	—
	TA 1715 Z	17.6	TAM 1715	19.5	—	—	—	—	—	—
	TA 1720 Z	23.5	TAM 1720	25	—	—	—	—	—	—
	TA 1725 Z	29	TAM 1725	31	—	—	—	—	—	—
	—	—	—	—	—	—	—	—	YT 1715	20.5
	—	—	—	—	—	—	—	—	YT 1725	35.5
18	—	—	—	—	TLA 1812 Z	12	TLAM 1812	13.7	—	—
	—	—	—	—	TLA 1816 Z	16.2	TLAM 1816	17.9	—	—
	TA 1813 Z	16.4	TAM 1813	18.5	—	—	—	—	—	—
	TA 1815 Z	18.5	TAM 1815	20.5	—	—	—	—	—	—
	TA 1817 Z	21	TAM 1817	23	—	—	—	—	—	—
	TA 1819 Z	23.5	TAM 1819	25.5	—	—	—	—	—	—
	TA 1820 Z TA 1825 Z	24.5 30.5	TAM 1820 TAM 1825	26.5 32.5	—	—	—	—	—	—
19	TA 1916 Z	23	TAM 1916	25.5	—	—	—	—	—	—
	TA 1920 Z	29	TAM 1920	31	—	—	—	—	—	—

Note⁽¹⁾ Allowable rotational speed applies to oil lubrication. For grease lubrication, a maximum of 60% of this value is allowable.
Remark Shell Type Grease Retained Full Complement Needle Roller Bearings are provided with prepacked grease. Standard type and closed end type bearings are not provided with prepacked grease, so perform proper lubrication when using these types of bearings.

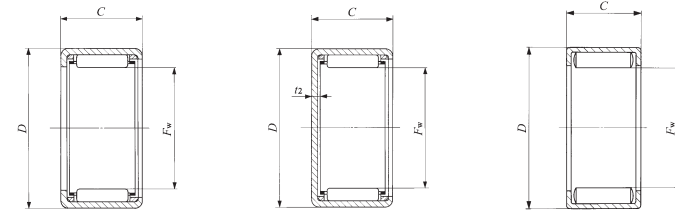

TA...Z TLA...Z

TAM TLAM

YT

F_w	Boundary dimensions mm			Standard mounting dimensions mm						Basic dynamic load rating C	Basic static load rating C ₀	Allowable rotational speed ⁽¹⁾ rpm	Assembled inner ring
	D	C	t_2 Max.	Shaft dia. h6		Housing bore dia.							
	Max.	Min.	Max.	Min.	Max.	Min.	Max.	Min.					
16	22	12	1.3	Max.	Min.	Max.	Min.	Max.	Min.	N	N	rpm	IRT 1212-1
16	22	16	1.3	16.000	15.989	—	—	21.993	21.972	7 670	10 200	25 000	IRT 1216-1
16	22	22	1.3	—	—	—	—	—	—	9 700	13 800	25 000	IRT 1222-1
16	24	16	1.3	16.000	15.989	24.012	23.991	—	—	14 200	22 400	25 000	—
16	24	20	1.3	—	—	—	—	—	—	11 100	13 300	25 000	IRT 1216-1
16	24	20	1.3	—	—	—	—	—	—	14 700	19 100	25 000	IRT 1220-1
17	23	12	1.3	17.000	16.989	—	—	22.993	22.972	7 960	10 900	25 000	—
17	24	15	1.3	—	—	—	—	—	—	9 660	12 700	25 000	IRT 1215-2
17	24	20	1.3	—	—	—	—	—	—	13 900	20 400	25 000	IRT 1220-2
17	24	25	1.3	17.000	16.989	24.012	23.991	—	—	17 900	28 100	25 000	IRT 1225-2
17	24	15	—	—	—	—	—	—	—	16 600	26 000	9 000	IRT 1215-2
17	24	25	—	—	—	—	—	—	—	27 200	49 000	9 000	IRT 1225-2
18	24	12	1.3	—	—	—	—	—	—	8 230	11 500	20 000	IRT 1512
18	24	16	1.3	18.000	17.989	—	—	23.993	23.972	10 400	15 600	20 000	IRT 1516
18	25	13	1.3	—	—	—	—	—	—	9 100	12 000	20 000	IRT 1513
18	25	15	1.3	—	—	—	—	—	—	10 100	13 600	20 000	IRT 1515
18	25	17	1.3	—	—	—	—	—	—	11 900	16 900	20 000	IRT 1517
18	25	19	1.3	18.000	17.989	25.012	24.991	—	—	13 700	20 200	20 000	IRT 1519
18	25	20	1.3	—	—	—	—	—	—	14 500	21 800	20 000	IRT 1520
18	25	25	1.3	—	—	—	—	—	—	18 600	30 000	20 000	IRT 1525
19	27	16	1.3	—	—	—	—	—	—	12 200	15 700	20 000	IRT 1516-1
19	27	20	1.3	19.000	18.987	27.012	26.991	—	—	16 100	22 600	20 000	IRT 1520-1

SHELL TYPE NEEDLE ROLLER BEARINGS



Shaft dia. 20 – 21mm

Shaft dia. mm	Identification number									
	Standard	Mass (Ref.) g	Closed end	Mass (Ref.) g	Standard	Mass (Ref.) g	Closed end	Mass (Ref.) g	Grease retained	Mass (Ref.) g
20	—	—	—	—	TLA 2012 Z	13.2	TLAM 2012	15.2	—	—
	—	—	—	—	TLA 2016 Z	17.8	TLAM 2016	19.9	—	—
	—	—	—	—	TLA 2020 Z	22	TLAM 2020	24	—	—
	—	—	—	—	TLA 2030 Z	33	TLAM 2030	35	—	—
	TA 2015 Z	20	TAM 2015	22.5	—	—	—	—	—	—
	TA 2020 Z	26.5	TAM 2020	29	—	—	—	—	—	—
	TA 2025 Z	33	TAM 2025	35.5	—	—	—	—	—	—
	TA 2030 Z	39.5	TAM 2030	42	—	—	—	—	—	—
	—	—	—	—	—	—	—	—	YT 2015	23.5
	—	—	—	—	—	—	—	—	YT 2025	41
TA 202820 Z	30	TAM 202820	32.5	—	—	—	—	—	—	
—	—	—	—	—	—	—	—	YT 202820	37.5	
21	TA 2116 Z	25	TAM 2116	28	—	—	—	—	—	—
	TA 2120 Z	31.5	TAM 2120	34.5	—	—	—	—	—	—
	—	—	—	—	—	—	—	—	YT 2116	31
	—	—	—	—	—	—	—	—	YT 2120	39

Note⁽¹⁾ Allowable rotational speed applies to oil lubrication. For grease lubrication, a maximum of 60% of this value is allowable.
 Remark Shell Type Grease Retained Full Complement Needle Roller Bearings are provided with prepacked grease. Standard type and closed end type bearings are not provided with prepacked grease, so perform proper lubrication when using these types of bearings.

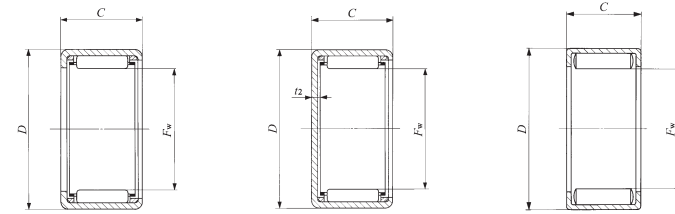

TA...Z TLA...Z

TAM TLAM

YT

Boundary dimensions mm				Standard mounting dimensions mm						Basic dynamic load rating C	Basic static load rating C ₀	Allowable rotational speed ⁽¹⁾ rpm	Assembled inner ring						
F _w	D	C	t ₂ Max.	Shaft dia. h6		Housing bore dia. J7 N7													
				Max.	Min.	Max.	Min.	Max.	Min.										
20	26	12	1.3	20.000	19.987	—	—	25.993	25.972	8 740	12 900	20 000	—						
20	26	16	1.3							11 100	17 500	20 000	IRT 1716						
20	26	20	1.3							14 500	24 700	20 000	IRT 1720						
20	26	30	1.3							22 300	42 900	20 000	IRT 1730						
20	27	15	1.3	20.000	19.987	27.012	26.991	—	—	10 400	14 600	20 000	IRT 1515-2						
20	27	20	1.3							15 000	23 400	20 000	IRT 1520-2						
20	27	25	1.3							19 200	32 200	20 000	IRT 1525-2						
20	27	30	1.3							23 100	41 000	20 000	IRT 1530-2						
20	27	15	—							18 400	30 900	7 500	IRT 1515-2						
20	27	25	—							30 000	58 300	7 500	IRT 1525-2						
20	28	20	1.3							20.000	19.987	28.012	27.991	—	—	16 900	24 300	20 000	IRT 1520-2
20	28	20	—													26 800	44 600	7 500	IRT 1520-2
21	29	16	1.3	21.000	20.987	29.012	28.991	—	—	13 300	18 100	19 000	IRT 1716-1						
21	29	20	1.3							17 600	25 900	19 000	IRT 1720-1						
21	29	16	—							22 100	35 200	7 000	IRT 1716-1						
21	29	20	—							27 500	46 800	7 000	IRT 1720-1						

1N=0.102kgf=0.2248lbs.
 1mm=0.03937inch

SHELL TYPE NEEDLE ROLLER BEARINGS



Shaft dia. 22 – 24mm

Shaft dia. mm	Identification number									
	Standard	Mass (Ref.) g	Closed end	Mass (Ref.) g	Standard	Mass (Ref.) g	Closed end	Mass (Ref.) g	Grease retained	Mass (Ref.) g
22	—	—	—	—	TLA 2212 Z	15.6	TLAM 2212	18.1	—	—
	—	—	—	—	TLA 2216 Z	21.5	TLAM 2216	24	—	—
	—	—	—	—	TLA 2220 Z	26.5	TLAM 2220	29	—	—
	TA 2210 Z	15	TAM 2210	18.1	—	—	—	—	—	—
	TA 2215 Z	21.5	TAM 2215	24.5	—	—	—	—	—	—
	TA 2220 Z	29	TAM 2220	32	—	—	—	—	—	—
	TA 2225 Z	35.5	TAM 2225	38.5	—	—	—	—	—	—
	TA 2230 Z	42.5	TAM 2230	45.5	—	—	—	—	—	—
	TA 223016 Z	26	TAM 223016	29	—	—	—	—	—	—
	TA 223020 Z	32.5	TAM 223020	35.5	—	—	—	—	—	—
—	—	—	—	—	—	—	—	YT 223016	32	
—	—	—	—	—	—	—	—	YT 223020	40.5	
24	TA 2420 Z	31	TAM 2420	35	—	—	—	—	—	—
	TA 2428 Z	43.5	TAM 2428	47	—	—	—	—	—	—
	—	—	—	—	—	—	—	—	YT 2428	54
	TA 243216 Z	28	TAM 243216	32	—	—	—	—	—	—
	TA 243220 Z	35.5	TAM 243220	39	—	—	—	—	—	—
	—	—	—	—	—	—	—	—	YT 243216	34.5
—	—	—	—	—	—	—	—	YT 243220	43.5	

Note⁽¹⁾ Allowable rotational speed applies to oil lubrication. For grease lubrication, a maximum of 60% of this value is allowable.
 Remark Shell Type Grease Retained Full Complement Needle Roller Bearings are provided with prepacked grease. Standard type and closed end type bearings are not provided with prepacked grease, so perform proper lubrication when using these types of bearings.

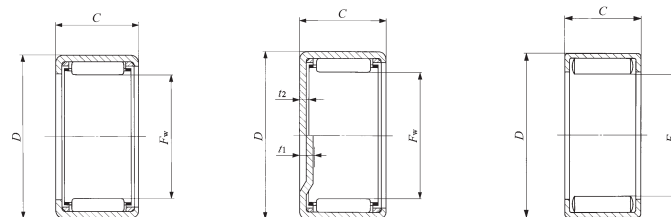

TA...Z TLA...Z

TAM TLAM
 $t_1 (F_w \geq 24)$
 $t_2 (F_w \leq 22)$

YT

F_w	Boundary dimensions mm			Standard mounting dimensions mm						Basic dynamic load rating C	Basic static load rating C_0	Allowable rotational speed ⁽¹⁾ rpm	Assembled inner ring
	D	C	t_1, t_2 Max.	Shaft dia. h6		Housing bore dia. J7 N7							
	Max.	Min.	Max.	Min.	Max.	Min.	Max.	Min.					
22	28	12	1.3	22.000	21.987	—	—	27.993	27.972	9 230	14 300	18 000	—
22	28	16	1.3	22.000	21.987	—	—	27.993	27.972	11 700	19 300	18 000	IRT 1716-2
22	28	20	1.3	22.000	21.987	29.012	28.991	—	—	15 300	27 300	18 000	IRT 1720-2
22	29	10	1.3	22.000	21.987	29.012	28.991	—	—	6 650	8 500	18 000	IRT 1710-2
22	29	15	1.3	22.000	21.987	29.012	28.991	—	—	11 100	16 400	18 000	IRT 1715-2
22	29	20	1.3	22.000	21.987	29.012	28.991	—	—	16 000	26 300	18 000	IRT 1720-2
22	29	25	1.3	22.000	21.987	29.012	28.991	—	—	19 700	34 300	18 000	IRT 1725-2
22	29	30	1.3	22.000	21.987	29.012	28.991	—	—	23 800	43 700	18 000	IRT 1730-2
22	30	16	1.3	22.000	21.987	30.012	29.991	—	—	13 200	18 200	18 000	IRT 1716-2
22	30	20	1.3	22.000	21.987	30.012	29.991	—	—	17 500	26 100	18 000	IRT 1720-2
22	30	16	—	22.000	21.987	30.012	29.991	—	—	22 600	36 800	7 000	IRT 1716-2
22	30	20	—	22.000	21.987	30.012	29.991	—	—	28 200	48 900	7 000	IRT 1720-2
24	31	20	3.4	24.000	23.987	31.014	30.989	—	—	17 000	29 200	16 000	IRT 2020
24	31	28	3.4	24.000	23.987	31.014	30.989	—	—	24 500	46 700	16 000	IRT 2028
24	31	28	—	24.000	23.987	31.014	30.989	—	—	36 800	79 900	6 500	IRT 2028
24	32	16	3.4	24.000	23.987	32.014	31.989	—	—	14 200	20 500	16 000	IRT 2016
24	32	20	3.4	24.000	23.987	32.014	31.989	—	—	18 800	29 400	16 000	IRT 2020
24	32	16	—	24.000	23.987	32.014	31.989	—	—	23 700	40 100	6 500	IRT 2016
24	32	20	—	24.000	23.987	32.014	31.989	—	—	29 500	53 200	6 500	IRT 2020

1N=0.102kgf=0.2248lbs.
 1mm=0.03937inch

SHELL TYPE NEEDLE ROLLER BEARINGS



Shaft dia. 25 – 28mm

Shaft dia. mm	Identification number									
	Standard	Mass (Ref.) g	Closed end	Mass (Ref.) g	Standard	Mass (Ref.) g	Closed end	Mass (Ref.) g	Grease retained	Mass (Ref.) g
25	—	—	—	—	TLA 2512 Z	19.7	TLAM 2512	23.5	—	—
	—	—	—	—	TLA 2516 Z	26	TLAM 2516	29.5	—	—
	—	—	—	—	TLA 2520 Z	32	TLAM 2520	36	—	—
	—	—	—	—	TLA 2526 Z	41.5	TLAM 2526	45.5	—	—
	—	—	—	—	TLAW2538Z	58.5	TLAMW2538	62	—	—
	—	—	—	—	—	—	—	—	YTL 2526	51.5
	TA 2510 Z	19.1	TAM 2510	23	—	—	—	—	—	—
	TA 2515 Z	28.5	TAM 2515	32.5	—	—	—	—	—	—
	TA 2520 Z	36.5	TAM 2520	40.5	—	—	—	—	—	—
	TA 2525 Z	45.5	TAM 2525	49	—	—	—	—	—	—
	TA 2530 Z	54.5	TAM 2530	58.5	—	—	—	—	—	—
	—	—	—	—	—	—	—	—	YT 2510	22.5
	—	—	—	—	—	—	—	—	YT 2515	33
	—	—	—	—	—	—	—	—	YT 2520	45
—	—	—	—	—	—	—	—	YT 2525	57	
26	TA 2616 Z	30.5	TAM 2616	34.5	—	—	—	—	—	—
	TA 2620 Z	38	TAM 2620	42.5	—	—	—	—	—	—
	—	—	—	—	—	—	—	—	YT 2616	37
	—	—	—	—	—	—	—	—	YT 2620	46.5
28	—	—	—	—	TLA 2816 Z	28.5	TLAM 2816	33.5	—	—
	—	—	—	—	TLA 2820 Z	35.5	TLAM 2820	40.5	—	—
	TA 2820 Z	45	TAM 2820	50	—	—	—	—	—	—
	TA 2830 Z	67.5	TAM 2830	72.5	—	—	—	—	—	—
	—	—	—	—	—	—	—	—	YT 2820	56.5
	—	—	—	—	—	—	—	—	—	—

Note(1) Allowable rotational speed applies to oil lubrication. For grease lubrication, a maximum of 60% of this value is allowable.

Remarks1. "W" in the identification number indicates that rolling elements are arranged in double rows.

2. Shell Type Grease Retained Full Complement Needle Roller Bearings are provided with prepacked grease. Standard type and closed end type bearings are not provided with prepacked grease, so perform proper lubrication when using these types of bearings.

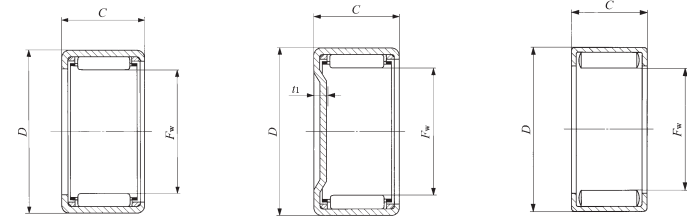

TA...Z TLA...Z

TAM TLAM

YT YTL

Boundary dimensions mm				Standard mounting dimensions mm						Basic dynamic load rating C	Basic static load rating C ₀	Allowable rotational speed ⁽¹⁾ rpm	Assembled inner ring
F _w	D	C	t ₁ Max.	Shaft dia. h6		Housing bore dia. J7 N7							
				Max.	Min.	Max.	Min.	Max.	Min.				
25	32	12	2.8	25.000	24.987	—	—	31.992	31.967	9 440	13 900	15 000	—
25	32	16	2.8							12 800	20 500	15 000	—
25	32	20	2.8							16 900	29 300	15 000	IRT 2026-1
25	32	26	2.8							22 600	42 500	15 000	IRT 2026-1
25	32	38	2.8	25.000	24.987	33.014	32.989	—	—	28 900	58 500	15 000	IRT 2038-1
25	32	26	—							35 000	75 800	6 000	IRT 2026-1
25	33	10	3.4							7 990	9 900	15 000	IRT 2010-1
25	33	15	3.4							13 400	19 300	15 000	IRT 2015-1
25	33	20	3.4	25.000	24.987	33.014	32.989	—	—	19 500	31 100	15 000	IRT 2020-1
25	33	25	3.4							24 100	40 800	15 000	IRT 2025-1
25	33	30	3.4							29 100	52 000	15 000	IRT 2030-1
25	33	10	—							15 500	23 600	6 000	IRT 2010-1
25	33	15	—	25.000	24.987	33.014	32.989	—	—	22 700	38 300	6 000	IRT 2015-1
25	33	20	—							30 200	55 400	6 000	IRT 2020-1
25	33	25	—							37 200	72 500	6 000	IRT 2025-1
26	34	16	3.4							15 200	22 900	15 000	IRT 2216
26	34	20	3.4	26.000	25.987	34.014	33.989	—	—	20 100	32 800	15 000	IRT 2220
26	34	16	—							24 700	43 300	6 000	IRT 2216
26	34	20	—							30 800	57 500	6 000	IRT 2220
28	35	16	2.8							28.000	27.987	—	—
28	35	20	2.8	18 300	33 600	13 000	IRT 2220-1						
28	37	20	3.4	28.000	27.987	37.014	36.989	—	—	21 200	32 300	13 000	IRT 2220-1
28	37	30	3.4							33 000	56 900	13 000	IRT 2230-1
28	37	20	—							34 700	61 700	5 500	IRT 2220-1

1N=0.102kgf=0.2248lbs.

1mm=0.03937inch

SHELL TYPE NEEDLE ROLLER BEARINGS



Shaft dia. 29 – 35mm

Shaft dia. mm	Identification number									
	Standard	Mass (Ref.) g	Closed end	Mass (Ref.) g	Standard	Mass (Ref.) g	Closed end	Mass (Ref.) g	Grease retained	Mass (Ref.) g
29	TA 2920 Z	47	TAM 2920	52	—	—	—	—	—	—
	TA 2930 Z	70	TAM 2930	75.5	—	—	—	—	YT 2920	58.5
30	—	—	—	—	TLA 3012 Z	23.5	TLAM 3012	29	—	—
	—	—	—	—	TLA 3016 Z	30.5	TLAM 3016	36	—	—
	—	—	—	—	TLA 3018 Z	34.5	TLAM 3018	40	—	—
	—	—	—	—	TLA 3020 Z	38	TLAM 3020	43.5	—	—
	—	—	—	—	TLA 3026 Z	49	TLAM 3026	54.5	—	—
	—	—	—	—	TLAW3038 Z	69	TLAMW3038	74.5	—	—
	TA 3013 Z	36.5	TAM 3013	42.5	—	—	—	—	—	—
	TA 3015 Z	42	TAM 3015	47.5	—	—	—	—	—	—
	TA 3020 Z	54.5	TAM 3020	60	—	—	—	—	—	—
	TA 3025 Z	68	TAM 3025	73.5	—	—	—	—	—	—
	TA 3030 Z	80	TAM 3030	85.5	—	—	—	—	—	—
32	TA 3220 Z	57.5	TAM 3220	63.5	—	—	—	—	—	—
	TA 3230 Z	86	TAM 3230	97.5	—	—	—	—	YT 3220	71.5
35	—	—	—	—	TLA 3512 Z	27	TLAM 3512	34.5	—	—
	—	—	—	—	TLA 3516 Z	35	TLAM 3516	42.5	—	—
	—	—	—	—	TLA 3520 Z	43.5	TLAM 3520	51	—	—
	TA 3512 Z	38.5	TAM 3512	46	—	—	—	—	—	—
	TA 3515 Z	48	TAM 3515	56	—	—	—	—	—	—
	TA 3520 Z	62.5	TAM 3520	70	—	—	—	—	—	—
	TA 3525 Z	78	TAM 3525	85.5	—	—	—	—	—	—
TA 3530 Z	97	TAM 3530	105	—	—	—	—	—	—	

Note(*) Allowable rotational speed applies to oil lubrication. For grease lubrication, a maximum of 60% of this value is allowable.

Remarks1. "W" in the identification number indicates that rolling elements are arranged in double rows.

2. Shell Type Grease Retained Full Complement Needle Roller Bearings are provided with prepacked grease. Standard type and closed end type bearings are not provided with prepacked grease, so perform proper lubrication when using these types of bearings.

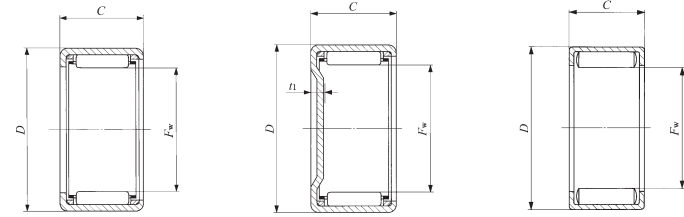

TA...Z TLA...Z

TAM TLAM

YT

F _w	Boundary dimensions mm			Standard mounting dimensions mm						Basic dynamic load rating C	Basic static load rating C ₀	Allowable rotational speed(*) rpm	Assembled inner ring
	D	C	f ₁ Max.	Shaft dia. h6		Housing bore dia. J7							
	Max.	Min.	Max.	Min.	Max.	Min.	Max.	Min.					
29	38	20	3.4	29.000	28.987	38.014	37.989	—	—	22 000	34 200	13 000	IRT 2520
29	38	30	3.4	29.000	28.987	38.014	37.989	—	—	34 200	60 300	13 000	IRT 2530
29	38	20	—	—	—	—	—	—	—	35 500	64 100	5 000	IRT 2520
30	37	12	2.8	30.000	29.987	—	—	36.992	36.967	10 400	16 600	12 000	—
30	37	16	2.8	—	—	—	—	—	—	14 100	24 500	12 000	—
30	37	18	2.8	—	—	—	—	—	—	16 400	29 800	12 000	—
30	37	20	2.8	—	—	—	—	—	—	18 600	35 100	12 000	IRT 2520-1
30	37	26	2.8	—	—	—	—	—	—	24 800	50 900	12 000	IRT 2526-1
30	37	38	2.8	—	—	—	—	—	—	31 900	70 200	12 000	IRT 2538-1
30	40	13	3.4	30.000	29.987	40.014	39.989	—	—	13 500	16 800	12 000	—
30	40	15	3.4	—	—	—	—	—	—	16 800	22 400	12 000	IRT 2515-1
30	40	20	3.4	30.000	29.987	40.014	39.989	—	—	24 500	36 300	12 000	IRT 2520-1
30	40	25	3.4	—	—	—	—	—	—	31 600	50 300	12 000	IRT 2525-1
30	40	30	3.4	—	—	—	—	—	—	36 700	60 700	12 000	IRT 2530-1
32	42	20	3.4	32.000	31.984	42.014	41.989	—	—	25 400	38 600	11 000	IRT 2820
32	42	30	3.4	—	—	—	—	—	—	39 500	68 400	11 000	IRT 2830
32	42	20	—	—	—	—	—	—	—	39 900	70 100	4 500	IRT 2820
35	42	12	2.8	35.000	34.984	—	—	41.992	41.967	11 600	20 000	10 000	IRT 3012
35	42	16	2.8	—	—	—	—	—	—	15 700	29 600	10 000	—
35	42	20	2.8	—	—	—	—	—	—	20 700	42 300	10 000	IRT 3020
35	45	12	3.4	35.000	34.984	45.014	44.989	—	—	14 800	19 900	10 000	IRT 3012
35	45	15	3.4	—	—	—	—	—	—	18 500	26 500	10 000	IRT 3015
35	45	20	3.4	35.000	34.984	45.014	44.989	—	—	27 000	43 100	10 000	IRT 3020
35	45	25	3.4	—	—	—	—	—	—	34 800	59 700	10 000	IRT 3025
35	45	30	3.4	—	—	—	—	—	—	40 600	72 600	10 000	IRT 3030

1N=0.102kgf=0.2248lbs.

1mm=0.03937inch

SHELL TYPE NEEDLE ROLLER BEARINGS



Shaft dia. 37 – 45mm

Shaft dia. mm	Identification number									
	Standard	Mass (Ref.) g	Closed end	Mass (Ref.) g	Standard	Mass (Ref.) g	Closed end	Mass (Ref.) g	Grease retained	Mass (Ref.) g
37	TA 3720 Z	64.5	TAM 3720	7	—	—	—	—	—	—
	TA 3730 Z	10	TAM 3730	110	—	—	—	—	—	—
	—	—	—	—	—	—	—	—	YT 3720	8
38	TA 3815 Z	5	TAM 3815	60	—	—	—	—	—	—
	TA 3820 Z	65.5	TAM 3820	74.5	—	—	—	—	—	—
	TA 3825 Z	82.5	TAM 3825	96	—	—	—	—	—	—
	TA 3830 Z	104	TAM 3830	114	—	—	—	—	—	—
	TAW 3845 Z	14	TAMW 3845	15	—	—	—	—	—	—
40	—	—	—	—	TLA 4012 Z	30	TLAM 4012	40	—	—
	—	—	—	—	TLA 4016 Z	39	TLAM 4016	49	—	—
	—	—	—	—	TLA 4020 Z	49	TLAM 4020	58.5	—	—
	TA 4015 Z	54	TAM 4015	6.5	—	—	—	—	—	—
	TA 4020 Z	6.5	TAM 4020	7	—	—	—	—	—	—
	TA 4025 Z	86.5	TAM 4025	102	—	—	—	—	—	—
	TA 4030 Z	110	TAM 4030	120	—	—	—	—	—	—
	TA 4040 Z	144	TAM 4040	154	—	—	—	—	—	—
	—	—	—	—	—	—	—	—	YT 4015	6.5
	—	—	—	—	—	—	—	—	YT 4025	10
45	—	—	—	—	TLA 4516 Z	43.5	TLAM 4516	56	—	—
	—	—	—	—	TLA 4520 Z	54.5	TLAM 4520	67	—	—
	TA 4520 Z	77	TAM 4520	90	—	—	—	—	—	—
	TA 4525 Z	102	TAM 4525	115	—	—	—	—	—	—
	TA 4530 Z	122	TAM 4530	135	—	—	—	—	—	—
	TA 4540 Z	16	TAM 4540	174	—	—	—	—	—	—
	—	—	—	—	—	—	—	—	YT 4520	96
—	—	—	—	—	—	—	—	YT 4525	122	

Note(*) Allowable rotational speed applies to oil lubrication. For grease lubrication, a maximum of 60% of this value is allowable.

Remarks1. "W" in the identification number indicates that rolling elements are arranged in double rows.

2. Shell Type Grease Retained Full Complement Needle Roller Bearings are provided with prepacked grease. Standard type and closed end type bearings are not provided with prepacked grease, so perform proper lubrication when using these types of bearings.

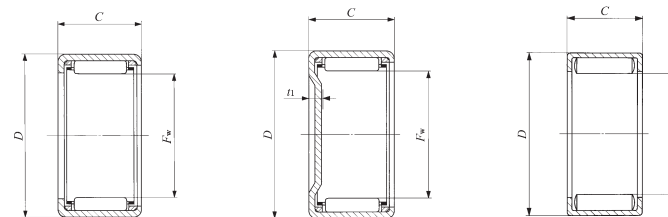

TA...Z TLA...Z

TAM TLAM

YT

F _w	Boundary dimensions mm			Standard mounting dimensions mm						Basic dynamic load rating C	Basic static load rating C ₀	Allowable rotational speed(*) rpm	Assembled inner ring	
	D	C	f ₁ Max.	Shaft dia. h6		Housing bore dia. J7		Max.	Min.					
	Max.	Min.	Max.	Min.	Max.	Min.	N	N						
7	47	20	.4								27 800	45 400	500	IRT 3220
37	47	30	3.4	7.000	6.984	47.014	46.98				41 800	76 700	9 500	IRT 3230
37	47	20	—								43 300	81 300	4 000	IRT 3220
38	48	15	3.4								19 000	28 000	9 000	IRT 3215-1
38	48	20	3.4								27 700	45 600	9 000	IRT 3220-1
38	48	25	3.4	38.000	37.984	48.014	47.98				35 600	63 100	9 000	IRT 3225-1
38	48	30	3.4								43 100	80 600	9 000	IRT 3230-1
38	48	45	3.4								55 700	112 000	9 000	IRT 3245-1
40	47	12	2.8								12 400	22 800	8 500	—
40	47	16	2.8	40.000	39.984	—	—	46.992	46.967		16 700	33 700	8 500	—
40	47	20	2.8								22 100	48 200	8 500	IRT 3520
40	50	15	3.4								19 500	29 400	8 500	IRT 3515
40	50	20	3.4								28 400	47 800	8 500	IRT 3520
40	50	25	3.4								36 600	66 200	8 500	IRT 3525
40	50	30	3.4	40.000	39.984	50.014	49.98	—	—		44 300	84 600	8 500	IRT 3530
40	50	40	3.4								56 700	116 000	8 500	IRT 3540
40	50	15	—								33 400	59 800	4 000	IRT 3515
40	50	25	—								55 300	114 000	4 000	IRT 3525
45	52	16	2.8								17 800	37 800	7 500	—
45	52	20	2.8	45.000	44.984	—	—	51.991	51.961		23 400	54 000	7 500	IRT 4020
45	55	20	3.4								30 600	54 600	7 500	IRT 4020
45	55	25	3.4								39 400	75 600	7 500	IRT 4025
45	55	30	3.4								47 700	96 600	7 500	IRT 4030
45	55	40	3.4	45.000	44.984	55.018	54.988	—	—		61 300	133 000	7 500	IRT 4040
45	55	20	—								47 800	98 200	3 500	IRT 4020
45	55	25	—								59 100	129 000	3 500	IRT 4025

1N=0.102kgf=0.2248lbs.

1mm=0.03 37inch

SHELL TYPE NEEDLE ROLLER BEARINGS

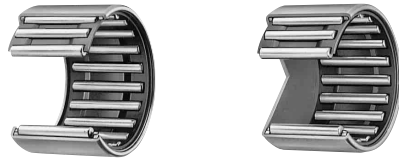

Shaft dia. 50 – 62mm

Shaft dia. mm	Identification number									
	Standard	Mass (Ref.) g	Closed end	Mass (Ref.) g	Standard	Mass (Ref.) g	Closed end	Mass (Ref.) g	Grease retained	Mass (Ref.) g
50	—	—	—	—	TLA 5020 Z	69	TLAM 5020	84.5	—	—
	—	—	—	—	TLA 5025 Z	86	TLAM 5025	107	—	—
	TA 5012 Z	62.5	TAM 5012	78	—	—	—	—	—	—
	TA 5015 Z	78	TAM 5015	98.5	—	—	—	—	—	—
	TA 5020 Z	107	TAM 5020	123	—	—	—	—	—	—
	TA 5025 Z	134	TAM 5025	150	—	—	—	—	—	—
	TA 5030 Z	161	TAM 5030	178	—	—	—	—	—	—
	TA 5040 Z	210	TAM 5040	230	—	—	—	—	—	—
TAW 5045 Z	230	TAMW 5045	245	—	—	—	—	—	—	
55	—	—	—	—	TLA 5520 Z	75	TLAM 5520	98.5	—	—
	—	—	—	—	TLA 5525 Z	98.5	TLAM 5525	118	—	—
	TA 5520 Z	116	TAM 5520	136	—	—	—	—	—	—
	TA 5525 Z	145	TAM 5525	165	—	—	—	—	—	—
	TA 5530 Z	175	TAM 5530	195	—	—	—	—	—	—
	TA 5540 Z	230	TAM 5540	250	—	—	—	—	—	—
	TAW 5545 Z	250	TAMW 5545	270	—	—	—	—	—	—
	TAW 5550 Z	280	TAMW 5550	300	—	—	—	—	—	—
60	TA 6025 Z	158	TAM 6025	182	—	—	—	—	—	—
	TA 6030 Z	191	TAM 6030	215	—	—	—	—	—	—
	TA 6040 Z	250	TAM 6040	275	—	—	—	—	—	—
	TAW 6045 Z	270	TAMW 6045	295	—	—	—	—	—	—
	TAW 6050 Z	305	TAMW 6050	330	—	—	—	—	—	—
62	TA 6212 Z	78	TAM 6212	107	—	—	—	—	—	—

Note(*) Allowable rotational speed applies to oil lubrication. For grease lubrication, a maximum of 60% of this value is allowable.
 Remarks1. "W" in the identification number indicates that rolling elements are arranged in double rows.
 2. Shell Type Grease Retained Full Complement Needle Roller Bearings are provided with prepacked grease. Standard type and closed end type bearings are not provided with prepacked grease, so perform proper lubrication when using these types of bearings.

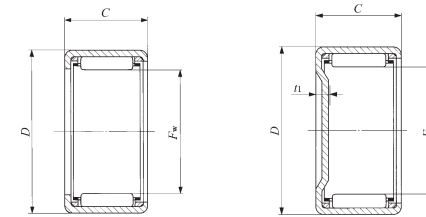

TA...Z TLA...Z

TAM TLAM

Boundary dimensions mm				Standard mounting dimensions mm						Basic dynamic load rating C	Basic static load rating C ₀	Allowable rotational speed ⁽¹⁾ rpm	Assembled inner ring						
F _w	D	C	t ₁ Max.	Shaft dia. h6		Housing bore dia. J7 N7													
				Max.	Min.	Max.	Min.	Max.	Min.	N	N								
50	58	20	2.8	50.000	49.984	—	—	57.991	57.961	28 800	64 100	6 500	IRT 4520						
50	58	25	2.8							36 900	88 400	6 500	IRT 4525						
50	62	12	3.4	50.000	49.984	62.018	61.988	—	—	17 700	24 000	6 500	IRT 4512						
50	62	15	3.4							25 800	39 000	6 500	IRT 4515						
50	62	20	3.4							38 000	64 000	6 500	IRT 4520						
50	62	25	3.4							49 100	89 000	6 500	IRT 4525						
50	62	30	3.4							59 500	114 000	6 500	IRT 4530						
50	62	40	3.4							76 500	157 000	6 500	IRT 4540						
50	62	45	3.4							76 700	158 000	6 500	IRT 4545						
55	63	20	2.8							55.000	54.981	—	—	62.991	62.961	29 800	69 400	5 500	IRT 5020-1
55	63	25	2.8	38 300	95 700	5 500	IRT 5025-1												
55	67	20	3.4	55.000	54.981	67.018	66.988	—	—	39 600	69 700	5 500	IRT 5020-1						
55	67	25	3.4							51 200	97 000	5 500	IRT 5025-1						
55	67	30	3.4							62 000	124 000	5 500	IRT 5030-1						
55	67	40	3.4							80 000	172 000	5 500	IRT 5040-1						
55	67	45	3.4							79 900	172 000	5 500	IRT 5045-1						
55	67	50	3.4							91 500	205 000	5 500	IRT 5050-1						
60	72	25	3.4							60.000	59.981	72.018	71.988	—	—	54 700	108 000	5 000	IRT 5025
60	72	30	3.4													66 300	139 000	5 000	IRT 5030
60	72	40	3.4	85 700	193 000	5 000	IRT 5040												
60	72	45	3.4	85 400	193 000	5 000	IRT 5045												
60	72	50	3.4	97 800	229 000	5 000	IRT 5050												
62	74	12	3.4	62.000	61.981	74.018	73.988	—	—							20 100	30 300	4 500	IRT 5212

1N=0.102kgf=0.2248lbs.
 1mm=0.03937inch

SHELL TYPE NEEDLE ROLLER BEARINGS

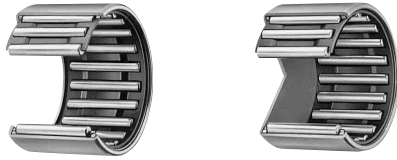

Shaft dia. 65 – 70mm

Shaft dia. mm	Identification number									
	Standard	Mass (Ref.) g	Closed end	Mass (Ref.) g	Standard	Mass (Ref.) g	Closed end	Mass (Ref.) g	Grease retained	Mass (Ref.) g
65	TA 6525 Z	169	TAM 6525	197	—	—	—	—	—	—
	TA 6530 Z	205	TAM 6530	2 0	—	—	—	—	—	—
	TAW 6545 Z	290	TAMW 6545	3 5	—	—	—	—	—	—
	TAW 6550 Z	330	TAMW 6550	355	—	—	—	—	—	—
70	TA 7025 Z	181	TAM 7025	2 5	—	—	—	—	—	—
	TA 7030 Z	220	TAM 7030	250	—	—	—	—	—	—
	TA 7040 Z	290	TAM 7040	3 0	—	—	—	—	—	—
	TAW 7050 Z	350	TAMW 7050	380	—	—	—	—	—	—

Note⁽¹⁾ Allowable rotational speed applies to oil lubrication. For grease lubrication, a maximum of 60% of this value is allowable.

Remarks1. "W" in the identification number indicates that rolling elements are arranged in double rows.

2. Shell Type Grease Retained Full Complement Needle Roller Bearings are provided with prepacked grease. Standard type and closed end type bearings are not provided with prepacked grease, so perform proper lubrication when using these types of bearings.

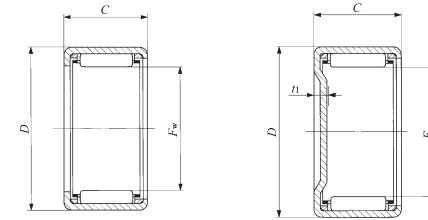

TA...Z

TAM

Boundary dimensions mm				Standard mounting dimensions mm						Basic dynamic load rating C	Basic static load rating C ₀	Allowable rotational speed ⁽¹⁾	Assembled inner ring
F _w	D	C	f ₁ Max.	Shaft dia. h6		Housing bore dia.				N	N	rpm	
				Max.	Min.	Max.	Min.	Max.	Min.				
5	77	5	.4	5.000	4.981	77.018	76.988			56 500	1 000	4 000	IRT 5525
65	77	30	3.4							68 500	149 000	4 000	IRT 5530
65	77	45	3.4							88 300	207 000	4 000	IRT 5545
65	77	50	3.4							101 000	246 000	4 000	IRT 5550
70	82	25	3.4	70.000	69.981	82.022	81.987			58 500	124 000	3 500	IRT 6025
70	82	30	3.4							70 900	159 000	3 500	IRT 6030
70	82	40	3.4							92 000	222 000	3 500	IRT 6040
70	82	50	3.4							105 000	262 000	3 500	IRT 6050

1N=0.10 kgf=0.2248lbs.
1mm=0.039 7inch

SHELL TYPE NEEDLE ROLLER BEARINGS

Inch Series



Shaft dia. 3.969 – 9.525mm

Shaft dia. mm (inch)	Identification number										
	Standard	Mass (Ref.) g	Closed end	Mass (Ref.) g	Standard	Mass (Ref.) g	Closed end	Mass (Ref.) g	Grease retained	Mass (Ref.) g	
3.969 ($\frac{5}{32}$)	—	—	—	—	—	—	—	—	YB 2.5 2.5	0.64	
	—	—	—	—	—	—	—	—	YB 2.5 4	0.96	
4.762 ($\frac{3}{16}$)	—	—	—	—	—	—	—	—	YB 34	1.6	
	—	—	—	—	—	—	—	—	—	—	
6.350 ($\frac{1}{4}$)	BA 44	2.1	—	—	—	—	—	—	—	—	
	BA 45 Z	2.5	BAM 45	2.7	—	—	—	—	—	—	
	BA 47 Z	3.5	BAM 47	3.7	—	—	—	—	—	—	
	—	—	—	—	—	—	—	—	YB 45	3.2	
7.938 ($\frac{5}{16}$)	—	—	—	—	—	—	—	—	YB 47	4.6	
	BA 55 Z	3	BAM 55	3.3	—	—	—	—	—	—	
	BA 56 Z	3.6	BAM 56	3.9	—	—	—	—	—	—	
	BA 57 Z	4.3	BAM 57	4.6	—	—	—	—	—	—	
	BA 59 Z	5.4	BAM 59	5.7	—	—	—	—	—	—	
	—	—	—	—	—	—	—	—	YB 55	3.8	
	—	—	—	—	BHA 57 Z	6.3	BHAM 57	6.6	—	—	—
	—	—	—	—	—	—	—	—	—	—	—
	9.525 ($\frac{3}{8}$)	BA 65 Z	3.5	BAM 65	3.9	—	—	—	—	—	—
		BA 66 Z	4.2	BAM 66	4.6	—	—	—	—	—	—
BA 68 Z		5.7	BAM 68	6.1	—	—	—	—	—	—	
BA 69 Z		6.3	BAM 69	6.7	—	—	—	—	—	—	
BA 610 Z		7	BAM 610	7.4	—	—	—	—	—	—	
—		—	—	—	—	—	—	—	YB 64	3.4	
—		—	—	—	—	—	—	—	YB 66	5.3	
—		—	—	—	—	—	—	—	YB 68	7.2	
—		—	—	—	—	—	—	—	YB 610	9.1	
—		—	—	—	BHA 68 Z	8.2	BHAM 68	8.6	—	—	—

Note(1) Allowable rotational speed applies to oil lubrication. For grease lubrication, a maximum of 60% of this value is allowable.
 Remark Shell Type Grease Retained Full Complement Needle Roller Bearings are provided with prepacked grease. Standard type and closed end type bearings are not provided with prepacked grease, so perform proper lubrication when using these types of bearings.

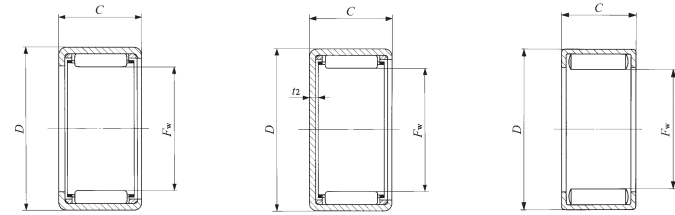

BA...Z BHA...Z BAM BHAM YB

Boundary dimensions mm(inch)				Standard mounting dimensions mm				Basic dynamic load rating C	Basic static load rating C ₀	Allowable rotational speed ⁽¹⁾ rpm	Assembled inner ring
F _w	D	C	t ₂ Max.	Shaft dia. h6		Housing bore dia. J7					
				Max.	Min.	Max.	Min.				
3.969 ($\frac{5}{32}$)	7.144 ($\frac{5}{16}$)	3.96(,156)	—	3.969	3.961	7.152	7.137	1 350	1 220	40 000	—
3.969 ($\frac{5}{32}$)	7.144 ($\frac{5}{16}$)	6.35(.250)	—	—	—	—	—	2 320	2 440	40 000	—
4.762 ($\frac{3}{16}$)	8.731 ($\frac{1}{2}$)	6.35(.250)	—	4.762	4.754	8.739	8.724	2 770	2 700	30 000	—
6.350 ($\frac{1}{4}$)	11.112 ($\frac{7}{16}$)	6.35(.250)	1	—	—	—	—	1 770	1 390	55 000	—
6.350 ($\frac{1}{4}$)	11.112 ($\frac{7}{16}$)	7.92(.312)	1	—	—	—	—	1 510	1 120	55 000	—
6.350 ($\frac{1}{4}$)	11.112 ($\frac{7}{16}$)	11.13(.438)	1	6.350	6.341	11.122	11.104	2 650	2 310	55 000	—
6.350 ($\frac{1}{4}$)	11.112 ($\frac{7}{16}$)	7.92(.312)	1	—	—	—	—	4 450	4 870	25 000	—
6.350 ($\frac{1}{4}$)	11.112 ($\frac{7}{16}$)	11.13(.438)	—	—	—	—	—	6 320	7 650	25 000	—
7.938 ($\frac{5}{16}$)	12.700 ($\frac{1}{2}$)	7.92(.312)	1	—	—	—	—	1 880	1 560	45 000	—
7.938 ($\frac{5}{16}$)	12.700 ($\frac{1}{2}$)	9.52(.375)	1	—	—	—	—	2 620	2 390	45 000	—
7.938 ($\frac{5}{16}$)	12.700 ($\frac{1}{2}$)	11.13(.438)	1	7.938	7.929	12.710	12.692	3 310	3 220	45 000	—
7.938 ($\frac{5}{16}$)	12.700 ($\frac{1}{2}$)	14.27(.562)	1	—	—	—	—	4 190	4 360	45 000	—
7.938 ($\frac{5}{16}$)	12.700 ($\frac{1}{2}$)	7.92(.312)	—	—	—	—	—	5 110	6 090	20 000	—
7.938 ($\frac{5}{16}$)	14.288 ($\frac{9}{16}$)	11.13(.438)	1.3	7.938	7.929	14.298	14.280	4 150	3 730	45 000	—
9.525 ($\frac{3}{8}$)	14.288 ($\frac{9}{16}$)	7.92(.312)	1	—	—	—	—	2 220	2 010	40 000	—
9.525 ($\frac{3}{8}$)	14.288 ($\frac{9}{16}$)	9.52(.375)	1	—	—	—	—	3 090	3 080	40 000	—
9.525 ($\frac{3}{8}$)	14.288 ($\frac{9}{16}$)	12.70(.500)	1	9.525	9.516	14.298	14.280	4 190	4 560	40 000	—
9.525 ($\frac{3}{8}$)	14.288 ($\frac{9}{16}$)	14.27(.562)	1	—	—	—	—	4 940	5 630	40 000	—
9.525 ($\frac{3}{8}$)	14.288 ($\frac{9}{16}$)	15.88(.625)	1	—	—	—	—	5 660	6 700	40 000	—
9.525 ($\frac{3}{8}$)	14.288 ($\frac{9}{16}$)	6.35(.250)	—	—	—	—	—	4 470	5 360	16 000	—
9.525 ($\frac{3}{8}$)	14.288 ($\frac{9}{16}$)	9.52(.375)	—	9.525	9.516	14.298	14.280	6 920	9 410	16 000	—
9.525 ($\frac{3}{8}$)	14.288 ($\frac{9}{16}$)	12.70(.500)	—	—	—	—	—	9 210	13 600	16 000	—
9.525 ($\frac{3}{8}$)	14.288 ($\frac{9}{16}$)	15.88(.625)	—	—	—	—	—	11 300	17 800	16 000	—
9.525 ($\frac{3}{8}$)	15.875 ($\frac{5}{8}$)	12.70(.500)	1.3	9.525	9.516	15.885	15.867	4 880	4 740	40 000	—

1N=0.102kgf=0.2248lbs.
1mm=0.03937inch

SHELL TYPE NEEDLE ROLLER BEARINGS

Inch Series



Shaft dia. 11.112 – 12.700mm

Shaft dia. mm (inch)	Identification number									
	Standard	Mass (Ref.) g	Closed end	Mass (Ref.) g	Standard	Mass (Ref.) g	Closed end	Mass (Ref.) g	Grease retained	Mass (Ref.) g
11.112 ($\frac{7}{16}$)	BA 76 Z	4.8	BAM 76	5.3	—	—	—	—	—	—
	BA 77 Z	.6	BAM 77	6.2	—	—	—	—	—	—
	BA 78 Z	6.4	BAM 78	7	—	—	—	—	—	—
	BA 710 Z	7.9	BAM 710	8.5	—	—	—	—	—	—
	—	—	—	—	—	—	—	—	YB 78	8.2
	—	—	—	—	BHA 78 Z	9.3	BHAM 78	10	—	—
12.700 ($\frac{1}{2}$)	BA 85 Z	4.4	BAM 85	5.2	—	—	—	—	—	—
	BA 86 Z	.3	BAM 86	6.1	—	—	—	—	—	—
	BA 87 Z	6.3	BAM 87	7	—	—	—	—	—	—
	BA 88 Z	7.2	BAM 88	7.9	—	—	—	—	—	—
	BA 810 Z	.9	BAM 810	9.6	—	—	—	—	—	—
	BA 812 Z	0.6	BAM 812	11.3	—	—	—	—	—	—
	—	—	—	—	—	—	—	—	YB 84	4.3
	—	—	—	—	—	—	—	—	YB 86	6.7
	—	—	—	—	—	—	—	—	YB 87	7.9
	—	—	—	—	—	—	—	—	YB 88	9.1
	—	—	—	—	—	—	—	—	YB 810	11.5
	—	—	—	—	—	—	—	—	YB 812	13.9
	—	—	—	—	BHA 87 Z	9.	BHAM 87	9.9	—	—
	—	—	—	—	BHA 88 Z	10.4	BHAM 88	11.3	—	—
	—	—	—	—	BHA 810 Z	12.	BHAM 810	13.3	—	—
	—	—	—	—	BHA 812 Z	15	BHAM 812	15.8	—	—
	—	—	—	—	—	—	—	—	YBH 810	16

Note⁽¹⁾ Allowable rotational speed applies to oil lubrication. For grease lubrication, a maximum of 60% of this value is allowable.
 Remark Shell Type Grease Retained Full Complement Needle Roller Bearings are provided with prepacked grease. Standard type and closed end type bearings are not provided with prepacked grease, so perform proper lubrication when using these types of bearings.

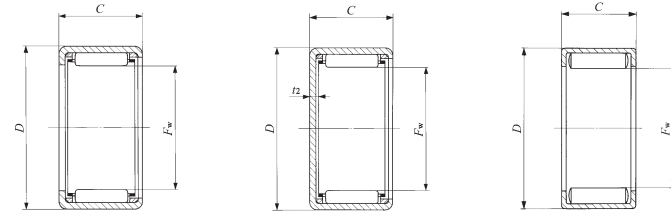

BA...Z BHA...Z

BAM BHAM

YB YBH

Boundary dimensions mm(inch)				Standard mounting dimensions mm				Basic dynamic load rating C	Basic static load rating C ₀	Allowable rotational speed ⁽¹⁾ rpm	Assembled inner ring
F _w	D	C	t ₂ Max.	Shaft dia. h6		Housing bore dia. J7					
				Max.	Min.	Max.	Min.				
.112 ($\frac{7}{16}$)	.87 ($\frac{7}{16}$)	9.52(.375)	1	—	—	—	—	3 290	3 470	35 000	—
11.112 ($\frac{7}{16}$)	15.875 ($\frac{5}{8}$)	11.13(.438)	1	.112	.10	.88	.867	4 150	4 680	35 000	—
11.112 ($\frac{7}{16}$)	15.875 ($\frac{5}{8}$)	12.70(.500)	1	—	—	—	—	4 460	5 130	35 000	—
11.112 ($\frac{7}{16}$)	15.875 ($\frac{5}{8}$)	15.88(.625)	1	—	—	—	—	6 020	7 550	35 000	—
11.112 ($\frac{7}{16}$)	15.875 ($\frac{5}{8}$)	12.70(.500)	—	—	—	—	—	10 100	15 900	14 000	—
11.112 ($\frac{7}{16}$)	17.462 ($\frac{11}{16}$)	12.70(.500)	1.3	11.112	11.10	17.472	17.454	5 680	5 970	35 000	—
11.112 ($\frac{7}{16}$)	17.462 ($\frac{11}{16}$)	12.70(.500)	—	—	—	—	—	12 500	15 800	14 000	—
12.700 ($\frac{1}{2}$)	17.462 ($\frac{11}{16}$)	7.92(.312)	1	—	—	—	—	2 490	2 510	30 000	—
12.700 ($\frac{1}{2}$)	17.462 ($\frac{11}{16}$)	9.52(.375)	1	12.700	12.689	17.472	17.454	3 470	3 850	30 000	—
12.700 ($\frac{1}{2}$)	17.462 ($\frac{11}{16}$)	11.13(.438)	1	—	—	—	—	4 380	5 190	30 000	—
12.700 ($\frac{1}{2}$)	17.462 ($\frac{11}{16}$)	12.70(.500)	1	—	—	—	—	4 710	5 700	30 000	IRB 58
12.700 ($\frac{1}{2}$)	17.462 ($\frac{11}{16}$)	15.88(.625)	1	—	—	—	—	6 350	8 380	30 000	—
12.700 ($\frac{1}{2}$)	17.462 ($\frac{11}{16}$)	19.05(.750)	1	—	—	—	—	7 840	11 000	30 000	—
12.700 ($\frac{1}{2}$)	17.462 ($\frac{11}{16}$)	6.35(.250)	—	—	—	—	—	5 260	7 150	12 000	—
12.700 ($\frac{1}{2}$)	17.462 ($\frac{11}{16}$)	9.52(.375)	—	12.700	12.689	17.472	17.454	8 150	12 600	12 000	—
12.700 ($\frac{1}{2}$)	17.462 ($\frac{11}{16}$)	11.13(.438)	—	—	—	—	—	9 530	15 300	12 000	—
12.700 ($\frac{1}{2}$)	17.462 ($\frac{11}{16}$)	12.70(.500)	—	—	—	—	—	10 800	18 100	12 000	IRB 58
12.700 ($\frac{1}{2}$)	17.462 ($\frac{11}{16}$)	15.88(.625)	—	—	—	—	—	13 400	23 700	12 000	—
12.700 ($\frac{1}{2}$)	17.462 ($\frac{11}{16}$)	19.05(.750)	—	—	—	—	—	15 800	29 300	12 000	—
12.700 ($\frac{1}{2}$)	19.050 ($\frac{3}{4}$)	11.13(.438)	1.3	—	—	—	—	5 670	6 120	30 000	—
12.700 ($\frac{1}{2}$)	19.050 ($\frac{3}{4}$)	12.70(.500)	1.3	12.700	12.689	19.062	19.041	6 040	6 650	30 000	IRB 58
12.700 ($\frac{1}{2}$)	19.050 ($\frac{3}{4}$)	15.88(.625)	1.3	—	—	—	—	8 830	10 900	30 000	—
12.700 ($\frac{1}{2}$)	19.050 ($\frac{3}{4}$)	19.05(.750)	1.3	—	—	—	—	11 100	14 500	30 000	—
12.700 ($\frac{1}{2}$)	19.050 ($\frac{3}{4}$)	15.88(.625)	—	—	—	—	—	16 300	23 500	12 000	—

1N=0.102kgf=0.2248lbs.
 1mm=0.03937inch

SHELL TYPE NEEDLE ROLLER BEARINGS

Inch Series



Shaft dia. 14.288 – 15.875mm

Shaft dia. mm (inch)	Identification number									
	Standard	Mass (Ref.) g	Closed end	Mass (Ref.) g	Standard	Mass (Ref.) g	Closed end	Mass (Ref.) g	Grease retained	Mass (Ref.) g
14.288 ($\frac{9}{16}$)	BA 95 Z	4.9	BAM 95	5.8	—	—	—	—	—	—
	BA 96 Z	5.9	BAM 96	6.8	—	—	—	—	—	—
	BA 97 Z	6.9	BAM 97	7.8	—	—	—	—	—	—
	BA 98 Z	7.9	BAM 98	8.9	—	—	—	—	—	—
	BA 910 Z	9.9	BAM 910	10.8	—	—	—	—	—	—
	BA 912 Z	11.7	BAM 912	12.6	—	—	—	—	—	—
	—	—	—	—	—	—	—	—	YB 98	10.1
	—	—	—	—	—	—	—	—	YB 910	12.7
	—	—	—	—	—	—	—	—	YB 912	15.4
	—	—	—	—	BHA 98 Z	11.4	BHAM 98	12.5	—	—
	—	—	—	—	BHA 910 Z	13.6	BHAM 910	14.7	—	—
	—	—	—	—	BHA 912 Z	16.3	BHAM 912	17.4	—	—
15.875 ($\frac{5}{8}$)	BA 105 Z	5.3	BAM 105	6.5	—	—	—	—	—	—
	BA 107 Z	7.6	BAM 107	8.7	—	—	—	—	—	—
	BA 108 Z	8.7	BAM 108	9.9	—	—	—	—	—	—
	BA 1010 Z	10.8	BAM 1010	12	—	—	—	—	—	—
	BA 1012 Z	12.9	BAM 1012	14	—	—	—	—	—	—
	BA 1014 Z	15.1	BAM 1014	16.2	—	—	—	—	—	—
	BA 1016 Z	17.3	BAM 1016	18.4	—	—	—	—	—	—
	—	—	—	—	—	—	—	—	YB 105	6.7
	—	—	—	—	—	—	—	—	YB 108	11
	—	—	—	—	—	—	—	—	YB 1012	16.9
	—	—	—	—	BHA 108 Z	12.6	BHAM 108	13.9	—	—
	—	—	—	—	BHA 1010 Z	14.9	BHAM 1010	16.2	—	—
—	—	—	—	BHA 1012 Z	18	BHAM 1012	19.3	—	—	
—	—	—	—	BHA 1016 Z	24	BHAM 1016	25	—	—	
—	—	—	—	—	—	—	—	YBH 108	15.3	

Note⁽¹⁾ Allowable rotational speed applies to oil lubrication. For grease lubrication, a maximum of 60% of this value is allowable.
 Remark Shell Type Grease Retained Full Complement Needle Roller Bearings are provided with prepacked grease. Standard type and closed end type bearings are not provided with prepacked grease, so perform proper lubrication when using these types of bearings.

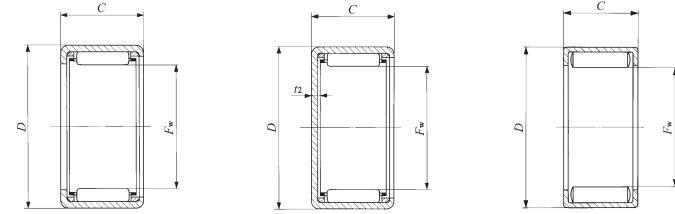

BA...Z BHA...Z

BAM BHAM

YB YBH

Boundary dimensions mm(inch)				Standard mounting dimensions mm				Basic dynamic load rating C	Basic static load rating C ₀	Allowable rotational speed ⁽¹⁾ rpm	Assembled inner ring
F _w	D	C	t ₂ Max.	Shaft dia. h6		Housing bore dia. J7					
				Max.	Min.	Max.	Min.	N	N		
14.288 ($\frac{9}{16}$)	19.050 ($\frac{3}{4}$)	7.92 (.312)	1.3					2 760	2 970	30 000	—
14.288 ($\frac{9}{16}$)	19.050 ($\frac{3}{4}$)	9.52 (.375)	1.3					3 850	4 560	30 000	—
14.288 ($\frac{9}{16}$)	19.050 ($\frac{3}{4}$)	11.13 (.438)	1.3					4 860	6 140	30 000	—
14.288 ($\frac{9}{16}$)	19.050 ($\frac{3}{4}$)	12.70 (.500)	1.3					5 220	6 740	30 000	IRB 68
14.288 ($\frac{9}{16}$)	19.050 ($\frac{3}{4}$)	15.88 (.625)	1.3	14.288	14.277	19.062	19.041	7 050	9 910	30 000	—
14.288 ($\frac{9}{16}$)	19.050 ($\frac{3}{4}$)	19.05 (.750)	1.3					8 690	13 000	30 000	IRB 612
14.288 ($\frac{9}{16}$)	19.050 ($\frac{3}{4}$)	12.70 (.500)	—					11 600	20 400	11 000	IRB 68
14.288 ($\frac{9}{16}$)	19.050 ($\frac{3}{4}$)	15.88 (.625)	—					14 300	26 700	11 000	—
14.288 ($\frac{9}{16}$)	19.050 ($\frac{3}{4}$)	19.05 (.750)	—					16 800	33 000	11 000	IRB 612
14.288 ($\frac{9}{16}$)	20.638 ($\frac{13}{16}$)	12.70 (.500)	1.3					6 380	7 330	30 000	IRB 68
14.288 ($\frac{9}{16}$)	20.638 ($\frac{13}{16}$)	15.88 (.625)	1.3	14.288	14.277	20.650	20.629	9 280	11 900	30 000	—
14.288 ($\frac{9}{16}$)	20.638 ($\frac{13}{16}$)	19.05 (.750)	1.3					11 600	15 900	30 000	IRB 612
15.875 ($\frac{5}{8}$)	20.638 ($\frac{13}{16}$)	7.92 (.312)	1.3					2 870	3 220	25 000	—
15.875 ($\frac{5}{8}$)	20.638 ($\frac{13}{16}$)	11.13 (.438)	1.3					5 040	6 660	25 000	—
15.875 ($\frac{5}{8}$)	20.638 ($\frac{13}{16}$)	12.70 (.500)	1.3					5 420	7 310	25 000	IRB 68-1
15.875 ($\frac{5}{8}$)	20.638 ($\frac{13}{16}$)	15.88 (.625)	1.3					7 320	10 700	25 000	—
15.875 ($\frac{5}{8}$)	20.638 ($\frac{13}{16}$)	19.05 (.750)	1.3	15.875	15.864	20.650	20.629	9 020	14 100	25 000	IRB 612-1
15.875 ($\frac{5}{8}$)	20.638 ($\frac{13}{16}$)	22.22 (.875)	1.3					10 700	17 500	25 000	IRB 714
15.875 ($\frac{5}{8}$)	20.638 ($\frac{13}{16}$)	25.40 (1.000)	1.3					12 300	20 800	25 000	IRB 716
15.875 ($\frac{5}{8}$)	20.638 ($\frac{13}{16}$)	7.92 (.312)	—					7 580	12 200	9 500	—
15.875 ($\frac{5}{8}$)	20.638 ($\frac{13}{16}$)	12.70 (.500)	—					12 300	22 700	9 500	IRB 68-1
15.875 ($\frac{5}{8}$)	20.638 ($\frac{13}{16}$)	19.05 (.750)	—					17 800	36 600	9 500	IRB 612-1
15.875 ($\frac{5}{8}$)	22.225 ($\frac{7}{8}$)	12.70 (.500)	1.3					6 680	8 020	25 000	IRB 68-1
15.875 ($\frac{5}{8}$)	22.225 ($\frac{7}{8}$)	15.88 (.625)	1.3					10 200	13 800	25 000	—
15.875 ($\frac{5}{8}$)	22.225 ($\frac{7}{8}$)	19.05 (.750)	1.3	15.875	15.864	22.237	22.216	12 700	18 500	25 000	IRB 612-1
15.875 ($\frac{5}{8}$)	22.225 ($\frac{7}{8}$)	25.40 (1.000)	1.3					17 400	27 600	25 000	IRB 716
15.875 ($\frac{5}{8}$)	22.225 ($\frac{7}{8}$)	12.70 (.500)	—					15 000	22 400	9 500	IRB 68-1

1N=0.102kgf=0.2248lbs.
 1mm=0.03937inch

SHELL TYPE NEEDLE ROLLER BEARINGS

Inch Series



Shaft dia. 17.462 – 19.050mm

Shaft dia. mm (inch)	Identification number									
	Standard	Mass (Ref.) g	Closed end	Mass (Ref.) g	Standard	Mass (Ref.) g	Closed end	Mass (Ref.) g	Grease retained	Mass (Ref.) g
17.462 ($\frac{11}{16}$)	BA 116 Z	7	BAM 116	8.4	—	—	—	—	—	—
	BA 118 Z	9.5	BAM 118	10.8	—	—	—	—	—	—
	BA 1110 Z	11.8	BAM 1110	13.2	—	—	—	—	—	—
	BA 1112 Z	14	BAM 1112	15.4	—	—	—	—	—	—
	—	—	—	—	—	—	—	—	YB 1112	18.3
	—	—	—	—	BHA 117 Z	11.9	BHAM 117	13.5	—	—
	—	—	—	—	BHA 118 Z	13.7	BHAM 118	15.3	—	—
	—	—	—	—	BHA 1110 Z	16	BHAM 1110	17.6	—	—
	—	—	—	—	BHA 1112 Z	19.3	BHAM 1112	21	—	—
	19.050 ($\frac{3}{4}$)	BA 126 Z	10	BAM 126	11.7	—	—	—	—	—
BA 128 Z		13.5	BAM 128	15.2	—	—	—	—	—	—
BA 1210 Z		17	BAM 1210	18.6	—	—	—	—	—	—
BA 1212 Z		20.5	BAM 1212	22	—	—	—	—	—	—
BA 1214 Z		23.5	BAM 1214	25	—	—	—	—	—	—
BA 1216 Z		27	BAM 1216	28.5	—	—	—	—	—	—
—		—	—	—	—	—	—	—	YB 124	8.5
—		—	—	—	—	—	—	—	YB 128	17.8
—		—	—	—	—	—	—	—	YB 1210	22.5
—		—	—	—	—	—	—	—	YB 1212	27
—		—	—	—	BHA 1212 Z	26.5	BHAM 1212	28.5	—	—
—		—	—	—	—	—	—	—	—	—
—		—	—	—	—	—	—	—	—	—
—		—	—	—	—	—	—	—	—	—

Note(1) Allowable rotational speed applies to oil lubrication. For grease lubrication, a maximum of 60% of this value is allowable.
Remark Shell Type Grease Retained Full Complement Needle Roller Bearings are provided with prepacked grease. Standard type and closed end type bearings are not provided with prepacked grease, so perform proper lubrication when using these types of bearings.

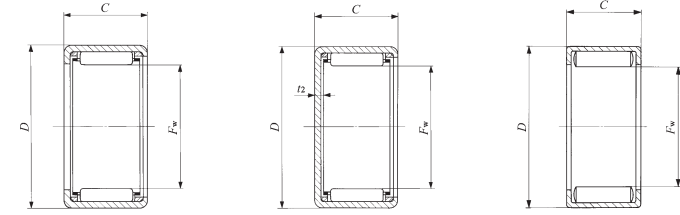

BA...Z BHA...Z BAM BHAM YB

Boundary dimensions mm(inch)				Standard mounting dimensions mm				Basic dynamic load rating C	Basic static load rating C ₀	Allowable rotational speed ⁽¹⁾ rpm	Assembled inner ring				
F _w	D	C	t ₂ Max.	Shaft dia. h6		Housing bore dia. J7									
				Max.	Min.	Max.	Min.								
17.462 ($\frac{11}{16}$)	22.225 ($\frac{7}{8}$)	9.52 (.375)	1.3	17.462	17.451	22.237	22.216	4 530	5 98	25 00	IRB 86				
17.462 ($\frac{11}{16}$)	22.225 ($\frac{7}{8}$)	12.70 (.500)	1.3					6 140	8 85	25 00	IRB 88				
17.462 ($\frac{11}{16}$)	22.225 ($\frac{7}{8}$)	15.88 (.625)	1.3					8 280	13 00	25 00	—				
17.462 ($\frac{11}{16}$)	22.225 ($\frac{7}{8}$)	19.05 (.750)	1.3					10 200	17 00	25 00	IRB 812				
17.462 ($\frac{11}{16}$)	22.225 ($\frac{7}{8}$)	19.05 (.750)	—					18 700	40 30	—	IRB 812				
17.462 ($\frac{11}{16}$)	23.812 ($\frac{15}{16}$)	11.13 (.438)	1.3					17.462	17.451	23.824	23.803	6 860	8 53	25 00	—
17.462 ($\frac{11}{16}$)	23.812 ($\frac{15}{16}$)	12.70 (.500)	1.3									7 320	9 27	25 00	IRB 88
17.462 ($\frac{11}{16}$)	23.812 ($\frac{15}{16}$)	15.88 (.625)	1.3									10 500	14 90	25 00	—
17.462 ($\frac{11}{16}$)	23.812 ($\frac{15}{16}$)	19.05 (.750)	1.3									13 200	19 90	25 00	IRB 812
19.050 ($\frac{3}{4}$)	25.400 (1)	9.52 (.375)	1.3									19.050	19.037	25.4	25.391
19.050 ($\frac{3}{4}$)	25.400 (1)	12.70 (.500)	1.3	6 910	8 78	20 00	IRB 88-1								
19.050 ($\frac{3}{4}$)	25.400 (1)	15.88 (.625)	1.3	9 500	13 20	20 00	IRB 810-1								
19.050 ($\frac{3}{4}$)	25.400 (1)	19.05 (.750)	1.3	11 900	17 70	20 00	IRB 812-1								
19.050 ($\frac{3}{4}$)	25.400 (1)	22.22 (.875)	1.3	14 200	22 20	20 00	IRB 814-1								
19.050 ($\frac{3}{4}$)	25.400 (1)	25.40(1.000)	1.3	16 300	26 50	20 00	IRB 816-1								
19.050 ($\frac{3}{4}$)	25.400 (1)	6.35 (.250)	—	19.050	19.037	25.4	25.391	7 820	10 20	8 00	—				
19.050 ($\frac{3}{4}$)	25.400 (1)	12.70 (.500)	—					16 600	26 90	8 00	IRB 88-1				
19.050 ($\frac{3}{4}$)	25.400 (1)	15.88 (.625)	—					20 500	35 30	8 00	IRB 810-1				
19.050 ($\frac{3}{4}$)	25.400 (1)	19.05 (.750)	—					24 100	43 40	8 00	IRB 812-1				
9.050 ($\frac{3}{8}$)	6.988 (1 $\frac{1}{8}$)	19.05 (.750)	1.3					9.050	9.037	7.0	6.979	6 6	60	00	IRB 812-1

1N=0.102kgf=0.2248lbs.
1mm=0.039 7inch

SHELL TYPE NEEDLE ROLLER BEARINGS

Inch Series



Shaft dia. 20.638 – 22.225mm

Shaft dia. mm (inch)	Identification number									
	Standard	Mass (Ref.) g	Closed end	Mass (Ref.) g	Standard	Mass (Ref.) g	Closed end	Mass (Ref.) g	Grease retained	Mass (Ref.) g
20.638 ($\frac{13}{16}$)	BA 136 Z	10.7	BAM 136	12.6	—	—	—	—	—	—
	BA 138 Z	14.5	BAM 138	16.4	—	—	—	—	—	—
	BA 1310 Z	18.2	BAM 1310	20	—	—	—	—	—	—
	BA 1312 Z	22	BAM 1312	23.5	—	—	—	—	—	—
	BA 1314 Z	25	BAM 1314	27	—	—	—	—	—	—
	BA 1316 Z	28.5	BAM 1316	30.5	—	—	—	—	—	—
	BA 1320 Z	35.5	BAM 1320	37.5	—	—	—	—	—	—
	—	—	—	—	—	—	—	—	YB 136	14.1
	—	—	—	—	—	—	—	—	YB 138	19.1
	—	—	—	—	BHA 138 Z	20	BHAM 138	22.5	—	—
	—	—	—	—	BHA 1310 Z	23.5	BHAM 1310	25.5	—	—
	—	—	—	—	BHA 1312 Z	28.5	BHAM 1312	30.5	—	—
	—	—	—	—	—	—	—	—	YBH 1310	30.5
	—	—	—	—	—	—	—	—	YBH 1312	37
22.225 ($\frac{7}{8}$)	BA 146 Z	11.5	BAM 146	13.8	—	—	—	—	—	—
	BA 148 Z	15.6	BAM 148	17.8	—	—	—	—	—	—
	BA 1412 Z	23.5	BAM 1412	26	—	—	—	—	—	—
	BA 1414 Z	27	BAM 1414	29.5	—	—	—	—	—	—
	BA 1416 Z	31	BAM 1416	33.5	—	—	—	—	—	—
	BA 1418 Z	34.5	BAM 1418	37	—	—	—	—	—	—
	BA 1422 Z	42.5	BAM 1422	44.5	—	—	—	—	—	—
	—	—	—	—	—	—	—	—	YB 148	20.5
	—	—	—	—	—	—	—	—	YB 1412	31
	—	—	—	—	—	—	—	—	YB 1416	41.5
	—	—	—	—	BHA 1410 Z	25	BHAM 1410	27.5	—	—
	—	—	—	—	BHA 1412 Z	30	BHAM 1412	32.5	—	—
	—	—	—	—	BHA 1416 Z	39.5	BHAM 1416	42	—	—
	—	—	—	—	—	—	—	—	YBH 1412	39

Note(1) Allowable rotational speed applies to oil lubrication. For grease lubrication, a maximum of 60% of this value is allowable.
 Remark Shell Type Grease Retained Full Complement Needle Roller Bearings are provided with prepacked grease. Standard type and closed end type bearings are not provided with prepacked grease, so perform proper lubrication when using these types of bearings.

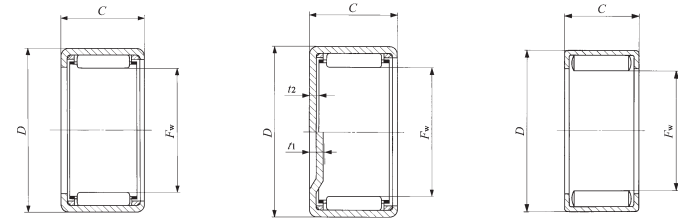

BA...Z BHA...Z

BAM BHAM
 $t_1 (F_w \geq 22.225)$
 $t_2 (F_w \leq 20.638)$

YB YBH

Boundary dimensions mm(inch)				Standard mounting dimensions mm				Basic dynamic load rating C	Basic static load rating C ₀	Allowable rotational speed ⁽¹⁾ rpm	Assembled inner ring
F _w	D	C	t ₁ t ₂ Max.	Shaft dia. h6		Housing bore dia. J7					
				Max.	Min.	Max.	Min.				
20.638($\frac{13}{16}$)	26.988(1 $\frac{1}{8}$)	9.52(.375)	1.3	20.638	20.625	27.000	26.979	5 230	6 300	19 000	—
20.638($\frac{13}{16}$)	26.988(1 $\frac{1}{8}$)	12.70(.500)	1.3	—	—	—	—	7 170	9 450	19 000	IRB 98
20.638($\frac{13}{16}$)	26.988(1 $\frac{1}{8}$)	15.88(.625)	1.3	—	—	—	—	9 870	14 200	19 000	IRB 910
20.638($\frac{13}{16}$)	26.988(1 $\frac{1}{8}$)	19.05(.750)	1.3	—	—	—	—	12 400	19 000	19 000	IRB 912
20.638($\frac{13}{16}$)	26.988(1 $\frac{1}{8}$)	22.22(.875)	1.3	—	—	—	—	14 700	23 800	19 000	IRB 914
20.638($\frac{13}{16}$)	26.988(1 $\frac{1}{8}$)	25.40(1.000)	1.3	—	—	—	—	16 900	28 500	19 000	IRB 916
20.638($\frac{13}{16}$)	26.988(1 $\frac{1}{8}$)	31.75(1.250)	1.3	—	—	—	—	21 200	38 100	19 000	IRB 920
20.638($\frac{13}{16}$)	26.988(1 $\frac{1}{8}$)	9.52(.375)	—	—	—	—	—	13 000	20 100	7 500	—
20.638($\frac{13}{16}$)	26.988(1 $\frac{1}{8}$)	12.70(.500)	—	—	—	—	—	17 400	29 200	7 500	IRB 98
20.638($\frac{13}{16}$)	28.575(1 $\frac{1}{4}$)	12.70(.500)	1.3	20.638	20.625	28.587	28.566	9 500	11 200	19 000	IRB 98
20.638($\frac{13}{16}$)	28.575(1 $\frac{1}{4}$)	15.88(.625)	1.3	—	—	—	—	13 800	18 200	19 000	IRB 910
20.638($\frac{13}{16}$)	28.575(1 $\frac{1}{4}$)	19.05(.750)	1.3	—	—	—	—	17 300	24 400	19 000	IRB 912
20.638($\frac{13}{16}$)	28.575(1 $\frac{1}{4}$)	15.88(.625)	—	—	—	—	—	22 900	36 300	7 500	IRB 910
20.638($\frac{13}{16}$)	28.575(1 $\frac{1}{4}$)	19.05(.750)	—	—	—	—	—	27 200	45 300	7 500	IRB 912
22.225($\frac{7}{8}$)	28.575(1 $\frac{1}{4}$)	9.52(.375)	2.8	—	—	—	—	5 430	6 740	18 000	IRB 106
22.225($\frac{7}{8}$)	28.575(1 $\frac{1}{4}$)	12.70(.500)	2.8	—	—	—	—	7 440	10 100	18 000	IRB 108
22.225($\frac{7}{8}$)	28.575(1 $\frac{1}{4}$)	19.05(.750)	2.8	—	—	—	—	12 800	20 400	18 000	IRB 1012
22.225($\frac{7}{8}$)	28.575(1 $\frac{1}{4}$)	22.22(.875)	2.8	—	—	—	—	15 300	25 500	18 000	IRB 1014
22.225($\frac{7}{8}$)	28.575(1 $\frac{1}{4}$)	25.40(1.000)	2.8	22.225	22.212	28.587	28.566	17 600	30 500	18 000	IRB 1016
22.225($\frac{7}{8}$)	28.575(1 $\frac{1}{4}$)	28.58(1.125)	2.8	—	—	—	—	19 800	35 600	18 000	—
22.225($\frac{7}{8}$)	28.575(1 $\frac{1}{4}$)	34.92(1.375)	2.8	—	—	—	—	24 100	45 700	18 000	IRB 1022
22.225($\frac{7}{8}$)	28.575(1 $\frac{1}{4}$)	12.70(.500)	—	—	—	—	—	18 100	31 400	7 000	IRB 108
22.225($\frac{7}{8}$)	28.575(1 $\frac{1}{4}$)	19.05(.750)	—	—	—	—	—	26 300	50 700	7 000	IRB 1012
22.225($\frac{7}{8}$)	28.575(1 $\frac{1}{4}$)	25.40(1.000)	—	—	—	—	—	33 800	70 200	7 000	IRB 1016
22.225($\frac{7}{8}$)	30.162(1 $\frac{1}{8}$)	15.88(.625)	3.4	22.225	22.212	30.176	30.151	14 300	19 500	18 000	—
22.225($\frac{7}{8}$)	30.162(1 $\frac{1}{8}$)	19.05(.750)	3.4	—	—	—	—	18 000	26 100	18 000	IRB 1012
22.225($\frac{7}{8}$)	30.162(1 $\frac{1}{8}$)	25.40(1.000)	3.4	—	—	—	—	23 600	36 900	18 000	IRB 1016
22.225($\frac{7}{8}$)	30.162(1 $\frac{1}{8}$)	19.05(.750)	—	—	—	—	—	28 200	49 000	7 000	IRB 1012

1N=0.102kgf=0.2248lbs.
 1mm=0.03937inch

SHELL TYPE NEEDLE ROLLER BEARINGS

Inch Series



Shaft dia. 23.812 – 26.988mm

Shaft dia. mm (inch)	Identification number									
	Standard	Mass (Ref.) g	Closed end	Mass (Ref.) g	Standard	Mass (Ref.) g	Closed end	Mass (Ref.) g	Grease retained	Mass (Ref.) g
23.812 (15/16)	BA 158 Z	16.5	BAM 158	19	—	—	—	—	—	—
	BA 1510 Z	20.5	BAM 1510	23	—	—	—	—	—	—
	BA 1516 Z	33	BAM 1516	35.5	—	—	—	—	—	—
25.400 (1)	BA 166 Z	13.1	BAM 166	16	—	—	—	—	—	—
	BA 167 Z	15.4	BAM 167	18.3	—	—	—	—	—	—
	BA 168 Z	17.7	BAM 168	20.5	—	—	—	—	—	—
	BA 1610 Z	22	BAM 1610	25	—	—	—	—	—	—
	BA 1612 Z	26.5	BAM 1612	29.5	—	—	—	—	—	—
	BA 1614 Z	31	BAM 1614	33.5	—	—	—	—	—	—
	BA 1616 Z	35.5	BAM 1616	38	—	—	—	—	—	—
	BA 1620 Z	44	BAM 1620	46.5	—	—	—	—	—	—
	—	—	—	—	—	—	—	—	YB 168	23
	—	—	—	—	—	—	—	—	YB 1612	34.5
	—	—	—	—	—	—	—	—	YB 1616	46.5
	—	—	—	—	BHA 168 Z	24	BHAM 168	27	—	—
	—	—	—	—	BHA 1610 Z	28	BHAM 1610	31	—	—
	—	—	—	—	BHA 1612 Z	33.5	BHAM 1612	37	—	—
	—	—	—	—	BHA 1614 Z	39.5	BHAM 1614	42.5	—	—
	—	—	—	—	BHA 1616 Z	45	BHAM 1616	48	—	—
	—	—	—	—	BHA 1620 Z	56.5	BHAM 1620	59.5	—	—
	—	—	—	—	BHA 1624 Z	67.5	BHAM 1624	71	—	—
	—	—	—	—	—	—	—	—	YBH 168	29
	—	—	—	—	—	—	—	—	YBH 1612	44.5
—	—	—	—	—	—	—	—	YBH 1616	59.5	
26.988 (1 1/16)	BA 1710 Z	23.5	BAM 1710	26.5	—	—	—	—	—	—
	BA 1716 Z	37	BAM 1716	40.5	—	—	—	—	—	—

Note(1) Allowable rotational speed applies to oil lubrication. For grease lubrication, a maximum of 60% of this value is allowable.
Remark Shell Type Grease Retained Full Complement Needle Roller Bearings are provided with prepacked grease. Standard type and closed end type bearings are not provided with prepacked grease, so perform proper lubrication when using these types of bearings.

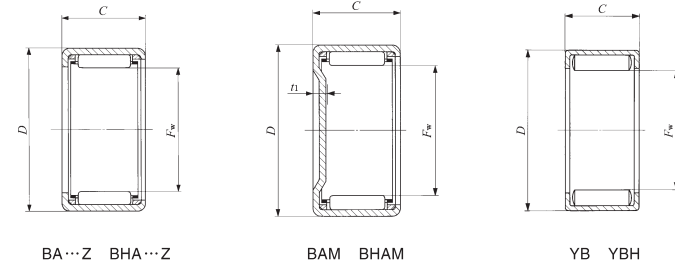

Boundary dimensions mm(inch)				Standard mounting dimensions mm				Basic dynamic load rating N	Basic static load rating N	Allowable rotational speed(1) rpm	Assembled inner ring
F _w	D	C	t ₁ Max.	Shaft dia. h6		Housing bore dia. J7					
				Max.	Min.	Max.	Min.				
23.812 (15/16)	30.162 (1 1/8)	12.70 (.500)	2.8	23.812	23.799	30.176	30.151	8 000	11 400	16 000	—
23.812 (15/16)	30.162 (1 1/8)	15.88 (.625)	2.8	—	—	—	—	11 000	17 100	16 000	IRB 1110
23.812 (15/16)	30.162 (1 1/8)	25.40 (1.000)	2.8	—	—	—	—	18 900	34 300	16 000	IRB 1116
25.400 (1)	31.750 (1 1/4)	9.52 (.375)	2.8	—	—	—	—	6 010	8 020	15 000	—
25.400 (1)	31.750 (1 1/4)	11.13 (.438)	2.8	—	—	—	—	7 720	11 100	15 000	—
25.400 (1)	31.750 (1 1/4)	12.70 (.500)	2.8	—	—	—	—	8 240	12 000	15 000	IRB 128
25.400 (1)	31.750 (1 1/4)	15.88 (.625)	2.8	—	—	—	—	11 300	18 100	15 000	—
25.400 (1)	31.750 (1 1/4)	19.05 (.750)	2.8	—	—	—	—	14 200	24 300	15 000	IRB 1212
25.400 (1)	31.750 (1 1/4)	22.22 (.875)	2.8	25.400	25.387	31.764	31.739	16 900	30 400	15 000	IRB 1214
25.400 (1)	31.750 (1 1/4)	25.40 (1.000)	2.8	—	—	—	—	19 400	36 300	15 000	IRB 1216
25.400 (1)	31.750 (1 1/4)	31.75 (1.250)	2.8	—	—	—	—	24 400	48 500	15 000	IRB 1220
25.400 (1)	31.750 (1 1/4)	12.70 (.500)	—	—	—	—	—	19 400	36 000	6 000	IRB 128
25.400 (1)	31.750 (1 1/4)	19.05 (.750)	—	—	—	—	—	28 200	58 000	6 000	IRB 1212
25.400 (1)	31.750 (1 1/4)	25.40 (1.000)	—	—	—	—	—	36 300	80 300	6 000	IRB 1216
25.400 (1)	33.338 (1 1/8)	12.70 (.500)	3.4	—	—	—	—	10 200	13 100	15 000	IRB 128
25.400 (1)	33.338 (1 1/8)	15.88 (.625)	3.4	—	—	—	—	15 300	22 100	15 000	—
25.400 (1)	33.338 (1 1/8)	19.05 (.750)	3.4	—	—	—	—	19 300	29 700	15 000	IRB 1212
25.400 (1)	33.338 (1 1/8)	22.22 (.875)	3.4	—	—	—	—	23 000	37 200	15 000	IRB 1214
25.400 (1)	33.338 (1 1/8)	25.40 (1.000)	3.4	25.400	25.387	33.352	33.327	26 400	44 500	15 000	IRB 1216
25.400 (1)	33.338 (1 1/8)	31.75 (1.250)	3.4	—	—	—	—	33 200	59 600	15 000	IRB 1220
25.400 (1)	33.338 (1 1/8)	38.10 (1.500)	3.4	—	—	—	—	39 400	74 400	15 000	—
25.400 (1)	33.338 (1 1/8)	12.70 (.500)	—	—	—	—	—	20 900	34 100	6 000	IRB 128
25.400 (1)	33.338 (1 1/8)	19.05 (.750)	—	—	—	—	—	30 700	56 100	6 000	IRB 1212
25.400 (1)	33.338 (1 1/8)	25.40 (1.000)	—	—	—	—	—	39 900	78 400	6 000	IRB 1216
26.988 (1 1/16)	33.338 (1 1/8)	15.88 (.625)	2.8	26.988	26.975	33.352	33.327	11 600	19 200	14 000	—
26.988 (1 1/16)	33.338 (1 1/8)	25.40 (1.000)	2.8	—	—	—	—	20 000	38 300	14 000	—

1N=0.102kgf=0.2248lbs.
1mm=0.03937inch

SHELL TYPE NEEDLE ROLLER BEARINGS

Inch Series



Shaft dia. 28.575 – 30.162mm

Shaft dia. mm (inch)	Identification number									
	Standard	Mass (Ref.) g	Closed end	Mass (Ref.) g	Standard	Mass (Ref.) g	Closed end	Mass (Ref.) g	Grease retained	Mass (Ref.) g
28.575 (1 1/8)	BA 186 Z	14.5	BAM 186	18.1	—	—	—	—	—	—
	BA 188 Z	19.5	BAM 188	23	—	—	—	—	—	—
	BA 1812 Z	29.5	BAM 1812	33	—	—	—	—	—	—
	BA 1816 Z	9	BAM 1816	42.5	—	—	—	—	—	—
	BA 1820 Z	4 .5	BAM 1820	52	—	—	—	—	—	—
	—	—	—	—	—	—	—	—	YB 188	25.5
	—	—	—	—	—	—	—	—	YB 1812	38.5
	—	—	—	—	—	—	—	—	YB 1816	51.5
	—	—	—	—	BHA 1812 Z	45	BHAM 1812	49	—	—
	—	—	—	—	BHA 1816 Z	60	BHAM 1816	64	—	—
—	—	—	—	BHA 1818 Z	67.5	BHAM 1818	71.5	—	—	
—	—	—	—	BHA 1820 Z	73.5	BHAM 1820	78	—	—	
30.162 (1 3/16)	BA 1910 Z	2.5	BAM 1910	37.5	—	—	—	—	—	—
	BA 1916 Z	52	BAM 1916	57	—	—	—	—	—	
	—	—	—	—	—	—	—	—	YB 1910	42.5

Note(1) Allowable rotational speed applies to oil lubrication. For grease lubrication, a maximum of 60% of this value is allowable.
Remark Shell Type Grease Retained Full Complement Needle Roller Bearings are provided with prepacked grease. Standard type and closed end type bearings are not provided with prepacked grease, so perform proper lubrication when using these types of bearings.

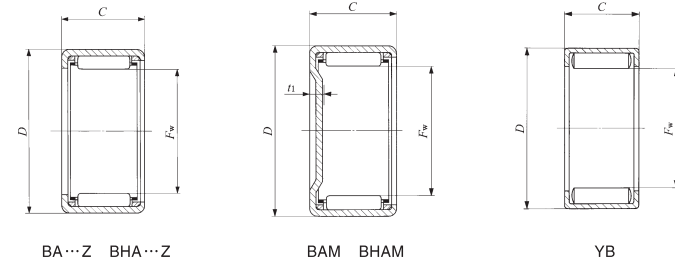

Boundary dimensions mm(inch)				Standard mounting dimensions mm				Basic dynamic load rating C	Basic static load rating C ₀	Allowable rotational speed ⁽¹⁾ rpm	Assembled inner ring				
F _w	D	C	t ₁ Max.	Shaft dia. h6		Housing bore dia. J7									
				Max.	Min.	Max.	Min.								
28.575(1 1/8)	34.925(1 3/8)	9.52(.375)	2.8	28.575	28.562	34.939	34.914	6 330	8 910	13 000	—				
28.575(1 1/8)	34.925(1 3/8)	12.70(.500)	2.8					15 000	26 900	13 000	IRB 148				
28.575(1 1/8)	34.925(1 3/8)	19.05(.750)	2.8					20 500	40 300	13 000	IRB 1412				
28.575(1 1/8)	34.925(1 3/8)	25.40(1.000)	2.8					25 700	53 900	13 000	IRB 1416				
28.575(1 1/8)	34.925(1 3/8)	31.75(1.250)	2.8					20 700	40 500	5 500	IRB 1420				
28.575(1 1/8)	34.925(1 3/8)	12.70(.500)	—					30 000	65 300	5 500	IRB 148				
28.575(1 1/8)	34.925(1 3/8)	19.05(.750)	—					38 700	90 400	5 500	IRB 1412				
28.575(1 1/8)	34.925(1 3/8)	25.40(1.000)	—					22 500	32 200	13 000	IRB 1416				
28.575(1 1/8)	38.100(1 1/2)	19.05(.750)	3.4					28.575	28.562	38.114	38.089	30 900	48 600	13 000	IRB 1412
28.575(1 1/8)	38.100(1 1/2)	25.40(1.000)	3.4									34 900	56 600	13 000	IRB 1416
28.575(1 1/8)	38.100(1 1/2)	28.58(1.125)	3.4	37 100	61 100	13 000	—								
28.575(1 1/8)	38.100(1 1/2)	31.75(1.250)	3.4	15 000	22 500	12 000	IRB 1420								
28.575(1 1/8)	38.100(1 1/2)	15.88(.625)	—	25 800	45 300	12 000	—								
0.162(1 3/16)	.100(1 3/16)	15.88(.625)	2.8	0.162	0.146	.114	3 .089	28 400	53 600	5 000	—				
30.162(1 3/16)	38.100(1 1/2)	25.40(1.000)	2.8					25 800	45 300	12 000	—				
30.162(1 3/16)	38.100(1 1/2)	15.88(.625)	—					28 400	53 600	5 000	—				

1N=0.102kgf=0.2248lbs.
1m =0.03937inch

SHELL TYPE NEEDLE ROLLER BEARINGS

Inch Series



Shaft dia. 31.750 – 33.338mm

Shaft dia. mm (inch)	Identification number									
	Standard	Mass (Ref.) g	Closed end	Mass (Ref.) g	Standard	Mass (Ref.) g	Closed end	Mass (Ref.) g	Grease retained	Mass (Ref.) g
31.750 (1 1/4)	BA 208 Z	21.5	BAM 208	26	—	—	—	—	—	—
	BA 2010 Z	27	BAM 2010	31.5	—	—	—	—	—	—
	BA 2012 Z	32.5	BAM 2012	37	—	—	—	—	—	—
	BA 2016 Z	43	BAM 2016	47.5	—	—	—	—	—	—
	BA 2020 Z	53.5	BAM 2020	58	—	—	—	—	—	—
	—	—	—	—	—	—	—	—	YB 2010	35
	—	—	—	—	—	—	—	—	YB 2012	42.5
	—	—	—	—	—	—	—	—	YB 2016	57
	—	—	—	—	—	—	—	—	YB 2018	64
	—	—	—	—	—	—	—	—	YB 2020	68
	—	—	—	—	BHA 208 Z	34.5	BHAM 208	40	—	—
	—	—	—	—	BHA 2012 Z	49.5	BHAM 2012	54.5	—	—
	—	—	—	—	BHA 2016 Z	66	BHAM 2016	71	—	—
	—	—	—	—	BHA 2020 Z	81.5	BHAM 2020	86.5	—	—
33.338 (1 5/16)	BA 218 Z	28.5	BAM 218	35	—	—	—	—	—	
	BA 2110 Z	35.5	BAM 2110	41.5	—	—	—	—	—	
	BA 2112 Z	43	BAM 2112	49	—	—	—	—	—	

Note(1) Allowable rotational speed applies to oil lubrication. For grease lubrication, a maximum of 60% of this value is allowable.
 Remark Shell Type Grease Retained Full Complement Needle Roller Bearings are provided with prepacked grease. Standard type and closed end type bearings are not provided with prepacked grease, so perform proper lubrication when using these types of bearings.

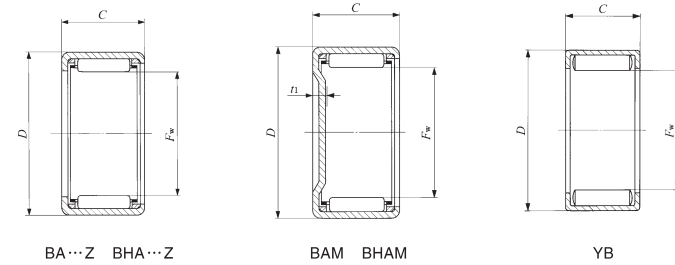

Boundary dimensions mm(inch)				Standard mounting dimensions mm				Basic dynamic load rating N	Basic static load rating N	Allowable rotational speed(1) rpm	Assembled inner ring				
F _w	D	C	t ₁ Max.	Shaft dia. h6		Housing bore dia. J7									
				Max.	Min.	Max.	Min.								
31.750 (1 1/4)	38.100 (1 1/2)	12.70 (.500)	2.8	31.750	31.734	38.114	38.089	9 100	14 700	12 000	IRB 168				
31.750 (1 1/4)	38.100 (1 1/2)	15.88 (.625)	2.8					12 500	22 200	12 000	IRB 1610				
31.750 (1 1/4)	38.100 (1 1/2)	19.05 (.750)	2.8					15 700	29 600	12 000	IRB 1612				
31.750 (1 1/4)	38.100 (1 1/2)	25.40 (1.000)	2.8					21 500	44 300	12 000	IRB 1616				
31.750 (1 1/4)	38.100 (1 1/2)	31.75 (1.250)	2.8					26 900	59 200	12 000	IRB 1620				
31.750 (1 1/4)	38.100 (1 1/2)	15.88 (.625)	—					31.750	31.734	38.114	38.089	27 000	59 000	4 500	IRB 1610
31.750 (1 1/4)	38.100 (1 1/2)	19.05 (.750)	—	31 800	72 500	4 500	IRB 1612								
31.750 (1 1/4)	38.100 (1 1/2)	25.40 (1.000)	—	40 900	100 000	4 500	IRB 1616								
31.750 (1 1/4)	38.100 (1 1/2)	28.58 (1.125)	—	45 300	114 000	4 500	—								
31.750 (1 1/4)	38.100 (1 1/2)	31.75 (1.250)	—	49 400	128 000	4 500	IRB 1620								
31.750 (1 1/4)	41.275 (1 5/8)	12.70 (.500)	3.4	31.750	31.734	41.289	41.264					13 700	17 600	12 000	IRB 168
31.750 (1 1/4)	41.275 (1 5/8)	19.05 (.750)	3.4					24 100	36 400	12 000	IRB 1612				
31.750 (1 1/4)	41.275 (1 5/8)	25.40 (1.000)	3.4					33 200	55 000	12 000	IRB 1616				
31.750 (1 1/4)	41.275 (1 5/8)	31.75 (1.250)	3.4					40 000	69 600	12 000	IRB 1620				
33.338 (1 5/16)	41.275 (1 5/8)	12.70 (.500)	2.8					33.338	33.322	41.289	41.264	11 100	15 800	11 000	IRB 168-1
33.338 (1 5/16)	41.275 (1 5/8)	15.88 (.625)	2.8									15 400	23 900	11 000	IRB 1610-1
33.338 (1 5/16)	41.275 (1 5/8)	19.05 (.750)	2.8	19 300	32 100	11 000	IRB 1612-1								

1N=0.102kgf=0.2248lbs.
 1mm=0.03937inch

SHELL TYPE NEEDLE ROLLER BEARINGS

Inch Series



Shaft dia. 34.925 – 38.100mm

Shaft dia. mm (inch)	Identification number										
	Standard	Mass (Ref.) g	Closed end	Mass (Ref.) g	Standard	Mass (Ref.) g	Closed end	Mass (Ref.) g	Grease retained	Mass (Ref.) g	
34.925 (1 3/8)	BA 228 Z	23.5	BAM 228	29	—	—	—	—	—	—	
	BA 2212 Z	35.5	BAM 2212	41	—	—	—	—	—	—	
	BA 2216 Z	47.5	BAM 2216	53	—	—	—	—	—	—	
	BA 2220 Z	59	BAM 2220	64	—	—	—	—	—	—	
	—	—	—	—	—	—	—	—	YB 228	30.5	
	—	—	—	—	—	—	—	—	YB 2212	46	
	—	—	—	—	—	—	—	—	YB 2220	77.5	
	—	—	—	—	BHA 228 Z	37	BHAM 228	43	—	—	
	—	—	—	—	BHA 2210 Z	44	BHAM 2210	50	—	—	
	—	—	—	—	BHA 2212 Z	53	BHAM 2212	59	—	—	
	—	—	—	—	BHA 2216 Z	71	BHAM 2216	77	—	—	
	—	—	—	—	BHA 2220 Z	87	BHAM 2220	98.5	—	—	
	38.100 (1 1/2)	BA 248 Z	38.5	BAM 248	47.5	—	—	—	—	—	—
		BA 2410 Z	48.5	BAM 2410	57.5	—	—	—	—	—	—
BA 2412 Z		58.5	BAM 2412	67.5	—	—	—	—	—	—	
BA 2414 Z		69	BAM 2414	78	—	—	—	—	—	—	
BA 2416 Z		79	BAM 2416	88	—	—	—	—	—	—	
BA 2420 Z		97.5	BAM 2420	106	—	—	—	—	—	—	
—		—	—	—	—	—	—	—	YB 246	38	
—		—	—	—	—	—	—	—	YB 248	51.5	
—		—	—	—	—	—	—	—	YB 2414	91	
—		—	—	—	—	—	—	—	YB 2416	105	
—		—	—	—	—	—	—	—	YB 2420	131	

Note(1) Allowable rotational speed applies to oil lubrication. For grease lubrication, a maximum of 60% of this value is allowable.
 Remark Shell Type Grease Retained Full Complement Needle Roller Bearings are provided with prepacked grease. Standard type and closed end type bearings are not provided with prepacked grease, so perform proper lubrication when using these types of bearings.

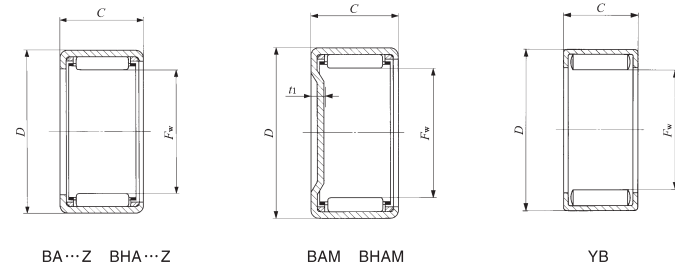

Boundary dimensions mm(inch)				Standard mounting dimensions mm				Basic dynamic load rating N	Basic static load rating N	Allowable rotational speed(1) rpm	Assembled inner ring
F _w	D	C	t ₁ Max.	Shaft dia. h6		Housing bore dia. J7					
			Max.	Max.	Min.	Max.	Min.				
34.925 (1 3/8)	41.275 (1 1/8)	12.70 (.500)	2.8	34.925	34.909	41.289	41.264	9 770	16 600	10 000	IRB 188
34.925 (1 3/8)	41.275 (1 3/8)	19.05 (.750)	2.8	—	—	—	—	16 900	33 500	10 000	IRB 1812
34.925 (1 3/8)	41.275 (1 3/8)	25.40 (1.000)	2.8	—	—	—	—	23 100	50 200	10 000	IRB 1816
34.925 (1 3/8)	41.275 (1 3/8)	31.75 (1.250)	2.8	—	—	—	—	28 900	67 100	10 000	IRB 1820
34.925 (1 3/8)	41.275 (1 3/8)	12.70 (.500)	—	—	—	—	—	23 000	49 500	4 500	IRB 188
34.925 (1 3/8)	41.275 (1 3/8)	19.05 (.750)	—	—	—	—	—	33 400	79 800	4 500	IRB 1812
34.925 (1 3/8)	41.275 (1 3/8)	31.75 (1.250)	—	—	—	—	—	52 000	141 000	4 500	IRB 1820
34.925 (1 3/8)	44.450 (1 3/4)	12.70 (.500)	3.4	34.925	34.909	44.464	44.439	14 100	18 800	10 000	IRB 188
34.925 (1 3/8)	44.450 (1 3/4)	15.88 (.625)	3.4	—	—	—	—	19 700	28 800	10 000	—
34.925 (1 3/8)	44.450 (1 3/4)	19.05 (.750)	3.4	—	—	—	—	24 800	38 800	10 000	IRB 1812
34.925 (1 3/8)	44.450 (1 3/4)	25.40 (1.000)	3.4	—	—	—	—	34 100	58 400	10 000	IRB 1816
34.925 (1 3/8)	44.450 (1 3/4)	31.75 (1.250)	3.4	—	—	—	—	41 200	74 200	10 000	IRB 1820
38.100 (1 1/2)	47.625 (1 7/8)	12.70 (.500)	2.8	38.100	38.084	47.639	47.614	12 900	17 900	9 000	—
38.100 (1 1/2)	47.625 (1 7/8)	15.88 (.625)	2.8	—	—	—	—	17 800	27 100	9 000	IRB 2010
38.100 (1 1/2)	47.625 (1 7/8)	19.05 (.750)	2.8	—	—	—	—	22 500	36 600	9 000	—
38.100 (1 1/2)	47.625 (1 7/8)	22.22 (.875)	2.8	—	—	—	—	26 700	45 600	9 000	IRB 2014
38.100 (1 1/2)	47.625 (1 7/8)	25.40 (1.000)	2.8	—	—	—	—	31 100	55 400	9 000	IRB 2016
38.100 (1 1/2)	47.625 (1 7/8)	31.75 (1.250)	2.8	—	—	—	—	39 000	74 200	9 000	IRB 2020
38.100 (1 1/2)	47.625 (1 7/8)	9.52 (.375)	—	—	—	—	—	21 000	34 100	4 000	—
38.100 (1 1/2)	47.625 (1 7/8)	12.70 (.500)	—	—	—	—	—	28 700	50 900	4 000	—
38.100 (1 1/2)	47.625 (1 7/8)	22.22 (.875)	—	38.100	38.084	47.639	47.614	48 900	101 000	4 000	IRB 2014
38.100 (1 1/2)	47.625 (1 7/8)	25.40 (1.000)	—	—	—	—	—	55 100	118 000	4 000	IRB 2016
38.100 (1 1/2)	47.625 (1 7/8)	31.75 (1.250)	—	—	—	—	—	66 800	151 000	4 000	IRB 2020

1N=0.102kgf=0.2248lbs.
1mm=0.03937inch

SHELL TYPE NEEDLE ROLLER BEARINGS

Inch Series



Shaft dia. 41.275 – 52.388mm

Shaft dia. mm (inch)	Identification number									
	Standard	Mass (Ref.) g	Closed end	Mass (Ref.) g	Standard	Mass (Ref.) g	Closed end	Mass (Ref.) g	Grease retained	Mass (Ref.) g
41.275 (1 5/8)	BA 268 Z	41	BAM 268	51.5	—	—	—	—	—	—
	BA 2610 Z	52	BAM 2610	62.5	—	—	—	—	—	—
	BA 2616 Z	85	BAM 2616	95.5	—	—	—	—	—	—
	BA 2620 Z	105	BAM 2620	115	—	—	—	—	YB 2610	69
44.450 (1 3/4)	BA 2812 Z	67.5	BAM 2812	79.5	—	—	—	—	—	—
	BA 2816 Z	91	BAM 2816	103	—	—	—	—	—	—
	BA 2820 Z	112	BAM 2820	125	—	—	—	—	—	—
	BA 2824 Z	136	BAM 2824	148	—	—	—	—	—	—
	—	—	—	—	BHA 2824 Z	195	BHAM 2824	210	—	—
47.625 (1 7/8)	BA 308 Z	47.5	BAM 308	61	—	—	—	—	—	—
	BA 3010 Z	60	BAM 3010	74	—	—	—	—	—	—
	BA 3012 Z	72.5	BAM 3012	86.5	—	—	—	—	—	—
	BA 3016 Z	97.5	BAM 3016	112	—	—	—	—	—	—
50.800 (2)	—	—	—	—	—	—	—	—	YB 3012	95
	BA 328 Z	50	BAM 328	66	—	—	—	—	—	—
	BA 3216 Z	104	BAM 3216	119	—	—	—	—	—	—
	BA 3220 Z	128	BAM 3220	144	—	—	—	—	—	—
	BA 3224 Z	155	BAM 3224	170	—	—	—	—	—	—
52.388 (2 1/16)	BAW3228Z	180	BAMW3228	196	—	—	—	—	—	—
	—	—	—	—	—	—	—	—	YB 3216	130
	—	—	—	—	BHA 3312 Z	104	BHAM 3312	122	—	—
	—	—	—	—	BHA 3316 Z	139	BHAM 3316	157	—	—
—	—	—	—	BHA 3324 Z	205	BHAM 3324	225	—	—	—

Note(1) Allowable rotational speed applies to oil lubrication. For grease lubrication, a maximum of 60% of this value is allowable.

Remarks1. "W" in the identification number indicates that rolling elements are arranged in double rows.

2. Shell Type Grease Retained Full Complement Needle Roller Bearings are provided with prepacked grease. Standard type and closed end type bearings are not provided with prepacked grease, so perform proper lubrication when using these types of bearings.

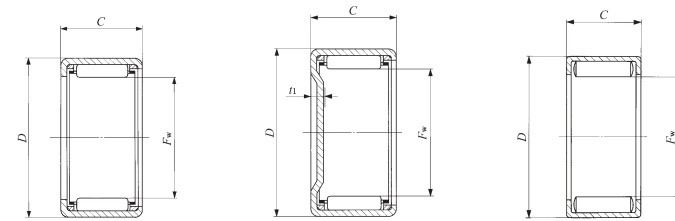

BA...Z BHA...Z

BAM BHAM

YB

Boundary dimensions mm(inch)				Standard mounting dimensions mm				Basic dynamic load rating C	Basic static load rating C ₀	Allowable rotational speed ⁽¹⁾ rpm	Assembled inner ring
F _w	D	C	t ₁ Max.	Shaft dia. h6		Housing bore dia. J7					
				Max.	Min.	Max.	Min.	N	N		
41.275 (1 5/8)	50.800 (2)	12.70 (.500)	2.8					13 700	19 800	8 000	—
41.275 (1 5/8)	50.800 (2)	15.88 (.625)	2.8					18 900	30 000	8 000	IRB 2210
41.275 (1 5/8)	50.800 (2)	25.40 (1.000)	2.8	41.275	41.259	50.818	50.788	33 000	61 400	8 000	—
41.275 (1 5/8)	50.800 (2)	31.75 (1.250)	2.8					41 400	82 100	8 000	IRB 2220
41.275 (1 5/8)	50.800 (2)	15.88 (.625)	—					37 000	71 700	3 500	IRB 2210
44.450 (1 3/4)	53.975 (2 1/8)	19.05 (.750)	2.8					25 200	44 500	7 500	IRB 2412
44.450 (1 3/4)	53.975 (2 1/8)	25.40 (1.000)	2.8					34 800	67 400	7 500	IRB 2416
44.450 (1 3/4)	53.975 (2 1/8)	31.75 (1.250)	2.8	44.450	44.434	53.993	53.963	43 600	90 200	7 500	—
44.450 (1 3/4)	53.975 (2 1/8)	38.10 (1.500)	2.8					52 000	113 000	7 500	IRB 2424
44.450 (1 3/4)	53.975 (2 1/8)	25.40 (1.000)	—					59 500	136 000	3 500	IRB 2416
44.450 (1 3/4)	57.150 (2 1/4)	38.10 (1.500)	3.4	44.450	44.434	57.168	57.138	72 200	135 000	7 500	IRB 2424
47.625 (1 7/8)	57.150 (2 1/4)	12.70 (.500)	2.8					14 700	22 800	7 000	IRB 248-1
47.625 (1 7/8)	57.150 (2 1/4)	15.88 (.625)	2.8					20 300	34 500	7 000	IRB 2410-1
47.625 (1 7/8)	57.150 (2 1/4)	19.05 (.750)	2.8	47.625	47.609	57.168	57.138	25 700	46 700	7 000	—
47.625 (1 7/8)	57.150 (2 1/4)	25.40 (1.000)	2.8					35 400	70 600	7 000	—
47.625 (1 7/8)	57.150 (2 1/4)	19.05 (.750)	—					47 800	105 000	3 000	—
50.800 (2)	60.325 (2 3/8)	12.70 (.500)	2.8					15 400	24 700	6 000	—
50.800 (2)	60.325 (2 3/8)	25.40 (1.000)	2.8					37 100	76 500	6 000	IRB 2616
50.800 (2)	60.325 (2 3/8)	31.75 (1.250)	2.8	50.800	50.781	60.343	60.313	46 600	102 000	6 000	IRB 2720
50.800 (2)	60.325 (2 3/8)	38.10 (1.500)	2.8					55 500	128 000	6 000	—
50.800 (2)	60.325 (2 3/8)	44.45 (1.750)	2.8					57 900	136 000	6 000	IRB 2628
50.800 (2)	60.325 (2 3/8)	25.40 (1.000)	—					64 100	156 000	2 500	IRB 2616
52.388 (2 1/16)	64.294 (2 5/8)	19.05 (.750)	3.4					36 400	62 100	6 000	—
52.388 (2 1/16)	64.294 (2 5/8)	25.40 (1.000)	3.4	52.388	52.369	64.312	64.282	50 600	94 700	6 000	—
52.388 (2 1/16)	64.294 (2 5/8)	38.10 (1.500)	3.4					73 900	154 000	6 000	—

1N=0.102kgf=0.2248lbs.
1mm=0.03937inch

SHELL TYPE NEEDLE ROLLER BEARINGS

Inch Series



Shaft dia. 53.975 – 69.850mm

Shaft dia. mm (inch)	Identification number									
	Standard	Mass (Ref.) g	Closed end	Mass (Ref.) g	Standard	Mass (Ref.) g	Closed end	Mass (Ref.) g	Grease retained	Mass (Ref.) g
53.975 (2 1/8)	BA 348 Z	53	BAM 348	70.5	—	—	—	—	—	—
	BA 3416 Z	109	BAM 3416	127	—	—	—	—	—	—
	BA 3424 Z	162	BAM 3424	180	—	—	—	—	—	—
57.150 (2 1/4)	BA 3612 Z	85.5	BAM 3612	105	—	—	—	—	—	—
	BA 3616 Z	115	BAM 3616	135	—	—	—	—	—	—
	BA 3620 Z	143	BAM 3620	163	—	—	—	—	—	—
	BA 3624 Z	172	BAM 3624	192	—	—	—	—	—	—
66.675 (2 5/8)	BA 4216 Z	133	BAM 4216	161	—	—	—	—	—	—
69.850 (2 3/4)	BA 4410 Z	85.5	BAM 4410	115	—	—	—	—	—	—
	BA 4412 Z	103	BAM 4412	133	—	—	—	—	—	—
	BA 4416 Z	139	BAM 4416	169	—	—	—	—	—	—
	BA 4420 Z	173	BAM 4420	205	—	—	—	—	—	—

Note(1) Allowable rotational speed applies to oil lubrication. For grease lubrication, a maximum of 60% of this value is allowable.
 Remark Shell Type Grease Retained Full Complement Needle Roller Bearings are provided with prepacked grease. Standard type and closed end type bearings are not provided with prepacked grease, so perform proper lubrication when using these types of bearings.

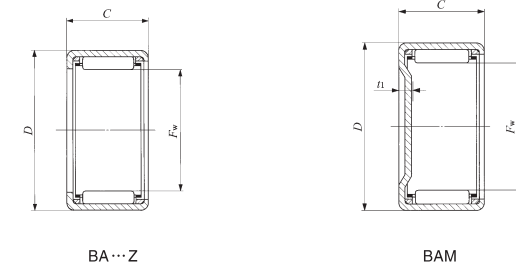

Boundary dimensions mm(inch)				Standard mounting dimensions mm				Basic dynamic load rating C	Basic static load rating C ₀	Allowable rotational speed ⁽¹⁾ rpm	Assembled inner ring
F _w	D	C	t ₁ Max.	Shaft dia. h6		Housing bore dia. J7					
				Max.	Min.	Max.	Min.				
53.975 (2 1/8)	63.500 (2 1/2)	12.70 (.500)	2.8	53.975	53.956	63.518	63.488	16 100	26 600	5 500	—
53.975 (2 1/8)	63.500 (2 1/2)	25.40 (1.000)	2.8					38 700	82 500	5 500	IRB 3016
53.975 (2 1/8)	63.500 (2 1/2)	38.10 (1.500)	2.8					57 900	138 000	5 500	IRB 3024
57.150 (2 1/4)	66.675 (2 5/8)	19.05 (.750)	2.8	57.150	57.131	66.693	66.663	28 500	56 700	5 000	—
57.150 (2 1/4)	66.675 (2 5/8)	25.40 (1.000)	2.8					39 300	85 700	5 000	—
57.150 (2 1/4)	66.675 (2 5/8)	31.75 (1.250)	2.8					49 400	115 000	5 000	—
57.150 (2 1/4)	66.675 (2 5/8)	38.10 (1.500)	2.8					58 800	144 000	5 000	—
66.675 (2 5/8)	76.200 (3)	25.40 (1.000)	2.8	66.675	66.656	76.218	76.188	42 000	97 900	4 000	IRB 3616
69.850 (2 3/4)	79.375 (3 1/8)	15.88 (.625)	2.8	69.850	69.831	79.393	79.363	25 000	50 800	3 500	—
69.850 (2 3/4)	79.375 (3 1/8)	19.05 (.750)	2.8					31 500	68 700	3 500	—
69.850 (2 3/4)	79.375 (3 1/8)	25.40 (1.000)	2.8					43 500	104 000	3 500	IRB 4016
69.850 (2 3/4)	79.375 (3 1/8)	31.75 (1.250)	2.8					54 600	139 000	3 500	IRB 4020

1N=0.102kgf=0.2248lbs.
1mm=0.03937inch

SHELL TYPE NEEDLE ROLLER BEARINGS

With seals

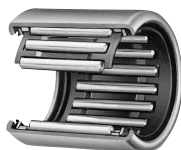

Shaft dia. 12 – 50mm

Shaft dia. mm	Identification number	Mass (Ref.) g	Boundary dimensions mm			Standard mounting dimension mm			
			F_w	D	C	Shaft dia. h6		Housing bore dia. N7	
						Max.	Min.	Max.	Min.
12	TLA 1216 UU	11.7	12	18	16	2.000	11.989	17.995	17.977
14	TLA 1416 UU	13.3	14	20	16	4.000	13.989	19.993	19.972
15	TLA 1516 UU	14	15	21	16	5.000	14.989	20.993	20.972
16	TLA 1616 UU	14.8	16	22	16	6.000	15.989	21.993	21.972
18	TLA 1816 UU	16.3	18	24	16	8.000	17.989	23.993	23.972
20	TLA 2016 UU	17.8	20	26	16	20.000	19.987	25.993	25.972
	TLA 2020 UU	22.5	20	26	20				
22	TLA 2216 UU	19.4	22	28	16	22.000	21.987	27.993	27.972
	TLA 2220 UU	25	22	28	20				
25	TLA 2516 UU	26	25	32	16	25.000	24.987	31.992	31.967
	TLA 2520 UU	33	25	32	20				
28	TLA 2820 UU	36.5	28	35	20	28.000	27.987	34.992	34.967
30	TLA 3016 UU	30.5	30	37	16	30.000	29.987	36.992	36.967
	TLA 3020 UU	39	30	37	20				
35	TLA 3516 UU	35	35	42	16	35.000	34.984	41.992	41.967
	TLA 3520 UU	45	35	42	20				
40	TLA 4016 UU	39.5	40	47	16	40.000	39.984	46.992	46.967
	TLA 4020 UU	50.5	40	47	20				
45	TLA 4520 UU	56	45	52	20	45.000	44.984	51.991	51.961
50	TLA 5026 UU	89	50	58	26	50.000	49.984	57.991	57.961

Note(1) Allowable rotational speed applies to grease lubrication.
Remark The type with seals is provided with prepacked grease.

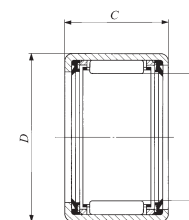

TLA...UU

Basic dynamic load rating C N	Basic static load rating C_0 N	Allowable rotational speed ⁽¹⁾ rpm
420	7 400	4 000
7 080	8 840	12 000
7 380	9 520	11 000
7 670	10 200	11 000
8 230	11 500	9 000
8 740	12 900	9 000
11 100	17 500	9 000
9 230	14 300	8 000
11 700	19 300	8 000
9 440	13 900	7 000
12 800	20 500	7 000
13 800	23 500	6 000
10 400	16 600	5 500
14 100	24 500	5 500
11 600	20 000	5 000
15 700	29 600	5 000
12 400	22 800	4 500
16 700	33 700	4 500
17 800	37 800	4 000
28 800	64 100	3 500

B

TA
TLA
BA
BHA

NEEDLE ROLLER CAGES FOR GENERAL USAGE



Structure and Features

TURNUP Needle Roller Cages for General Usage are bearings which display excellent rotational performance. Needle rollers with extremely small dimensional variations in diameter are incorporated and retained in their specially shaped cages with high rigidity and accuracy, which precisely guide the needle rollers.

When combined with shafts and housing bores that are heat treated and accurately ground as raceway surfaces, Needle Roller Cages for General Usage are particularly useful in small spaces. In addition, since they are lightweight and have high rigidity as well as a large lubricant holding capacity, they can withstand severe operating conditions such as high speed rotation and shock loads, and they are used in a wide range of applications.

Structures of Needle Roller Cages for General Usage

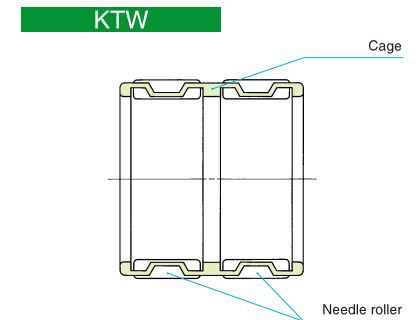
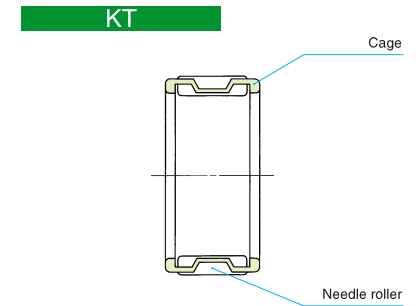

Types

Needle Roller Cages for General Usage are available in two types, with single row needle rollers and double row needle rollers.

For applications such as crank shafts where these bearings are difficult to install, it is also possible to make split type bearings.

If such bearings are required, please contact TURNUP.

For Needle Roller Cages for Engine Connecting Rods (KT...EG and KTV...EG), see page C17.

Identification Number

The identification number of Needle Roller Cages for General Usage consists of a model code, dimensions and any supplemental codes. The arrangement examples are shown below.

Examples of identification number

Example 1

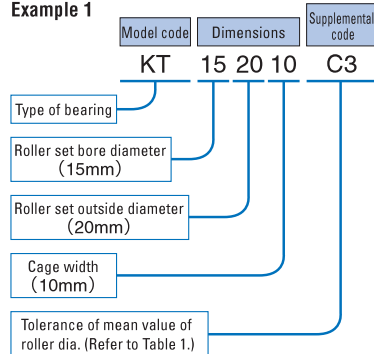

Example 2

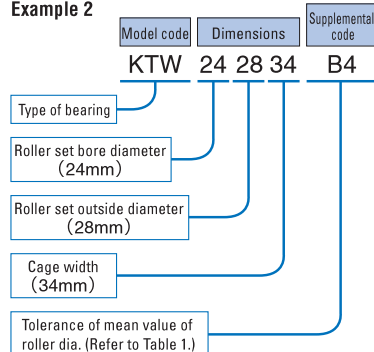

Accuracy

The diameter tolerances of needle rollers of Needle Roller Cages for General Usage are classified by classification symbols shown in Table 1. If a classification symbol is not indicated in an identification number, the classification symbol "C3" is applied.

When two or more bearings are used in tandem arrangement on the same shaft, it is necessary to select bearings of the same classification symbol to obtain an even load distribution.

The tolerance of the cage width B_c is $-0.20 \sim -0.55$ mm.

Table 1 Diameter tolerances of needle rollers unit: μ m

Classification symbol	Tolerance of mean value of needle roller diameter
C 3	0 ~ - 3
B 2	0 ~ - 2
B 4	- 2 ~ - 4
B 6	- 4 ~ - 6
B 8	- 6 ~ - 8
B10	- 8 ~ - 10

Fit

Radial clearances of Needle Roller Cages for General Usage are determined by the dimensional accuracy of the raceways and needle rollers. Table 2 shows the recommended fits for the operating conditions.

Table 2 Recommended fits of shaft to the housing bore diameter G6

Operating conditions	Shaft	
	$F_w \leq 68\text{mm}$	$F_w > 68\text{mm}$
When high operating accuracy is required.	j5	h5
When shock loads and oscillating motions are applied.		
For general use	h5	g5
When the temperature is high, or mounting errors are large.	g6	f6

Remark When setting the required radial clearance according to the operating conditions, the clearance can easily be obtained by selecting and matching the tolerances of needle rollers, shaft and housing bore. When variation of the clearance does not create any problems, h6 and G7 are used for shaft and housing bore, respectively.

Specifications of shaft and housing

For the raceways, a surface hardness of 58~64HRC and a surface roughness $0.2 \mu\text{m}R_a$ or less are desirable. However, when the operating conditions are not severe, a surface roughness $0.8 \mu\text{m}R_a$ or less can be used.

When the surface hardness is low, it is necessary to correct the load rating by the hardness factor specified on page A20.

Operating temperature range

For synthetic resin cages, "N" is added at the end of the identification number. The operating temperature range for Needle Roller Cages for General Usage is $-20^\circ\text{C} \sim +120^\circ\text{C}$. However, the maximum allowable temperature for synthetic resin cages is $+110^\circ\text{C}$, and when they are continuously operated, it is $+100^\circ\text{C}$.

Mounting

The dimensions related to mounting of Needle Roller Cages for General Usage are shown in Figs. 1 and 2. When mounting Needle Roller Cages for General Usage, they are axially positioned by using, for example, Cir-clips for shaft and housing bore (WR and AR on page L13) as shown in Figs. 3, 4 and 5.

For high rotational speed applications, a heat treated and ground spacer is positioned between the cage and the cir-clip as shown in Fig. 5 so that the cage does not make direct contact with the cir-clip. In this case, the cir-clip is normally mounted on the non-rotating side.

Fig. 3 shows a mounting example in the case of outer ring rotation, and Figs. 4 and 5 show examples in the case of inner ring rotation.

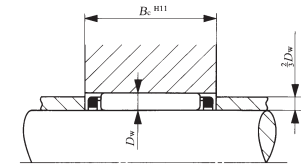

Fig.1

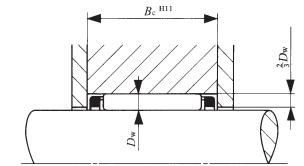

Fig.2

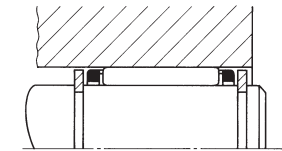

Fig.3

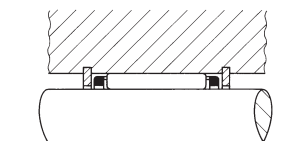

Fig.4

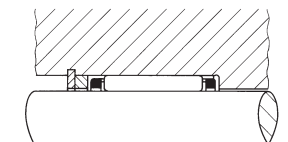

Fig.5

1N=0.102kgf=0.2248lbs.
1mm=0.03937inch

NEEDLE ROLLER CAGES FOR GENERAL USAGE



Shaft dia. 3 – 14mm

Shaft dia. mm	Identification number	Mass (Ref.) g	Boundary dimensions mm			Basic dynamic load rating C N	Basic static load rating C_0 N	Allowable rotational speed ⁽¹⁾ rpm
			F_w	E_w	B_c			
3	KT 367N	0.39	3	6	7	1 480	990	140 000
4	KT 477N	0.47	4	7	7	1 800	1 300	100 000
5	KT 587N	0.53	5	8	7	2 070	1 600	85 000
	KT 588N	0.66	5	8	8	2 420	1 950	85 000
6	KT 697N	0.63	6	9	7	2 310	1 900	75 000
	KT 698N	0.75	6	9	8	2 700	2 320	75 000
	KT 6910	1.45	6	9	10	3 010	2 660	75 000
	KT 61013	2.7	6	10	13	4 410	3 720	75 000
7	KT 7108N	0.86	7	10	8	2 960	2 690	65 000
	KT 71010	1.69	7	10	10	3 340	3 130	65 000
8	KT 8118N	0.96	8	11	8	3 190	3 060	60 000
	KT 81110	1.9	8	11	10	3 630	3 600	60 000
	KT 81113	2.5	8	11	13	4 500	4 750	60 000
	KT 8128	2.1	8	12	8	3 630	3 040	60 000
	KT 81211	3	8	12	11	4 630	4 170	60 000
9	KT 91210	2.1	9	12	10	3 900	4 070	55 000
	KT 91213	2.8	9	12	13	4 840	5 370	55 000
10	KT 10138	1.9	10	13	8	3 370	3 470	50 000
	KT 101310	2.3	10	13	10	4 160	4 550	50 000
	KT 101313	3	10	13	13	5 160	6 000	50 000
	KT 101410	3.2	10	14	10	4 900	4 680	50 000
	KT 101412	3.8	10	14	12	5 940	6 000	50 000
	KT 101413	4.2	10	14	13	6 100	6 200	50 000
KT 101415	4.8	10	14	15	7 080	7 520	50 000	
11	KT 111410	2.5	11	14	10	4 400	5 020	45 000

Note⁽¹⁾ Allowable rotational speed applies to oil lubrication. For grease lubrication, a maximum of 50% of this value is allowable.
Remark For synthetic resin cages, "N" is added at the end of the identification number.

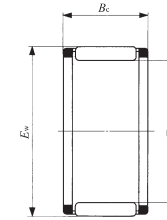

T

Shaft dia. mm	Identification number	Ma (Ref.) g	Boundary dimensions mm			Basic dynamic load rating C N	Basic static load rating C_0 N	Allowable rotational speed ⁽¹⁾ rpm
			w	E_w	B_c			
12	KT 12158	2.2	12	15	8	3 750	4 200	40 000
	KT 121510	2.7	12	15	10	4 620	5 490	40 000
	KT 121512	3.2	12	15	12	5 590	7 020	40 000
	KT 121513	3.6	12	15	13	5 730	7 250	40 000
	KT 121514	3.8	12	15	14	6 200	8 010	40 000
	KT 121610	4	12	16	10	5 650	5 890	40 000
	KT 121613	5.2	12	16	13	7 020	7 800	40 000
	KT 121618	7	12	16	18	9 790	11 900	40 000
	KT 121710	5.1	12	17	10	6 170	5 740	40 000
	KT 121812	7.8	12	18	12	9 030	8 460	40 000
KT 121820	13.2	12	18	20	13 700	14 400	40 000	
13	KT 131710	4.3	13	17	10	5 990	6 500	40 000
	KT 131815	8.2	13	18	15	9 660	10 400	40 000
	KT 131816	8.7	13	18	16	10 300	11 400	40 000
14	KT 14188	3.7	14	18	8	5 110	5 410	35 000
	KT 141810	4.6	14	18	10	6 320	7 110	35 000
	KT 141811	5.2	14	18	11	6 520	7 410	35 000
	KT 141813	6	14	18	13	7 860	9 410	35 000
	KT 141816	7.3	14	18	16	9 750	12 400	35 000
	KT 141910	5.9	14	19	10	7 130	7 180	35 000
	KT 141916	9.4	14	19	16	11 100	12 600	35 000
	KT 141918	10.5	14	19	18	12 400	14 700	35 000
	KT 142012	8.7	14	20	12	9 790	9 680	35 000
KT 142017	12.4	14	20	17	13 300	14 400	35 000	

1N=0.102kgf=0.2248lbs
1m =0.03937inch

NEEDLE ROLLER CAGES FOR GENERAL USAGE



Shaft dia. 15 – 18mm

Shaft dia. mm	Identification number	Mass (Ref.) g	Boundary dimensions mm			Basic dynamic load rating C N	Basic static load rating C_0 N	Allowable rotational speed ⁽¹⁾ rpm
			F_w	E_w	B_c			
15	KT 15199	4.4	15	19	9	6 120	6 950	35 000
	KT 151910	4.9	15	19	10	6 630	7 720	35 000
	KT 151911	5.5	15	19	11	6 850	8 040	35 000
	KT 151913	6.4	15	19	13	8 250	10 200	35 000
	KT 151917	8.2	15	19	17	10 900	14 600	35 000
	KT 151918	8.7	15	19	18	11 500	15 600	35 000
	KT 152010	6.3	15	20	10	7 580	7 920	35 000
	KT 152115	11.9	15	21	15	12 600	13 500	35 000
16	KT 162010	5.2	16	20	10	6 930	8 330	30 000
	KT 162013	6.8	16	20	13	8 620	11 000	30 000
	KT 162016	8.3	16	20	16	10 700	14 600	30 000
	KT 162017	8.7	16	20	17	11 400	15 700	30 000
	KT 162118	12	16	21	18	14 000	17 700	30 000
	KT 162120	13.6	16	21	20	14 700	18 900	30 000
	KT 162125	16.6	16	21	25	18 300	25 100	30 000
	KT 162212	9.7	16	22	12	10 500	10 900	30 000
	KT 162214	11.5	16	22	14	11 600	12 500	30 000
	KT 162217	13.8	16	22	17	14 200	16 100	30 000
	KT 162220	16.5	16	22	20	15 900	18 600	30 000
	KT 162420	23.5	16	24	20	18 500	19 000	30 000
	17	KT 172110	5.5	17	21	10	7 220	8 950
KT 172113		7.2	17	21	13	8 980	11 800	30 000
KT 172115		8.2	17	21	15	10 400	14 400	30 000
KT 172117		9.3	17	21	17	11 800	16 900	30 000
KT 172220		14	17	22	20	15 500	20 500	30 000
KT 172311		9.6	17	23	11	10 100	10 500	30 000
KT 172315		13.1	17	23	15	13 300	15 100	30 000
KT 172418		18.6	17	24	18	16 500	18 000	30 000

Note⁽¹⁾ Allowable rotational speed applies to oil lubrication. For grease lubrication, a maximum of 50% of this value is allowable.

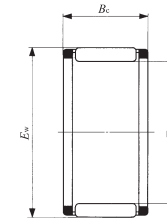

KT

Shaft dia. mm	Identification number	Mass (Ref.) g	Boundary dimensions mm			Basic dynamic load rating C N	Basic static load rating C_0 N	Allowable rotational speed ⁽¹⁾ rpm
			F_w	E_w	B_c			
18	KT 18228	4.7	18	22	8	6 060	7 270	30 000
	KT 182210	5.8	18	22	10	7 500	9 560	30 000
	KT 182213	7.6	18	22	13	9 330	12 700	30 000
	KT 182216	9.2	18	22	16	11 600	16 700	30 000
	KT 182412	11	18	24	12	11 800	13 100	30 000
	KT 182416	14.8	18	24	16	15 100	17 900	30 000
	KT 182417	15.7	18	24	17	16 000	19 400	30 000
	KT 182420	18.7	18	24	20	17 900	22 400	30 000
	KT 182517	18.8	18	25	17	16 700	18 600	30 000
	KT 182519	21	18	25	19	18 700	21 400	30 000
	KT 182522	24.5	18	25	22	20 600	24 200	30 000
	KT 182614	18.1	18	26	14	14 600	14 400	30 000
	KT 182620	26	18	26	20	20 000	21 600	30 000

1N=0.102kgf=0.2248lbs.
1mm=0.03937inch

NEEDLE ROLLER CAGES FOR GENERAL USAGE



Shaft dia. 20 – 24mm

Shaft dia. mm	Identification number	Mass (Ref.) g	Boundary dimensions mm			Basic dynamic load rating C N	Basic static load rating C_0 N	Allowable rotational speed ⁽¹⁾ rpm
			F_w	E_w	B_c			
20	KT 202410	6.3	20	24	10	7 710	10 200	25 000
	KT 202413	8.3	20	24	13	9 590	13 500	25 000
	KT 202417	10.6	20	24	17	12 600	19 300	25 000
	KTW 202422	14.6	20	24	22	13 700	21 300	25 000
	KT 202525	19.7	20	25	25	19 900	29 800	25 000
	KTW 202531.6	26.5	20	25	31.6	21 700	33 200	25 000
	KTW 202540	32.5	20	25	40	27 500	44 900	25 000
	KT 202611	11.1	20	26	11	11 200	12 500	25 000
	KT 202612	12	20	26	12	12 400	14 300	25 000
	KT 202614	14.2	20	26	14	13 700	16 400	25 000
	KT 202617	17	20	26	17	16 800	21 200	25 000
	KT 202620	20.5	20	26	20	18 700	24 400	25 000
	KT 202624	24	20	26	24	22 500	30 900	25 000
	KT 202627	26.5	20	26	27	26 000	37 300	25 000
	KT 202814	20	20	28	14	15 700	16 100	25 000
	KT 202820	29	20	28	20	21 500	24 200	25 000
KT 203225	49.5	20	32	25	30 800	30 500	25 000	
21	KT 212610	8.5	21	26	10	9 090	11 000	25 000
	KT 212611	9.6	21	26	11	9 390	11 500	25 000

Note⁽¹⁾ Allowable rotational speed applies to oil lubrication. For grease lubrication, a maximum of 50% of this value is allowable.

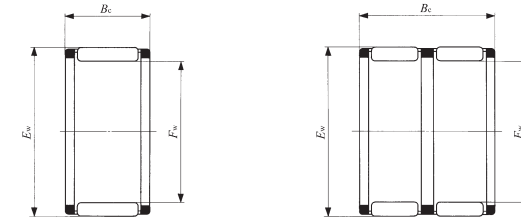

KT

KTW

Shaft dia. mm	Identification number	Mass (Ref.) g	Boundary dimensions mm			Basic dynamic load rating C N	Basic static load rating C_0 N	Allowable rotational speed ⁽¹⁾ rpm
			F_w	E_w	B_c			
22	KT 222610	6.9	22	26	10	8 220	11 500	25 000
	KT 222613	9.1	22	26	13	10 200	15 200	25 000
	KT 222617	11.6	22	26	17	13 500	21 600	25 000
	KTW 222625	17.7	22	26	25	17 100	29 400	25 000
	KT 222720	17.9	22	27	20	17 400	25 700	25 000
	KT 222726	22.5	22	27	26	22 500	35 800	25 000
	KT 222817	18.4	22	28	17	17 500	23 000	25 000
	KT 222912	16.1	22	29	12	12 900	14 000	25 000
	KT 222916	21	22	29	16	17 600	20 900	25 000
	KT 222917	22.5	22	29	17	18 700	22 600	25 000
	KT 222918	23.5	22	29	18	19 800	24 400	25 000
	KT 222920	26.5	22	29	20	20 900	26 100	25 000
	KT 223015	23.5	22	30	15	17 900	19 700	25 000
	KT 223230	52.5	22	32	30	36 400	42 700	25 000
	KT 223232	56	22	32	32	38 800	46 300	25 000
	23	KT 232824	22	23	28	24	21 600	34 500
KT 232913		15.1	23	29	13	13 800	17 200	20 000
KT 233015		21	23	30	15	17 300	20 800	20 000
KT 233016		22	23	30	16	18 600	22 600	20 000
24	KT 242813	9.9	24	28	13	10 800	16 800	20 000
	KT 242816	12	24	28	16	13 400	22 200	20 000
	KTW 242834	27	24	28	34	21 600	40 700	20 000
	KT 242913	12.8	24	29	13	12 700	17 600	20 000
	KT 243020	23.5	24	30	20	20 300	28 500	20 000

1N=0.102kgf=0.2248lbs.
1mm=0.03937inch

NEEDLE ROLLER CAGES FOR GENERAL USAGE



Shaft dia. 25 – 32mm

Shaft dia. mm	Identification number	Mass (Ref.) g	Boundary dimensions mm			Basic dynamic load rating C N	Basic static load rating C_0 N	Allowable rotational speed ⁽¹⁾ rpm
			F_w	E_w	B_c			
25	KT 252910	7.9	25	29	10	8 940	13 300	20 000
	KT 252913	10.3	25	29	13	11 100	17 600	20 000
	KT 253013	13.3	25	30	13	13 100	18 600	20 000
	KT 253016	16.2	25	30	16	16 300	24 600	20 000
	KT 253017	17.1	25	30	17	17 300	26 600	20 000
	KT 253020	20	25	30	20	18 600	29 100	20 000
	KT 253113	16.2	25	31	13	14 300	18 400	20 000
	KT 253116	19.6	25	31	16	17 800	24 400	20 000
	KT 253117	20.5	25	31	17	19 000	26 500	20 000
	KT 253120	25	25	31	20	21 200	30 500	20 000
	KT 253216	23.5	25	32	16	19 400	24 500	20 000
	KT 253224	35	25	32	24	27 700	38 700	20 000
	KT 253515	33	25	35	15	22 600	23 800	20 000
	KT 253525	48	25	35	25	32 500	37 900	20 000
KT 253530	58	25	35	30	39 100	48 000	20 000	
26	KT 263013	10.7	26	30	13	11 400	18 400	19 000
	KT 263832	79.5	26	38	32	47 200	55 300	19 000
28	KT 283313	14.8	28	33	13	13 800	20 700	18 000
	KT 283317	18.9	28	33	17	18 300	29 500	18 000
	KT 283327	29	28	33	27	26 300	47 300	18 000
	KT 283417	23	28	34	17	20 300	29 900	18 000
	KT 283516	26	28	35	16	20 100	26 500	18 000
	KT 283528	44.5	28	35	28	33 200	50 600	18 000
	KT 283620	38.5	28	36	20	26 500	34 700	18 000
	KT 284138	110	28	41	38	58 700	71 100	18 000

Note⁽¹⁾ Allowable rotational speed applies to oil lubrication. For grease lubrication, a maximum of 50% of this value is allowable.

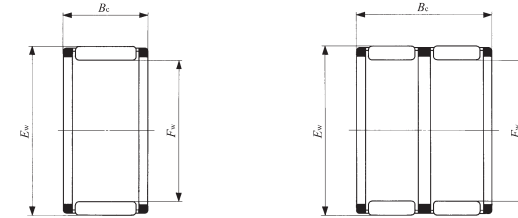

KT

KTW

Shaft dia. mm	Identification number	Mass (Ref.) g	Boundary dimensions mm			Basic dynamic load rating C N	Basic static load rating C_0 N	Allowable rotational speed ⁽¹⁾ rpm
			F_w	E_w	B_c			
30	KT 303513	15.6	30	35	13	14 100	21 700	17 000
	KT 303516	18.9	30	35	16	17 500	28 700	17 000
	KT 303517	20	30	35	17	18 700	31 100	17 000
	KT 303524	28.5	30	35	24	24 900	45 100	17 000
	KT 303527	31.5	30	35	27	27 900	52 100	17 000
	KT 303613	19.1	30	36	13	15 800	22 100	17 000
	KT 303620	29.5	30	36	20	23 300	36 500	17 000
	KT 303630	41.5	30	36	30	33 200	57 500	17 000
	KT 303715	26	30	37	15	19 500	26 000	17 000
	KT 303716	27.5	30	37	16	20 800	28 400	17 000
	KT 303720	35	30	37	20	24 700	35 400	17 000
	KT 303723	39.5	30	37	23	28 500	42 500	17 000
	KT 303818	36.5	30	38	18	26 200	34 800	17 000
	KT 303824	48.5	30	38	24	33 200	47 200	17 000
	KT 304232	93	30	42	32	54 000	68 100	17 000
	KTW 304237	117	30	42	37	55 900	71 300	17 000
32	KT 323713	16.7	32	37	13	14 900	23 700	16 000
	KT 323717	21.5	32	37	17	19 600	33 900	16 000
	KT 323723	28.5	32	37	23	24 400	44 800	16 000
	KT 323813	20.5	32	38	13	16 800	24 400	16 000
	KT 323820	31.5	32	38	20	24 800	40 300	16 000
	KT 323916	29	32	39	16	21 600	30 200	16 000
	KT 323920	37	32	39	20	25 600	37 700	16 000
	KT 324519	63.5	32	45	19	33 700	35 900	16 000
	KT 324525	84.5	32	45	25	45 600	53 000	16 000
	KT 324532	109	32	45	32	58 500	73 000	16 000
KT 324550	162	32	45	50	81 500	111 000	16 000	

1N=0.102kgf=0.2248lbs.
1mm=0.03937inch

NEEDLE ROLLER CAGES FOR GENERAL USAGE



Shaft dia. 35 – 52 mm

haft dia. mm	Identification number	ass (Ref.) g	Boundary dimensions mm			Basic dynamic load rating C N	Basic static load rating C ₀ N	Allowable rotational speed ⁽¹⁾ rpm
			F _w	E _w	B _c			
35	KT 354013	18.1	35	40	13	15 500	25 800	14 000
	KT 354017	23	35	40	17	20 500	36 900	14 000
	KT 354026	34.5	35	40	26	28 700	56 800	14 000
	KT 354113	22.5	35	41	13	17 700	26 800	14 000
	KT 354216	32	35	42	16	23 100	33 900	14 000
	KT 354218	35.5	35	42	18	26 000	39 500	14 000
	KT 354220	40.5	35	42	20	27 400	42 300	14 000
	KT 354230	59	35	42	30	40 600	70 300	14 000
	KT 354525	68.5	35	45	25	42 100	57 900	14 000
36	KT 364216	27.5	36	42	16	21 900	35 700	14 000
38	KT 384417	30.5	38	44	17	23 800	40 400	13 000
	KT 384620	50	38	46	20	30 500	45 400	13 000
	KT 384632	80	38	46	32	45 400	75 700	13 000
40	KT 404513	20.5	40	45	13	16 800	29 800	12 000
	KT 404517	26.5	40	45	17	22 200	42 700	12 000
	KT 404527	41	40	45	27	32 400	69 200	12 000
	KT 404817	44	40	48	17	28 100	41 600	12 000
	KT 404820	52.5	40	48	20	31 400	48 000	12 000
	KT 404825	64.5	40	48	25	39 300	64 000	12 000
	KT 404834	87.5	40	48	34	51 100	89 600	12 000
	KT 405015	48.5	40	50	15	28 200	35 900	12 000
	KT 405017	56.5	40	50	17	30 200	39 200	12 000
	KT 405020	61	40	50	20	35 700	48 600	12 000
	KTW 405238	158	40	52	38	65 000	93 000	12 000
	KT 405432	144	40	54	32	66 800	87 200	12 000
	KT 405450	215	40	54	50	93 600	134 000	12 000
	KT 405463	270	40	54	63	115 000	175 000	12 000

Note⁽¹⁾ Allowable rotational speed applies to oil lubrication. For grease lubrication, a maximum of 50% of this value is allowable.

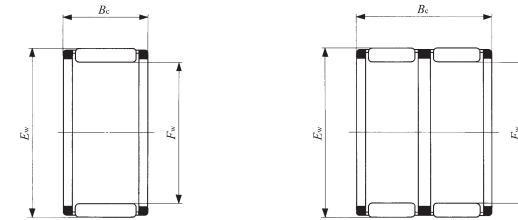

KT

KTW

haft dia. mm	Identification number	ass (Ref.) g	Boundary dimensions mm			Basic dynamic load rating C N	Basic static load rating C ₀ N	Allowable rotational speed ⁽¹⁾ rpm
			F _w	E _w	B _c			
41	KT 414835	78.5	41	48	35	47 800	90 800	12 000
42	KT 424717	27.5	42	47	17	22 500	44 200	12 000
	KT 424815	30	42	48	15	22 400	38 600	12 000
	KT 424816	32	42	48	16	24 000	42 100	12 000
	KT 425020	55	42	50	20	32 400	50 600	12 000
	KT 425030	80.5	42	50	30	48 200	84 400	12 000
45	KT 455017	29.5	45	50	17	23 300	47 100	11 000
	KT 455027	46	45	50	27	34 800	79 000	11 000
	KT 455320	58	45	53	20	33 200	53 300	11 000
	KT 455325	71.5	45	53	25	41 500	71 100	11 000
	KT 455330	86	45	53	30	47 800	85 300	11 000
	KT 455335	101	45	53	35	53 900	99 500	11 000
48	KT 485320	37	48	53	20	26 800	57 600	10 000
	KT 485420	46	48	54	20	30 600	60 400	10 000
50	KT 505520	38.5	50	55	20	27 100	59 300	10 000
	KT 505527	50.5	50	55	27	35 600	84 100	10 000
	KT 505820	65	50	58	20	35 900	61 100	10 000
	KT 505825	80	50	58	25	44 900	81 500	10 000
	KT 505830	96.5	50	58	30	51 700	97 800	10 000
	KT 505835	113	50	58	35	58 300	114 000	10 000
52	KT 525817	41	52	58	17	28 300	56 000	9 500
	KT 526024	80	52	60	24	44 000	80 800	9 500

1N=0.102kgf=0.2248lbs.
1mm=0.03937inch

NEEDLE ROLLER CAGES FOR GENERAL USAGE



Shaft dia. 55 – 100mm

Shaft dia. mm	Identification number	Mass (Ref.) g	Boundary dimensions mm			Basic dynamic load rating C N	Basic static load rating C_0 N	Allowable rotational speed ⁽¹⁾ rpm
			F_w	E_w	B_c			
55	KT 556020	42.5	55	60	20	28 600	66 000	9 000
	KT 556027	55.5	55	60	27	37 600	93 900	9 000
	KT 556120	52	55	61	20	32 600	68 500	9 000
	KT 556315	52.5	55	63	15	29 400	48 700	9 000
	KT 556320	71	55	63	20	37 400	66 400	9 000
	KT 556325	87	55	63	25	46 800	88 600	9 000
58	KT 586320	44.5	58	63	20	29 300	69 400	8 500
	KT 586420	54.5	58	64	20	33 600	72 500	8 500
60	KT 606520	45.5	60	65	20	29 700	71 100	8 500
	KT 606820	76.5	60	68	20	38 900	71 700	8 500
	KT 606825	94	60	68	25	48 600	95 600	8 500
	KT 606827	101	60	68	27	52 400	105 000	8 500
	KT 607236	205	60	72	36	86 700	152 000	8 500
63	KT 637120	79.5	63	71	20	39 500	74 400	8 000
65	KT 657320	83.5	65	73	20	41 200	79 600	7 500
	KT 657330	124	65	73	30	59 300	127 000	7 500
68	KT 687620	86.5	68	76	20	41 800	82 200	7 500
70	KT 707820	89	70	78	20	42 500	84 900	7 000
	KT 707830	132	70	78	30	61 200	136 000	7 000
72	KT 728020	91.5	72	80	20	43 200	87 500	7 000
75	KT 758320	94.5	75	83	20	43 800	90 200	6 500
	KT 758325	116	75	83	25	54 800	120 000	6 500
	KT 758330	141	75	83	30	63 100	144 000	6 500
	KT 758335	164	75	83	35	71 200	168 000	6 500

Note⁽¹⁾ Allowable rotational speed applies to oil lubrication. For grease lubrication, a maximum of 50% of this value is allowable.

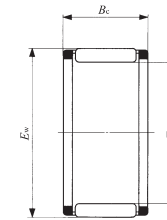

KT

Shaft dia. mm	Identification number	Mass (Ref.) g	Boundary dimensions mm			Basic dynamic load rating C N	Basic static load rating C_0 N	Allowable rotational speed ⁽¹⁾ rpm
			F_w	E_w	B_c			
80	KT 808822	110	80	88	22	49 700	108 000	6 000
	KT 808825	123	80	88	25	56 400	127 000	6 000
	KT 808830	149	80	88	30	65 000	153 000	6 000
85	KT 859112	44.5	85	91	12	25 200	56 700	6 000
	KT 859325	130	85	93	25	57 800	134 000	6 000
	KT 859330	157	85	93	30	66 600	161 000	6 000
90	KT 909825	138	90	98	25	60 400	145 000	5 500
	KT 909830	167	90	98	30	69 600	174 000	5 500
95	KT 9510330	175	95	103	30	70 900	182 000	5 500
100	KT 10010830	184	100	108	30	72 500	191 000	4 500

1N=0.102kgf=0.2248lbs.
1mm=0.03937inch

NEEDLE ROLLER CAGES FOR ENGINE CONNECTING RODS

- Needle Roller Cages for Big End
- Needle Roller Cages for Small End

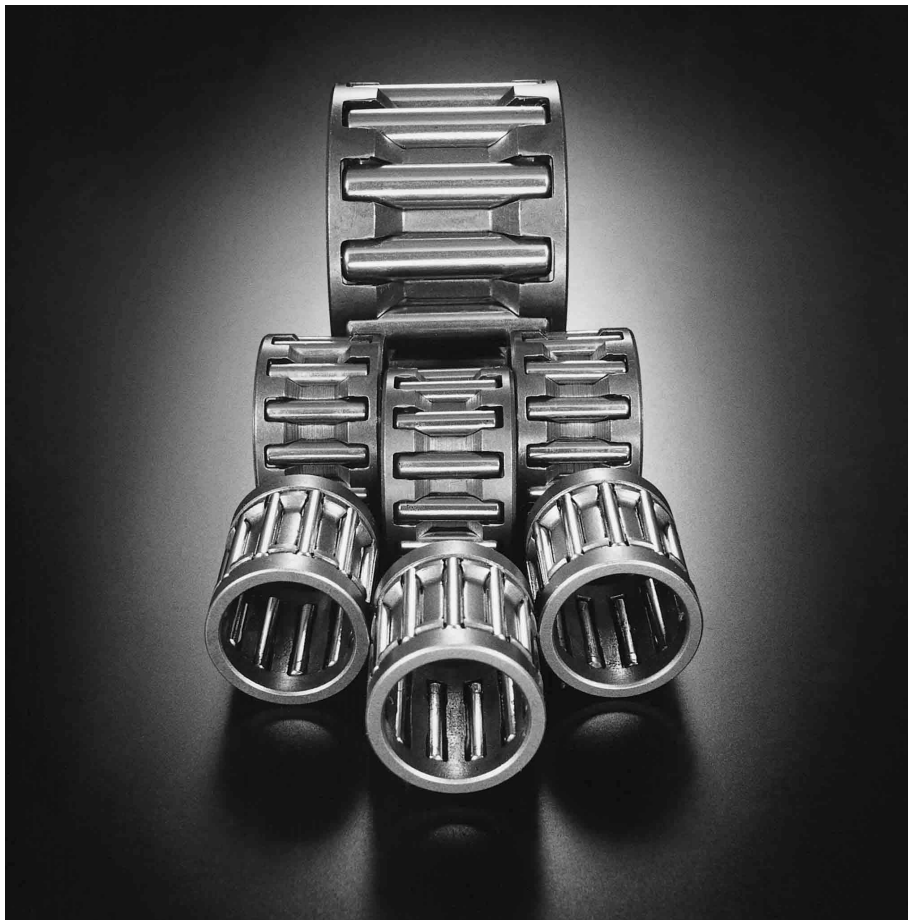

Structure and Features

TURNUP Needle Roller Cages for Engine Connecting Rods are bearings for use in engine connecting rods.

These bearings have superior performance proven in high performance engines of racing motor cycles, and are widely used in small motor vehicles, motor cycles, outboard marines, snow mobiles, high-speed compressors, etc. and also in general-purpose engines. Bearings for engine connecting rods are used under extremely severe and complex operating conditions such as heavy shock loads, high speeds, high temperatures and stringent lubrication.

Needle Roller Cages for Engine Connecting Rods are lightweight, and have high load ratings and high rigidity as well as superior wear resistance to withstand these severe conditions.

Types

In Needle Roller Cages for Engine Connecting Rods, the types shown in Table 1 are available.

Table 1 Types

Type	For big end	For small end
Model code	KT...EG	KTV...EG

Structures of Needle Roller Cages for Engine Connecting Rods

KT...EG

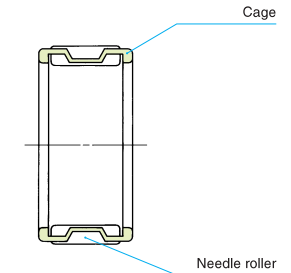

KTV...EG

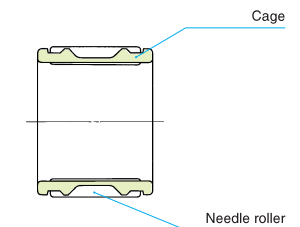

C

KT...EG
KTV...EG

Needle Roller Cages for Big End KT...EG

These roller cages are subjected to acceleration and deceleration during their rotating and epicyclic motion due to crank shaft rotation. To withstand such conditions, they are made of a special alloy and are lightweight with high rigidity.

They are guided on their outer periphery surface with super or lubricating properties.

For the purpose of using them under severe conditions such as high rotational speed and stringent lubrication, bearings plated with non-ferrous metal are also available on request.

High-load capacity and high-rigidity cages to be used for racing motor cycles (See the photo below.), split needle cages for solid (one-piece) type crank-shafts and other special specifications cages of various types are also available. Please consult TURNUP when required.



High-load capacity and high-rigidity cage KTZ...EG

Needle Roller Cages for Small End KTV...EG

These roller cages oscillate at high speeds with a limited loading zone under heavy shock loads. Thus, these cages are designed to be lightweight and have high rigidity with a well-balanced structure. In these cages, a number of needle rollers having a small diameter are incorporated to reduce the rolling contact stress in the loading zone.

Needle Roller Cages for Small End are classified into two types, the outer surface guide type and the inner surface guide type. This classification is shown in the table of dimensions.

In the outer surface guide type, the cage is guided by the sliding contact between the inner surface of the connecting rod and the outer surface of the cage.

In the inner surface guide type, the cage is guided by the sliding contact between the outer surface of the pin and the inner surface of the cage.

Identification Number

The identification number of Needle Roller Cages for Engine Connecting Rods consists of a model code, dimensions and any supplemental codes as shown below.

Examples of identification number

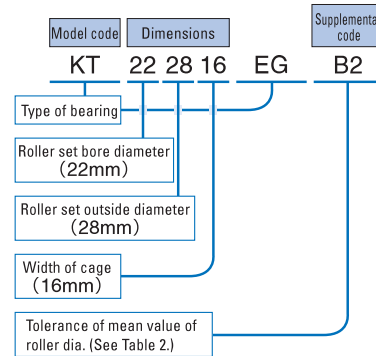

Accuracy

The dimension tolerance of needle rollers of Needle Roller Cages for Engine Connecting Rods is defined as shown in Table 2. When the classification symbol is not indicated in the dimension, the dimension number is the dimension number, the classification symbol "B2" is applied.

The tolerance of the cage width B_c is 0.2~0.4 mm. But the cage width B_c column in the dimension table is defined with the following width tolerance.

- : 0~0.2 mm
- : -0.1~0.3 mm

Table 2 Tolerances of needle roller diameter unit: μm

Class	Classification symbol ⁽¹⁾	Tolerance of mean value of roller dia. ⁽²⁾
Standard	B 2	0~2
	B 4	-2~4
Semi-standard	B 6	-4~6
	B 8	-6~8
	B10	-8~10

Notes⁽¹⁾ The classification symbol is indicated at the end of the identification number.

⁽²⁾ Tolerances for circularity are based on JIS B 1506-1991 (Roller for rolling bearings).

Clearance

Radial internal clearances are selected according to the type of engine and the operating conditions (rotational speed, load, lubricating conditions, etc.). If a bearing is used with an inadequate clearance, bearing troubles such as seizure, early flaking and noise increase may occur, leading to an engine failure. Therefore, it is necessary to select the clearance carefully according to test results and experience.

Recommended radial internal clearances are shown in Table 3. When operating at high speeds, it is recommended to select the upper limit of the clearance.

Fit

To obtain the recommended clearance shown in Table 3, it is general practice to match a connecting rod, crank pin or piston pin and needle roller cage of suitable tolerances for assembly.

Precautions for Use

When designing connecting rod, crank pin and piston pin, the following precautions should be taken, because the raceways are subjected to loads under extremely severe conditions.

1 Material

It is recommended to use carburizing steel because the raceways are subjected to fluctuating loads with frequent and heavy shock loads. Generally, chromium molybdenum steel is used. Nickel chromium molybdenum steel is also used.

2 Hardness

The recommended surface hardness of the raceways is 697~800HV (60~64HRC). While the effective hardening depth differs depending on the applications, the general value is 0.6~1.2 mm.

3 Surface roughness

To minimize initial wear and to extend life, it is recommended that the surface roughness of the crank pin and piston pin be $0.1 \mu\text{m}R_a$ or less, and the surface roughness of the connecting rod large end and small end bore be $0.2 \mu\text{m}R_a$ or less.

4 Accuracy

Circularity and cylindricity of connecting rod, piston pin and crank pin are as shown in Table 4.

5 Parallelism and torsional accuracy of connecting rod bores

$L \pm 0.02$ mm and $E \pm 0.02$ mm shown in Fig. 1 indicate the parallelism and torsional accuracy between the big end and small end bore of the connecting rod, respectively. The tolerance range is 0.04 mm or less per 100 mm in case of general-purpose engine and 0.02 mm or less for a high-speed engine such as racing motorcycle engine. When these accuracy conditions are not satisfied, the axial forces on the needle roller cage and connecting rod will increase, directly leading to a failure such as seizure. Careful consideration is required.

Table 3 Recommended radial internal clearance unit: μm

Shaft dia. mm		Big end	Small end
Over	Incl.		
—	18	$(d_p - 6) \sim d_p$	3~15
18	30	$(d_p - 8) \sim d_p$	
30	40	$(d_p - 12) \sim d_p$	

Remark d_p is obtained using the following formula for roller pitch circle diameter in millimeters, and changing the unit from millimeters to micrometers.

$$\text{Roller pitch circle dia.} = \frac{F_w + E_w}{2}$$

Example KT 222814 EG for big end
Recommended clearance is; 17~25 μm

Table 4 Accuracy of connecting rod, piston pin and crank pin unit: μm

Range of dia. mm		Crank pin diameter d_1 Piston pin diameter d_2		Big end bore D_1 Small end bore D_2	
Over	Incl.	Circularity MAX.	Cylindricity MAX.	Circularity MAX.	Cylindricity MAX.
—	18	1	2	2	3
18	30	2	3	3	4
30	40	3	4	4	5

Remark Refer to Fig. 1 for the dimension symbols.

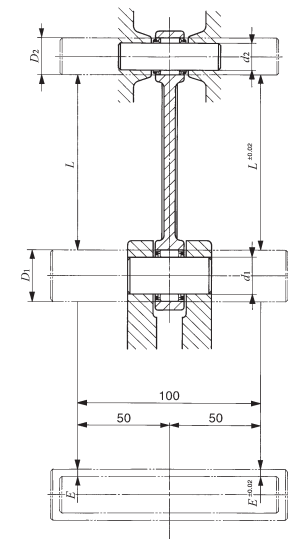
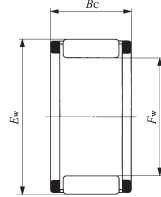

Fig.1
1N=0.102kgf=0.248lbs.
1mm=0.03937inch

NEEDLE ROLLER CAGES FOR ENGINE CONNECTING RODS

Needle Roller Cages for Big End



KT...EG

Shaft dia. 8 – 32mm

Shaft dia. mm	Identification number	Mass (Ref.) g	Boundary dimensions mm			Basic dynamic load rating C N	Basic static load rating C ₀ N
			F _w	E _w	B _c		
8	KT 8128 EG	2.1	8	12	8	3 280	2 660
10	KT 101410 EG	3.2	10	14	10	4 900	4 680
12	KT 121610 EG	3.8	12	16	10	5 650	5 890
	KT 121710 EG	5.3	12	17	10	6 670	6 380
14	KT 14199.7 EG	5.7	14	19	9.7	6 120	5 880
	KT 141910 EG	5.7	14	19	10	6 640	6 530
15	KT 15199 EG	4.2	15	19	9	5 790	6 460
	KT 152010 EG	6.1	15	20	10	7 100	7 260
16	KT 162211.5 EG	9.5	16	22	■11.5	9 550	9 660
	KT 162212 EG	9.7	16	22	12	10 500	10 900
18	KT 182210 EG	5.7	18	22	10	7 500	9 560
	KT 182411.6 EG	11	18	24	■11.6	10 600	11 500
	KT 182412 EG	11	18	24	12	11 800	13 100
20	KT 202612 EG	12	20	26	12	12 400	14 300
	KT 202614 EG	13.8	20	26	14	13 000	15 200
	KT 202814 EG	20	20	28	●14	15 700	16 100
22	KT 222814 EG	14.9	22	28	14	13 600	16 600
	KT 222816 EG	17.5	22	28	16	15 700	19 800
	KT 222912 EG	15.2	22	29	12	12 900	14 000
	KT 223215 EG	30	22	32	15	21 300	21 500
23	KT 232913 EG	14.9	23	29	13	12 800	15 600
24	KT 243015 EG	17.9	24	30	15	14 200	18 000
	KT 243016 EG	18.2	24	30	16	16 300	21 500
	KT 243120 EG	28	24	31	20	20 800	26 400
30	KT 303818 EG	35.5	30	38	18	24 900	32 600
32	KT 324220 EG	54	32	42	20	31 900	39 400

Needle Roller Cages for Small End

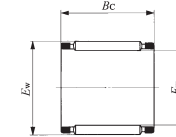

KTV...EG

Shaft dia. 9 – 18mm

Shaft dia. mm	Identification number	Mass (Ref.) g	Boundary dimensions mm			Basic dynamic load rating C N	Basic static load rating C ₀ N	Cage guide type
			F _w	E _w	B _c			
9	KTV 91211.5 EG	2.8	9	12	●11.5	3 900	4 070	Outer surface guide
	KTV 91214 EG	3.5	9	12	14	4 440	4 810	Inner surface guide
10	KTV 101316 EG	4.5	10	13	16	4 400	4 880	Inner surface guide
	KTV 101410 EG	3.8	10	14	10	4 520	4 220	Inner surface guide
	KTV 101411 EG	4.1	10	14	11	5 060	4 880	Outer surface guide
	KTV 101412.5 EG	4.8	10	14	●12.5	5 590	5 540	Inner surface guide
10.5	KTV 10.51415 EG	5.1	10.5	14	15	5 710	6 270	Outer surface guide
12	KTV 121514.3 EG	4.3	12	15	●14.3	5 840	7 390	Outer surface guide
	KTV 121613 EG	5.6	12	16	13	7 020	7 800	Outer surface guide
	KTV 121615.5 EG	6.8	12	16	●15.5	7 600	8 600	Outer surface guide
14	KTV 141812 EG	6	14	18	12	6 780	7 760	Inner surface guide
	KTV 141816.5 EG	8.2	14	18	16.5	9 180	11 500	Outer surface guide
	KTV 141822 EG	10.8	14	18	●22	9 950	12 600	Inner surface guide
16	KTV 162019 EG	10.6	16	20	19	10 800	14 600	Outer surface guide
	KTV 162022 EG	12.7	16	20	22	11 400	15 700	Inner surface guide
18	KTV 182223.5 EG	14.9	18	22	■23.5	13 000	19 300	Inner surface guide
	KTV 182321 EG	16.4	18	23	21	14 400	18 900	Inner surface guide

1N=0.102kgf=0.2248lbs.
1mm=0.03937inch

MACHINED TYPE NEEDLE ROLLER BEARINGS

- Machined Type Caged Needle Roller Bearings
- Machined Type Guide Needle Roller Bearings
- Capilube Machined Type Needle Roller Bearings



Structure and Features

TURNUP Machined Type Needle Roller Bearings are bearings with a low sectional height and large load ratings.

The outer ring has high rigidity and can easily be used even for light alloy housings. These bearings are available in metric series and inch series, both of which have the caged type and the full complement type. It is therefore possible to select a suitable bearing for use under various conditions such as heavy loads and high-speed or low-speed rotations. In addition, there are bearings with and without an inner ring. As the type without inner ring uses a shaft as the raceway surface, a compact design is possible.

D
NA
TAFI
TRI
BRI

Structures of Machined Type Needle Roller Bearings

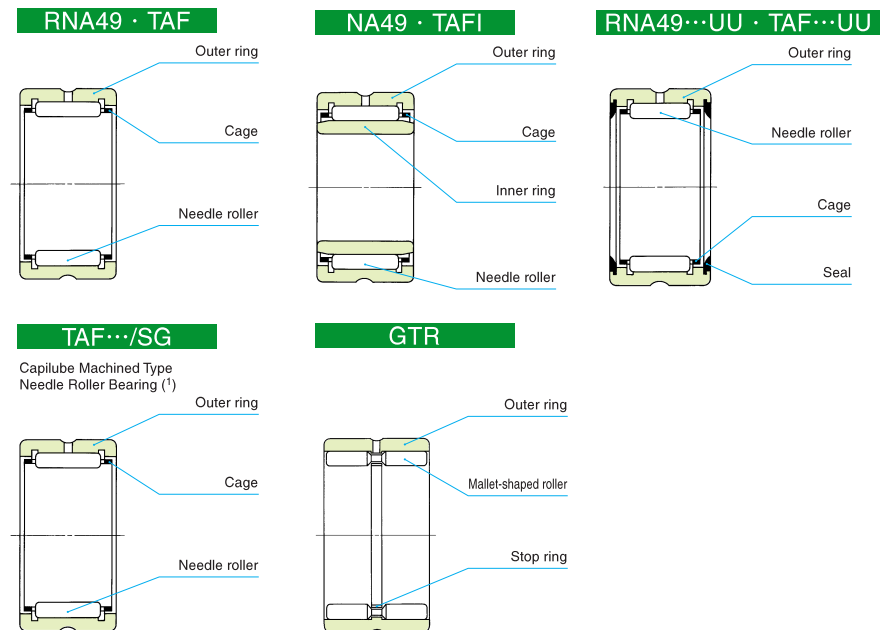

Note(*) For the details of Capilube, please refer page A55

Types

Machined Type Needle Roller Bearings are available in various types shown in Table 1.

Table 1.1 Type of bearing (Standard type)

Series	Type	Caged Needle Roller Bearings		Guide Needle Roller Bearings	
		Without inner ring	With inner ring	Without inner ring	With inner ring
Metric series	Dimension series 49	RNA 49	NA 49	GTR	GTRI
	Dimension series 69	RNA 69	NA 69		
	Dimension series 48	RNA 48	NA 48		
	For heavy duty	TR	TRI		
	For light duty	TAF	TAFI		
Inch series		BR	BRI	GBR	GBRI

Table 1.2 Type of bearing (With seal)

Series	Type	Caged Needle Roller Bearings		Guide Needle Roller Bearings	
		Without inner ring	With inner ring	Without inner ring	With inner ring
Metric series	Dimension series 49	Two side seals	RNA 49...UU	NA 49...UU	
		One side seal	RNA 49...U	NA 49...U	
	Dimension series 69	Two side seals	RNA 69...UU	NA 69...UU	
		One side seal	RNA 69...U	NA 69...U	
Inch series	Two side seals	BR...UU	BRI...UU	GBR...UU	GBRI...UU
	One side seal	BR...U	BRI...U	GBR...U	GBRI...U

Caged Needle Roller Bearings

This type of bearing combines a collared outer ring with the TURNUP's unique lightweight rigid cage and needle rollers.

During operation, needle rollers are guided precisely by the cage, and an ideal load distribution is obtained.

Caged Needle Roller Bearings without Inner Ring

As shown in the section "Design of shaft and housing" on page A44, any desired radial clearance can be selected by assembling this type of bearing with a shaft which is heat-treated and finished by grinding. These bearings are free from the effects on dimensional accuracy caused by assembling an inner ring,

so that the rotational accuracy is improved. Also, the shaft rigidity can be improved as the shaft diameter can be increased by an amount corresponding to the inner ring thickness.

Caged Needle Roller Bearings with Inner Ring

This type of bearing is used when the shaft cannot be heat-treated and finished by grinding. The outer and inner rings are separable and a small relief clearance is provided on both sides of the inner ring raceway to facilitate bearing mounting. In the TRI and BRI series, the width of the inner ring is larger than that of the outer ring.

Due to heat expansion during operation or mounting errors, the inner or outer ring may be shifted axially and the whole length of the rollers may not be in contact with the raceway. Therefore, attention should be paid to the allowable axial shift S as shown in the table of dimensions.

Needle Roller Bearings with Seal

These bearings are sealed types of the NA49, NA69 and BRI series bearings, in which a seal is installed on one side (type with one seal) or both sides (type with two seals) of the bearing. The seal is made of special synthetic rubber and effectively prevents dust penetration and grease leakage.

Guide Needle Roller Bearings

These bearings are full complement type bearings and use mallet-shaped rollers which are guided accurately by the guide rail located at the center of the outer ring raceway and the guide groove of the mallet-shaped roller. This minimizes skewing (tilting of the roller from its rotating axis), which is normally a weak point of full complement bearings, and improves the rotational accuracy. This type of bearing is especially suitable for heavy loads, shock loads and oscillating motions.

The bearings are available in metric and inch series. Bearings with and without inner rings are available in both series. In bearings with an inner ring, the width of the inner ring is larger than that of the outer ring. The GBRI series of the inch series includes types with a seal or seals which are incorporated on one or both sides.

Identification Number

The identification number of Machined Type Needle Roller Bearings consists of a model code, dimensions, any supplemental codes and a classification symbol. Examples are shown below.

Examples of identification number

Example 1

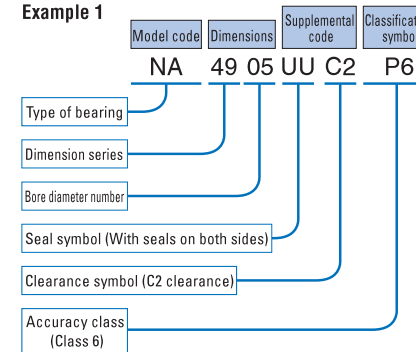

Example 2

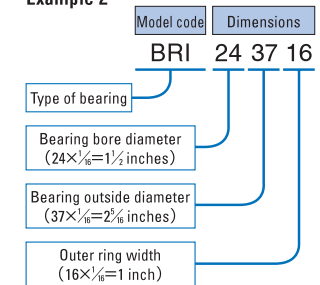

Accuracy

Machined Type Needle Roller Bearings are manufactured based on JIS (See page A31.). The tolerances for the smallest single roller set bore diameter of bearings without inner ring are based on Table 14 on page A33. For BR and BRI series, the accuracy is based on Table 2 and the tolerances for the smallest single roller set bore diameter are based on Table 3.

Table 2 Accuracy of inner and outer rings of inch series BR and BRII (1)

unit: μm

d or D Nominal bearing bore dia. or outside dia. mm		Δ_{dmp} Single plane mean bore diameter deviation		Δ_{Dmp} Single plane mean outside diameter deviation		$\Delta_{Bs} (\Delta_{Cs})$ Deviation of a single inner (or outer) ring width		K_{ia} Radial runout of assembled bearing inner ring	K_{ea} Radial runout of assembled bearing outer ring
Over	Incl.	High	Low	High	Low	High	Low	Max.	Max.
—	19.050	0	-10	—	—	0	-130	10	—
19.050	30.162	0	-13	0	-13	0	-130	13	15
30.162	50.800	0	-13	0	-13	0	-130	15	20
50.800	82.550	0	-15	0	-15	0	-130	20	25
82.550	120.650	0	-20	0	-20	0	-130	25	35
120.650	184.150	—	—	0	-25	0	-130	30	45

Remark d for Δ_{dmp} , Δ_{Bs} , Δ_{Cs} and K_{ia} , and D for Δ_{Dmp} and K_{ea}
Note(1) For GBR, GBRI, refer to Metric series tables on page A31-A32.

Table 3 Tolerances for smallest single roller set bore diameter $F_{ws \text{ min}}$ of inch series BR⁽¹⁾ unit: μm

F_w Nominal roller set bore diameter mm		$\Delta F_{ws \text{ min}}$ Deviation of smallest single roller set bore diameter	
Over	Incl.	High	Low
—	18.034	+43	+20
18.034	30.226	+46	+23
30.226	41.910	+48	+25
41.910	50.038	+51	+25
50.038	70.104	+53	+28
70.104	80.010	+58	+28
80.010	102.108	+61	+31

Note⁽¹⁾ For GBR, refer to Metric series tables on page A33.

Clearance

Radial internal clearances of Machined Type Needle Roller Bearings are made to the CN clearance shown in Table 18 on page A37. Radial internal clearances of BRI series are based on Table 4.

Table 4 Radial internal clearance of inch series BRI⁽¹⁾ unit: μm

F_w Nominal roller set bore diameter mm		Radial internal clearance	
Over	Incl.	Min.	Max.
—	18.034	33	66
18.034	25.908	41	76
25.908	30.226	46	82
30.226	35.052	48	86
35.052	41.910	50	89
41.910	50.038	50	92
50.038	70.104	56	99
70.104	80.010	56	104
80.010	100.076	63	117
100.076	102.108	68	127

Note⁽¹⁾ For GBRI, refer to Metric series tables on page A37.

Table 5 Bearings with prepacked grease

○ : With prepacked grease × : Without prepacked grease

Bearing type		Standard type	With seals on both sides	With a seal on one side
Caged Needle Roller Bearings	Metric series	RNA, NA	×	○
		TR, TRI	×	—
		AF, TAFI	×	—
	Inch series	BR, BRI	×	○
Guide Needle Roller Bearings	Metric series	GTR, GTRI	×	—
	Inch series	GBR, GBRI	×	○

Fit

The recommended fits for Machined Type Needle Roller Bearings are shown in Tables 22 to 24 on pages A41 and A42.

Lubrication

Bearings with prepacked grease are shown in Table 5. ALVANIA GREASE S2 (SHELL) is prepacked as the lubricating grease.

In the case of bearings without prepacked grease, perform proper lubrication. Operating them without lubrication will increase the wear of the rolling contact surfaces and shorten their lives.

Oil Hole

Table 6.1 shows the number of oil holes of the outer ring and Table 6.2 shows the number of oil holes of the inner ring.

When an outer ring with an oil hole is especially required for the type without an oil hole, add "—OH" before the clearance symbol in the identification number. When an outer ring with an oil hole and an oil groove is required for the type without an oil hole, attach "—OG" before the clearance symbol.

Example: AFI 203216 —OH C2 P6

When an outer ring with multiple oil holes or an inner ring with an oil hole(s) is required, please consult

Table 6.1 Number of oil holes of the outer ring

Bearing type		Nominal roller set bore diameter F_w mm	Number of oil holes of the outer ring		
			Standard type	With seals on both sides	With a seal on one side
Caged Needle Roller Bearings	Metric series	RNA, NA	1	1	1
		TR, TRI	1	—	—
		TAF, TAFI	0	—	—
	Inch series	BR, BRI	1	—	—
		GBR, GBRI	2	1	1
Guide Needle Roller Bearings	Metric series	GTR, GTRI	1	—	—
	Inch series	GBR, GBRI	1	1	1

Remark The type with an oil hole (s) is provided with an oil groove.

Table 6.2 Number of oil holes of the inner ring

Bearing type		Nominal bearing bore diameter d mm	Number of oil holes of the inner ring		
			Standard type	With seals on both sides	With a seal on one side
Caged Needle Roller Bearings	Metric series	NA	0	0	0
		TRI	0	0	0
		TAFI	0	—	—
	Inch series	BRI	1	1	1
		GBRI	2	1	1
Guide Needle Roller Bearings	Metric series	GTRI	0	—	—
	Inch series	GBRI	0	0	0

Remark The type with an oil hole (s) is provided with an oil groove.

Matched Set Bearings

When using two or more Machined Type Needle Roller Bearings adjacent to each other on the same shaft, it is necessary to obtain an even load distribution. On request, a set of bearings is available, in which bearings are matched to obtain an even load distribution.

Mounting

Mounting dimensions for Machined Type Needle Roller Bearings are shown in the table of dimensions.

1N=0.102kgf=0.2248lbs.
1mm=0.03937inch

CAPILUBE MACHINED TYPE NEEDLE ROLLER BEARINGS

Without Inner Ring

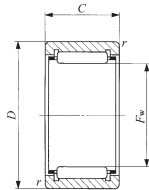

$F_w \leq 26$
(Without oil hole and oil groove)

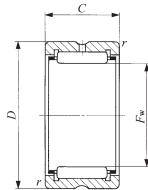

$F_w > 26$
(With oil hole and oil groove)

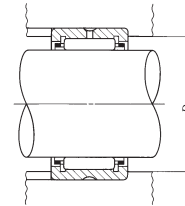

Shaft dia. 12 – 45mm

Shaft dia.	Identification number	Mass (Ref.) g	Boundary dimensions mm				Standard mounting dimension D_a Max. mm
			F_w	D	C	$r_s \text{ min}^{(1)}$	
12	TAF 121912/SG	12.5	12	19	12	0.3	17
	TAF 121916/SG	16.8	12	19	16	0.3	17
15	TAF 152316/SG	23.5	15	23	16	0.3	21
	TAF 152320/SG	29	15	23	20	0.3	21
18	TAF 182616/SG	26.5	18	26	16	0.3	24
	TAF 182620/SG	33	18	26	20	0.3	24
20	TAF 202816/SG	28.5	20	28	16	0.3	26
	TAF 202820/SG	37	20	28	20	0.3	26
22	TAF 223016/SG	31	22	30	16	0.3	28
	TAF 223020/SG	39	22	30	20	0.3	28
25	TAF 253316/SG	35	25	33	16	0.3	31
	TAF 253320/SG	43.5	25	33	20	0.3	31
30	TAF 304020/SG	67	30	40	20	0.3	38
	TAF 304030/SG	101	30	40	30	0.3	38
45	TAF 455520/SG	95.5	45	55	20	0.3	53
	TAF 455530/SG	144	45	55	30	0.3	53

Note⁽¹⁾ Minimum allowable value of chamfer dimension r .

Remarks 1. Allowable rotational speed : $d_m n \leq 20000$ ($d_m n = (\text{bore diameter of bearing [mm]} + \text{outside diameter of bearing [mm]}) / 2 \times \text{rotational speed [mm]}$)

- Please do not wash with organic solvent and/or white kerosene which have the ability to remove fat.
- To ensure normal rotation of the bearing, apply a load of 1% or more of the basic dynamic load rating at use.
- The operating temperature range is $-15 \sim +80^\circ\text{C}$. Continuous operating temperature is $+60^\circ\text{C}$ or less.

Basic dynamic load rating C	Basic static load rating C_0
N	N
6 610	7 260
9 250	11 200
12 300	14 900
15 600	20 200
13 400	17 500
17 000	23 600
13 900	18 800
17 600	25 400
14 900	21 200
18 900	28 700
15 800	23 700
20 000	32 100
25 100	40 100
36 000	63 900
31 000	60 200
44 600	95 800

1N=0.102kgf=0.2248lbs.
1mm=0.03937inch

MACHINED TYPE NEEDLE ROLLER BEARINGS

Without Inner Ring



Shaft dia. 5 – 15mm

Shaft dia. mm	Identification number						Mass (Ref.) g
	RNA 49	RNA 69	RNA 48	TAF	TR	GTR	
5	—	—	—	TAF 51010	—	—	3.4
	RNA 493	—	—	TAF 51012	—	—	4.2 4.6
6	RNA 494	—	—	—	—	—	5.3 6.4
	—	—	—	TAF 61212	—	—	
7	RNA 495	—	—	—	—	—	5.9 6.9
	—	—	—	TAF 71410	—	—	8.3
8	—	—	—	TAF 71412	—	—	
	RNA 496	—	—	—	—	—	7.4 9.1 12.9
9	—	—	—	TAF 81512	—	—	
	—	—	—	TAF 81516	—	—	
10	—	—	—	TAF 91612	—	—	9.8 13.2
	RNA 497	—	—	TAF 91616	—	—	9.3
10	—	—	—	—	—	—	10.7 14.3
	RNA 498	—	—	TAF 101712	—	—	12.6
12	—	—	—	TAF 101716	—	—	
	—	—	—	TAF 121912	—	—	12.2 16.3
12	—	—	—	TAF 121916	—	—	13.6
	RNA 499	—	—	—	—	—	
14	—	—	—	—	—	—	16.5 21
	RNA 4900	—	—	TAF 142216	—	—	26.5
15	—	—	—	TAF 142220	—	—	
	—	—	—	TAF 152316	—	—	22.5 28
15	—	—	—	TAF 152320	—	—	

Notes⁽¹⁾ Minimum allowable value of chamfer dimension r
⁽²⁾ Allowable rotational speed applies to oil lubrication. For grease lubrication, a maximum of 60% of this value is allowable.

Remarks1. TAF series with a roller set bore diameter F_w of 26 mm or less have no oil hole. In others, the outer ring has an oil groove and an oil hole.

2. No grease is prepacked. Perform proper lubrication.

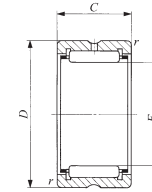

RNA49 TAF
RNA69 ($F_w \leq 35$)

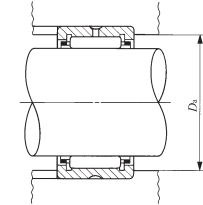

Boundary dimensions mm				Standard mounting dimension	Basic dynamic load rating	Basic static load rating	Allowable rotational speed ⁽²⁾ rpm
F_w	D	C	$r_{s \min}$ ⁽¹⁾	D_a Max. mm	C N	C_0 N	
5	10	10	0.2	8.4	2 420	1 950	80 000
5	10	12	0.2	8.4	3 080	2 660	80 000
5	11	10	0.15	9.8	2 420	1 950	80 000
6	12	10	0.15	10.8	2 700	2 320	70 000
6	12	12	0.2	10.4	3 440	3 170	70 000
7	13	10	0.15	11.8	2 960	2 690	60 000
7	14	10	0.2	12.4	3 600	2 960	60 000
7	14	12	0.2	12.4	4 610	4 050	60 000
8	15	10	0.15	13.8	3 960	3 420	50 000
8	15	12	0.2	13.4	5 060	4 690	50 000
8	15	16	0.2	13.4	7 080	7 220	50 000
9	16	12	0.2	14.4	5 490	5 330	45 000
9	16	16	0.2	14.4	7 680	8 210	45 000
9	17	10	0.15	15.8	4 530	3 650	45 000
10	17	12	0.2	15.4	5 880	5 970	40 000
10	17	16	0.2	15.4	8 230	9 190	40 000
10	19	11	0.2	17.4	6 180	5 030	40 000
12	19	12	0.3	17	6 610	7 260	35 000
12	19	16	0.3	17	9 250	11 200	35 000
12	20	11	0.3	18	6 600	6 310	35 000
14	22	13	0.3	20	9 230	10 100	30 000
14	22	16	0.3	20	11 700	13 700	30 000
14	22	20	0.3	20	14 800	18 600	30 000
15	23	16	0.3	21	12 300	14 900	30 000
15	23	20	0.3	21	15 600	20 200	30 000

1N=0.102kgf=0.2248lbs.
1mm=0.03937inch

MACHINED TYPE NEEDLE ROLLER BEARINGS

Without Inner Ring



Shaft dia. 16 – 22mm

Shaft dia. mm	Identification number						Mass (Ref.) g
	RNA 49	RNA 69	RNA 48	TAF	TR	GTR	
16	RNA 4901	—	—	—	—	—	18.1
	—	—	—	TAF 162416	—	—	23
	—	—	—	TAF 162420	—	—	29
	—	RNA 6901	—	—	—	—	30
17	—	—	—	TAF 172516	—	—	24.5
	—	—	—	TAF 172520	—	—	30.5
18	RNA 49/14	—	—	—	—	—	19.9
	—	—	—	TAF 182616	—	—	25.5
	—	—	—	TAF 182620	—	—	32
19	—	—	—	TAF 192716	—	—	27
	—	—	—	TAF 192720	—	—	34
20	RNA 4902	—	—	—	—	—	21.5
	—	—	—	TAF 202816	—	—	27.5
	—	—	—	TAF 202820	—	—	35.5
	—	RNA 6902	—	—	—	—	37
	—	—	—	—	TR 203320	—	59.5
	—	—	—	—	—	GTR 203320	69
21	—	—	—	TAF 212916	—	—	29
	—	—	—	TAF 212920	—	—	36
22	RNA 4903	—	—	—	—	—	23.5
	—	—	—	TAF 223016	—	—	30
	—	—	—	TAF 223020	—	—	37.5
	—	RNA 6903	—	—	—	—	40.5
	—	—	—	—	TR 223425	—	73.5
—	—	—	—	—	GTR 223425	87	

Notes⁽¹⁾ Minimum allowable value of chamfer dimension r

⁽²⁾ Allowable rotational speed applies to oil lubrication. For grease lubrication, a maximum of 60% of this value is allowable.

Remarks1. TAF series with a roller set bore diameter F_w of 26 mm or less have no oil hole. In others, the outer ring has an oil groove and an oil hole.

2. No grease is prepacked. Perform proper lubrication.

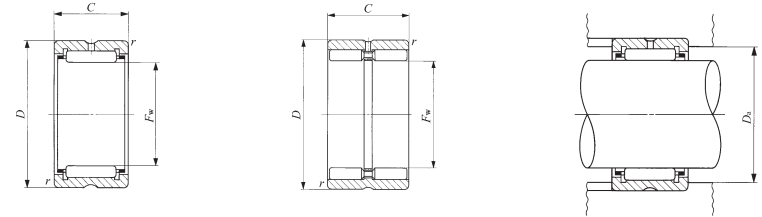

RNA49 TAF TR
RNA69 ($F_w \leq 35$)

GTR

Boundary dimensions mm				Standard mounting dimension D_a Max. mm	Basic dynamic load rating C N	Basic static load rating C_0 N	Allowable rotational speed ⁽²⁾ rpm
F_w	D	C	$r_{s \min}^{(1)}$				
16	24	13	0.3	22	9 600	11 100	25 000
16	24	16	0.3	22	12 300	15 100	25 000
16	24	20	0.3	22	15 500	20 400	25 000
16	24	22	0.3	22	17 100	23 000	25 000
17	25	16	0.3	23	12 900	16 300	25 000
17	25	20	0.3	23	16 300	22 000	25 000
18	26	13	0.3	24	10 600	12 800	20 000
18	26	16	0.3	24	13 400	17 500	20 000
18	26	20	0.3	24	17 000	23 600	20 000
19	27	16	0.3	25	14 000	18 700	20 000
19	27	20	0.3	25	17 700	25 300	20 000
20	28	13	0.3	26	10 900	13 800	20 000
20	28	16	0.3	26	13 900	18 800	20 000
20	28	20	0.3	26	17 600	25 400	20 000
20	28	23	0.3	26	19 300	28 800	20 000
20	33	20	0.3	31	24 300	26 500	20 000
20	33	20	0.3	31	29 200	37 200	7 500
21	29	16	0.3	27	14 400	20 000	19 000
21	29	20	0.3	27	18 200	27 100	19 000
22	30	13	0.3	28	11 700	15 600	18 000
22	30	16	0.3	28	14 900	21 200	18 000
22	30	20	0.3	28	18 900	28 700	18 000
22	30	23	0.3	28	20 800	32 500	18 000
22	34	25	0.3	32	29 100	36 800	18 000
22	34	25	0.3	32	37 900	57 800	7 000

1N=0.102kgf=0.2248lbs.

1mm=0.03937inch

MACHINED TYPE NEEDLE ROLLER BEARINGS

Without Inner Ring



Shaft dia. 24 – 30mm

Shaft dia. mm	Identification number						Mass (Ref.) g
	RNA 49	RNA 69	RNA 48	TAF	TR	GTR	
24	—	—	—	TAF 243216	—	—	32
	—	—	—	TAF 243220	—	—	40.5
25	—	—	—	TAF 253316	—	—	33.5
	RNA 4904	—	—	TAF 253320	—	—	42
		—	—	—	—	—	—
	—	RNA 6904	—	—	—	—	95.5
	—	—	—	—	TR 253820	—	71
	—	—	—	—	TR 253825	—	89
—	—	—	—	—	GTR 253820	81.5	
—	—	—	—	—	GTR 253825	104	
26	—	—	—	TAF 263416	—	—	34.5
	—	—	—	TAF 263420	—	—	43.5
28	—	—	—	TAF 283720	—	—	51.5
	RNA 49/22	—	—	TAF 283730	—	—	83.5
		—	—	—	—	—	—
	—	RNA 69/22	—	—	—	—	97.5
29	—	—	—	TAF 293820	—	—	57
	—	—	—	TAF 293830	—	—	85
30	—	—	—	TAF 304020	—	—	64.5
	RNA 4905	—	—	TAF 304030	—	—	97.5
		—	—	—	—	—	—
	—	RNA 6905	—	—	—	—	111
	—	—	—	—	TR 304425	—	115
	—	—	—	—	—	GTR 304425	133

Notes⁽¹⁾ Minimum allowable value of chamfer dimension r

⁽²⁾ Allowable rotational speed applies to oil lubrication. For grease lubrication, a maximum of 60% of this value is allowable.

Remarks1. TAF series with a roller set bore diameter F_w of 26 mm or less have no oil hole. In others, the outer ring has an oil groove and an oil hole.

2. No grease is prepacked. Perform proper lubrication.

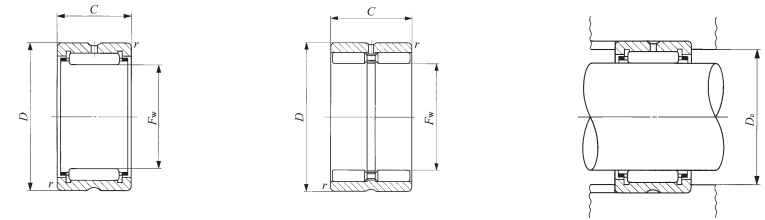

RNA49 TAF TR
RNA69 ($F_w \leq 35$)

GTR

F_w	Boundary dimensions mm			Standard mounting dimension D_a Max. mm	Basic dynamic load rating C N	Basic static load rating C_0 N	Allowable rotational speed ⁽²⁾ rpm
	D	C	$r_{s \min}$ ⁽¹⁾				
24	32	16	0.3	30	15 300	22 500	17 000
24	32	20	0.3	30	19 400	30 500	17 000
25	33	16	0.3	31	15 800	23 700	16 000
25	33	20	0.3	31	20 000	32 100	16 000
25	37	17	0.3	35	21 000	25 000	16 000
25	37	30	0.3	35	35 400	48 900	16 000
25	38	20	0.3	36	28 900	35 000	16 000
25	38	25	0.3	36	34 800	44 400	16 000
25	38	20	0.3	36	33 300	46 500	6 000
25	38	25	0.3	36	42 400	63 700	6 000
26	34	16	0.3	32	16 300	24 900	15 000
26	34	20	0.3	32	20 600	33 800	15 000
28	37	20	0.3	35	21 700	37 100	14 000
28	37	30	0.3	35	31 100	58 900	14 000
28	39	17	0.3	37	21 400	28 900	14 000
28	39	30	0.3	37	36 300	56 900	14 000
29	38	20	0.3	36	21 600	37 200	14 000
29	38	30	0.3	36	30 900	59 100	14 000
30	40	20	0.3	38	25 100	40 100	13 000
30	40	30	0.3	38	36 000	63 900	13 000
30	42	17	0.3	40	23 700	30 700	13 000
30	42	30	0.3	40	42 100	64 300	13 000
30	44	25	0.3	42	37 900	52 100	13 000
30	44	25	0.3	42	47 000	76 500	5 000

1N=0.102kgf=0.2248lbs.
1mm=0.03937inch

MACHINED TYPE NEEDLE ROLLER BEARINGS

Without Inner Ring



Shaft dia. 32 – 40mm

Shaft dia. mm	Identification number						Mass (Ref.) g
	RNA 49	RNA 69	RNA 48	TAF	TR	GTR	
32	—	—	—	TAF 324220	—	—	68
	—	—	—	TAF 324230	—	—	102
	RNA 49/28	—	—	—	—	—	76.5
	—	RNA 69/28	—	—	—	—	133
	—	—	—	—	—	GTR 324530	152
35	—	—	—	TAF 354520	—	—	73.5
	—	—	—	TAF 354530	—	—	112
	RNA 4906	—	—	—	—	—	72.5
	—	RNA 6906	—	—	—	—	125
	—	—	—	—	TR 354830	—	139
	—	—	—	—	—	GTR 354830	163
37	—	—	—	TAF 374720	—	—	77.5
	—	—	—	TAF 374730	—	—	117
38	—	—	—	TAF 384820	—	—	79
	—	—	—	TAF 384830	—	—	119
	—	—	—	—	TR 385230	—	168
	—	—	—	—	—	GTR 385230	195
40	—	—	—	TAF 405020	—	—	83
	—	—	—	TAF 405030	—	—	125
	RNA 49/32	—	—	—	—	—	96
	—	RNA 69/32	—	—	—	—	172
	—	—	—	—	TR 405520	—	129
	—	—	—	—	—	GTR 405520	144

Notes⁽¹⁾ Minimum allowable value of chamfer dimension r
⁽²⁾ Allowable rotational speed applies to oil lubrication. For grease lubrication, a maximum of 60% of this value is allowable.
 Remarks1. The outer ring has an oil groove and an oil hole.
 2. No grease is prepacked. Perform proper lubrication.

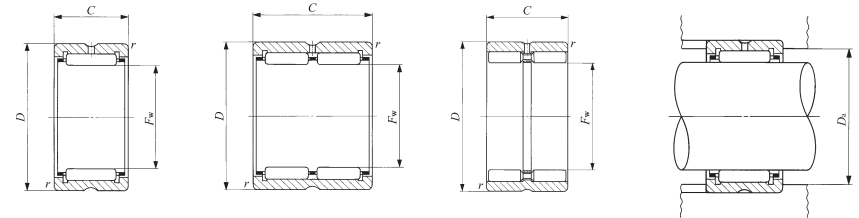

RNA49 TAF TR
RNA69 ($F_w \leq 35$)

RNA69

GTR

Boundary dimensions mm				Standard mounting dimension D_a Max. mm	Basic dynamic load rating C N	Basic static load rating C_0 N	Allowable rotational speed ⁽²⁾ rpm
F_w	D	C	$r_{s \min}^{(1)}$				
32	42	20	0.3	40	25 700	42 200	12 000
32	42	30	0.3	40	36 800	67 200	12 000
32	45	17	0.3	43	24 500	32 700	12 000
32	45	30	0.3	43	41 800	64 800	12 000
32	45	30	0.3	43	58 000	101 000	4 500
35	45	20	0.3	43	26 900	46 200	11 000
35	45	30	0.3	43	38 600	73 600	11 000
35	47	17	0.3	45	25 200	34 700	11 000
35	47	30	0.3	45	43 000	69 000	11 000
35	48	30	0.3	46	47 400	72 300	11 000
35	48	30	0.3	46	61 100	110 000	4 500
37	47	20	0.3	45	28 200	50 100	11 000
37	47	30	0.3	45	40 500	79 800	11 000
38	48	20	0.3	46	28 100	50 200	11 000
38	48	30	0.3	46	40 300	80 000	11 000
38	52	30	0.6	48	50 800	81 100	11 000
38	52	30	0.6	48	64 200	121 000	4 000
40	50	20	0.3	48	29 400	54 100	10 000
40	50	30	0.3	48	42 300	86 200	10 000
40	52	20	0.6	48	31 200	47 800	10 000
40	52	36	0.6	48	53 500	95 700	10 000
40	55	20	0.6	51	37 400	55 700	10 000
40	55	20	0.6	51	44 300	73 600	3 500

1N=0.102kgf=0.2248lbs.
1mm=0.03937inch

MACHINED TYPE NEEDLE ROLLER BEARINGS

Without Inner Ring



Shaft dia. 42 – 50mm

Shaft dia. mm	Identification number						Mass (Ref.) g
	RNA 49	RNA 69	RNA 48	TAF	TR	GTR	
42	—	—	—	TAF 425220	—	—	86.5
	—	—	—	TAF 425230	—	—	130
	RNA 4907	—	—	—	—	—	113
	—	RNA 6907	—	—	—	—	200
42	—	—	—	—	TR 425630	—	183
	—	—	—	—	—	GTR 425630	210
43	—	—	—	TAF 435320	—	—	88.5
	—	—	—	TAF 435330	—	—	133
45	—	—	—	TAF 455520	—	—	92
	—	—	—	TAF 455530	—	—	138
	RNA 49/38	—	—	—	—	—	120
	—	—	—	—	TR 455930	—	193
45	—	—	—	—	—	GTR 455930	225
	—	—	—	TAF 475720	—	—	95
47	—	—	—	TAF 475730	—	—	144
	—	—	—	—	—	—	—
48	RNA 4908	—	—	—	—	—	152
	—	—	—	—	TR 486230	—	205
	—	RNA 6908	—	—	—	—	275
	—	—	—	—	—	GTR 486230	240
50	—	—	—	TAF 506225	—	—	159
	—	—	—	TAF 506235	—	—	225
	—	—	—	—	TR 506430	—	210
	RNA 49/42	—	—	—	—	—	174
50	—	—	—	—	—	GTR 506430	245

- Notes⁽¹⁾ Minimum allowable value of chamfer dimension r
⁽²⁾ Allowable rotational speed applies to oil lubrication. For grease lubrication, a maximum of 60% of this value is allowable.
 Remarks1. The outer ring has an oil groove and an oil hole.
 2. No grease is prepacked. Perform proper lubrication.

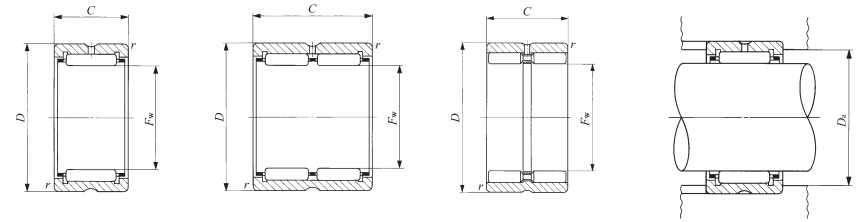

RNA49 TAF TR

RNA69

GTR

Boundary dimensions mm				Standard mounting dimension D_a Max. mm	Basic dynamic load rating C N	Basic static load rating C_0 N	Allowable rotational speed ⁽²⁾ rpm
F_w	D	C	$r_{s \min}^{(1)}$				
42	52	20	0.3	50	29 900	56 200	9 500
42	52	30	0.3	50	43 000	89 400	9 500
42	55	20	0.6	51	32 000	50 100	9 500
42	55	36	0.6	51	54 900	100 000	9 500
42	56	30	0.6	52	53 800	90 100	9 500
42	56	30	0.6	52	67 500	133 000	3 500
43	53	20	0.3	51	30 500	58 200	9 500
43	53	30	0.3	51	43 800	92 600	9 500
45	55	20	0.3	53	31 000	60 200	9 000
45	55	30	0.3	53	44 600	95 800	9 000
45	58	20	0.6	54	33 600	54 600	9 000
45	59	30	0.6	55	55 100	94 800	9 000
45	59	30	0.6	55	70 300	142 000	3 500
47	57	20	0.3	55	31 500	62 200	8 500
47	57	30	0.3	55	45 200	99 100	8 500
48	62	22	0.6	58	41 600	67 400	8 500
48	62	30	0.6	58	56 300	99 500	8 500
48	62	40	0.6	58	71 300	135 000	8 500
48	62	30	0.6	58	72 700	154 000	3 000
50	62	25	0.3	60	43 000	85 300	8 000
50	62	35	0.3	60	58 000	125 000	8 000
50	64	30	0.6	60	57 700	104 000	8 000
50	65	22	0.6	61	42 500	70 300	8 000
50	64	30	0.6	60	74 600	158 000	3 000

1N=0.102kgf=0.2248lbs.
 1mm=0.03937inch

MACHINED TYPE NEEDLE ROLLER BEARINGS

Without Inner Ring



Shaft dia. 52 – 68mm

Shaft dia. mm	Identification number						Mass (Ref.) g
	RNA 49	RNA 69	RNA 48	TAF	TR	GTR	
52	RNA 4909	—	—	—	—	—	197
	—	RNA 6909	—	—	—	—	355
55	—	—	—	TAF 556825	—	—	193
	RNA 49/48	—	—	TAF 556835	—	—	255
	—	—	—	—	—	—	188
58	RNA 4910	—	—	—	—	—	179
	—	RNA 6910	—	—	—	—	320
	—	—	—	—	TR 587745	—	515
60	—	—	—	TAF 607225	—	—	187
	RNA 49/52	—	—	TAF 607235	—	—	260
	—	—	—	—	—	—	205
62	—	—	—	—	TR 628138	—	460
	—	—	—	—	—	GTR 628138	520
63	RNA 4911	—	—	—	—	—	265
	—	RNA 6911	—	—	—	—	475
65	—	—	—	TAF 657825	—	—	225
	RNA 49/58	—	—	TAF 657835	—	—	315
	—	—	—	—	—	—	275
68	—	—	—	TAF 688225	—	—	250
	RNA 4912	—	—	TAF 688235	—	—	350
	—	—	—	—	—	—	285
	—	RNA 6912	—	—	—	—	510

Notes⁽¹⁾ Minimum allowable value of chamfer dimension r
⁽²⁾ Allowable rotational speed applies to oil lubrication. For grease lubrication, a maximum of 60% of this value is allowable.
 Remarks1. The outer ring has an oil groove and an oil hole.
 2. No grease is prepacked. Perform proper lubrication.

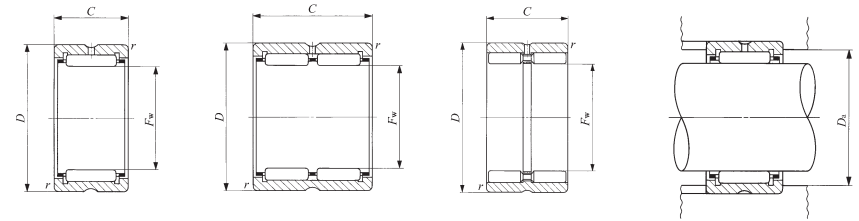

RNA49 TAF TR

RNA69

GTR

Boundary dimensions mm				Standard mounting dimension D_a Max. mm	Basic dynamic load rating C N	Basic static load rating C_0 N	Allowable rotational speed ⁽²⁾ rpm
F_w	D	C	$r_{s \min}^{(1)}$				
52	68	22	0.6	64	43 500	73 300	7 500
52	68	40	0.6	64	74 600	147 000	7 500
55	68	25	0.3	66	45 400	94 000	7 500
55	68	35	0.3	66	61 200	138 000	7 500
55	70	22	0.6	66	44 300	76 300	7 500
58	72	22	0.6	68	46 200	82 100	7 000
58	72	40	0.6	68	79 200	164 000	7 000
58	77	45	1	72	104 000	191 000	7 000
58	77	45	1	72	135 000	280 000	2 500
60	72	25	0.3	70	47 500	103 000	6 500
60	72	35	0.3	70	64 100	151 000	6 500
60	75	22	0.6	71	47 100	85 100	6 500
62	81	38	1	76	92 000	166 000	6 500
62	81	38	1	76	118 000	241 000	2 500
63	80	25	1	75	57 600	97 200	6 500
63	80	45	1	75	98 700	194 000	6 500
65	78	25	0.6	74	49 600	112 000	6 000
65	78	35	0.6	74	67 000	164 000	6 000
65	82	25	1	77	58 900	101 000	6 000
68	82	25	0.6	78	54 800	117 000	6 000
68	82	35	0.6	78	72 000	166 000	6 000
68	85	25	1	80	60 200	105 000	6 000
68	85	45	1	80	103 000	211 000	6 000

1N=0.102kgf=0.2248lbs.
 1mm=0.03937inch

MACHINED TYPE NEEDLE ROLLER BEARINGS

Without Inner Ring



Shaft dia. 70 – 85mm

Shaft dia. mm	Identification number						Mass (Ref.) g
	RNA 49	RNA 69	RNA 48	TAF	TR	GTR	
70	—	—	—	TAF 708525	—	—	280
	—	—	—	TAF 708535	—	—	395
	RNA 49/62	—	—	—	—	—	320
	—	—	—	—	TR 708945	—	605
72	—	—	—	—	—	GTR 708945	690
	RNA 4913	—	—	—	—	—	325
73	—	RNA 6913	—	—	—	—	585
	—	—	—	TAF 739025	—	—	335
75	—	—	—	TAF 739035	—	—	475
	—	—	—	TAF 759225	—	—	345
80	—	—	—	TAF 759235	—	—	485
	RNA 49/68	—	—	—	—	—	470
83	—	—	—	TAF 809525	—	—	315
	—	—	—	TAF 809535	—	—	445
85	RNA 4914	—	—	—	—	—	495
	—	RNA 6914	—	—	—	—	910
88	—	—	—	—	TR 8310845	—	995
	—	—	—	—	—	GTR 8310845	1 090
92	—	—	—	TAF 8510525	—	—	435
	—	—	—	TAF 8510535	—	—	525
95	RNA 4915	—	—	—	—	—	610
	—	RNA 6915	—	—	—	—	960

Notes⁽¹⁾ Minimum allowable value of chamfer dimension r
⁽²⁾ Allowable rotational speed applies to oil lubrication. For grease lubrication, a maximum of 60% of this value is allowable.
 Remarks1. The outer ring has an oil groove and an oil hole.
 2. No grease is prepacked. Perform proper lubrication.

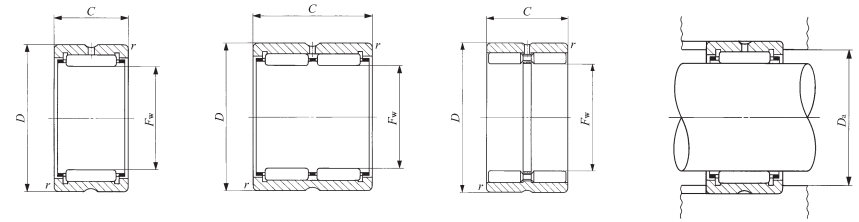

RNA49 TAF TR

RNA69

GTR

Boundary dimensions mm				Standard mounting dimension D_a Max. mm	Basic dynamic load rating C N	Basic static load rating C_0 N	Allowable rotational speed ⁽²⁾ rpm
F_w	D	C	$r_{s \min}^{(1)}$				
70	85	25	0.6	81	500	120 000	5 500
70	85	35	0.6	81	73 000	171 000	5 500
70	88	25	1	83	61 500	109 000	5 500
70			1		114 000	228 000	00
70			1		147 000	336 000	2 000
72	90	25	1		62 700	113 000	5 500
72	90	45	1		108 000	227 000	5 500
73	0	25	1		61 100	127 000	5 500
73	90	35	1		80 400	181 000	5 500
75	92	25	1	87	62 100	131 000	5 500
75	92	35	1	87	81 700	186 000	5 500
75	95	30	1	90	79 900	147 000	5 500
80	95	25	1	0	59 400	137 000	5 000
80	95	35	1	90	78 100	195 000	5 000
80	100	30	1	95	83 200	158 000	5 000
80	100	54	1	95	134 000	311 000	5 000
83	108	45	1	103	146 000	270 000	5 000
83	108	45	1	103	190 000	396 000	1 800
85	105	25	1	100	76 300	145 000	4 500
85	105	30	1	100	86 200	169 000	4 500
85	105	35	1	100	102 000	210 000	4 500
85	105	54	1	100	138 000	331 000	4 500

1N=0.102kgf=0.2248lbs.
 1mm=0.03937inch

MACHINED TYPE NEEDLE ROLLER BEARINGS

Without Inner Ring



Shaft dia. 90 – 105mm

Shaft dia. mm	Identification number						Mass (Ref.) g
	RNA 49	RNA 69	RNA 48	TAF	TR	GTR	
90	—	—	—	TAF 9011025	—	—	455
	RNA 4916	—	—	—	—	—	550
	—	—	—	TAF 9011035	—	—	640
	—	RNA 6916	—	—	—	—	1 010
93	—	—	—	—	TR 9311850	—	1 210
	—	—	—	—	—	GTR 9311850	1 340
95	—	—	—	TAF 9511526	—	—	495
	RNA 49/82	—	—	—	—	—	575
	—	—	—	TAF 9511536	—	—	690
	—	—	—	—	TR 9512045	—	1 120
100	—	—	—	—	—	—	1 230
	—	—	—	TAF 10012026	—	—	525
	RNA 4917	—	—	—	—	—	705
	—	—	—	TAF 10012036	—	—	725
105	—	—	—	—	—	—	1 300
	—	—	—	—	TR 10012550	—	1 290
	—	—	—	—	—	GTR 10012550	1 440
	RNA 4918	—	—	TAF 10512526	—	—	545
105	—	—	—	—	—	—	740
	—	—	—	TAF 10512536	—	—	760
	—	RNA 6918	—	—	—	—	1 360
	—	—	—	—	—	—	—

- Notes⁽¹⁾ Minimum allowable value of chamfer dimension r
⁽²⁾ Allowable rotational speed applies to oil lubrication. For grease lubrication, a maximum of 60% of this value is allowable.
 Remarks1. The outer ring has an oil groove and an oil hole.
 2. No grease is prepacked. Perform proper lubrication.

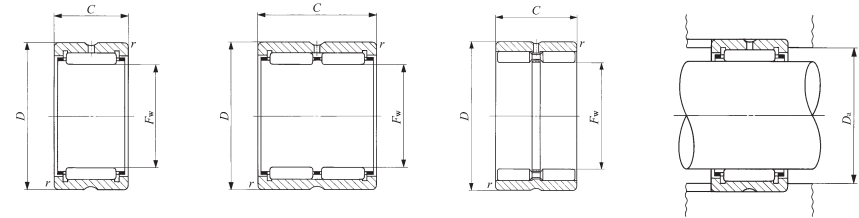

RNA49 TAF TR

RNA69

GTR

F_w	Boundary dimensions mm			Standard mounting dimension D_a Max. mm	Basic dynamic load rating C N	Basic static load rating C_0 N	Allowable rotational speed ⁽²⁾ rpm
	D	C	$r_{s \min}$ ⁽¹⁾				
90	110	25	1	105	77 300	150 000	4 500
90	110	30	1	105	87 300	175 000	4 500
90	110	35	1	105	103 000	217 000	4 500
90	110	54	1	105	143 000	351 000	4 500
93	118	50	1	113	165 000	329 000	4 500
93	118	50	1	113	224 000	509 000	1 600
95	115	26	1	110	79 700	159 000	4 000
95	115	30	1	110	90 000	186 000	4 000
95	115	36	1	110	106 000	231 000	4 000
95	120	45	1.5	112	155 000	305 000	4 000
95	120	45	1.5	112	204 000	455 000	1 600
100	120	26	1	115	82 400	168 000	4 000
100	120	35	1.1	113.5	110 000	244 000	4 000
100	120	36	1	115	110 000	244 000	4 000
100	120	63	1.1	113.5	173 000	467 000	4 000
100	125	50	1.5	117	172 000	355 000	4 000
100	125	50	1.5	117	234 000	549 000	1 500
105	125	26	1	120	84 700	178 000	4 000
105	125	35	1.1	118.5	113 000	258 000	4 000
105	125	36	1	120	113 000	258 000	4 000
105	125	63	1.1	118.5	178 000	490 000	4 000

1N=0.102kgf=0.2248lbs.
 1mm=0.03937inch

MACHINED TYPE NEEDLE ROLLER BEARINGS

Without Inner Ring



Shaft dia. 110 – 170mm

Shaft dia. mm	Identification number						Mass (Ref.) g
	RNA 49	RNA 69	RNA 48	TAF	TR	GTR	
110	—	—	—	TAF 11013030	—	—	660
	RNA 4919	—	—	—	—	—	770
	—	—	—	TAF 11013040	—	—	880
	—	RNA 6919	—	—	—	—	1 420
115	—	—	—	—	TR 11013550	—	1 400
	—	—	—	—	—	GTR 11013550	1 560
115	RNA 4920	—	—	—	—	—	1 190
	—	—	—	—	TR 11515350	—	2 350
120	—	—	RNA 4822	—	—	—	790
	—	—	—	—	—	—	1 280
125	RNA 4922	—	—	—	—	—	850
130	—	—	RNA 4824	—	—	—	1 930
135	RNA 4924	—	—	—	—	—	3 320
140	—	—	—	—	TR 14017860	—	3 730
	—	—	—	—	—	GTR 14017860	3 320
145	—	—	RNA 4826	—	—	—	1 100
150	RNA 4926	—	—	—	—	—	2 360
	—	—	—	—	TR 15018860	—	3 540
	—	—	—	—	—	GTR 15018860	3 970
155	—	—	RNA 4828	—	—	—	1 170
160	RNA 4928	—	—	—	—	—	2 500
165	—	—	RNA 4830	—	—	—	1 750
170	RNA 4930	—	—	—	—	—	4 090

Notes⁽¹⁾ Minimum allowable value of chamfer dimension r
⁽²⁾ Allowable rotational speed applies to oil lubrication. For grease lubrication, a maximum of 60% of this value is allowable.
 Remarks1. The outer ring has an oil groove and an oil hole.
 2. No grease is prepacked. Perform proper lubrication.

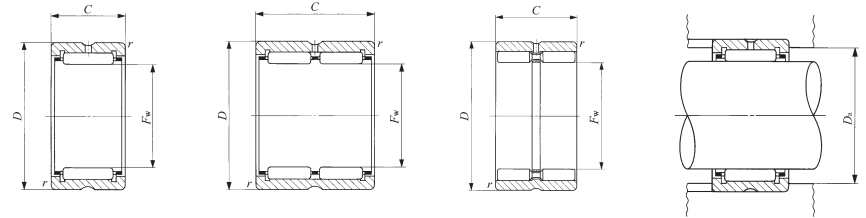

RNA49 RNA48
TAF TR

RNA69

GTR

Boundary dimensions mm				Standard mounting dimension	Basic dynamic load rating	Basic static load rating	Allowable rotational speed ⁽²⁾
F_w	D	C	$r_{s \min}^{(1)}$	D_a Max. mm	C N	C_0 N	rpm
110	130	30	1	125	106 000	240 000	3 500
110	130	35	1.1	123.5	116 000	271 000	3 500
110	130	40	1	125	134 000	324 000	3 500
110	130	63	1.1	123.5	182 000	514 000	3 500
110	135	50	1.5	127	183 000	395 000	3 500
110	135	50	1.5	127	245 000	603 000	1 400
115	140	40	1.1	133.5	145 000	329 000	3 500
115	153	50	1.5	145	233 000	414 000	3 500
115	153	50	1.5	145	315 000	614 000	1 300
120	140	30	1	135	93 200	239 000	3 500
125	150	40	1.1	143.5	152 000	357 000	3 000
130	150	30	1	145	96 900	259 000	3 000
135	165	45	1.1	158.5	187 000	435 000	3 000
140	178	60	1.5	170	307 000	625 000	3 000
140	178	60	1.5	170	409 000	923 000	1 100
145	165	35	1.1	158.5	116 000	340 000	3 000
150	180	50	1.5	172	215 000	540 000	2 500
150	188	60	1.5	180	320 000	675 000	2 500
150	188	60	1.5	180	423 000	989 000	1 000
155	175	35	1.1	168.5	120 000	363 000	2 500
160	190	50	1.5	182	224 000	580 000	2 500
165	190	40	1.1	183.5	168 000	446 000	2 500
170	210	60	2	201	324 000	712 000	2 500

1N=0.102kgf=0.2248lbs.
1mm=0.03937inch

MACHINED TYPE NEEDLE ROLLER BEARINGS

Without Inner Ring



Shaft dia. 175 – 350mm

Shaft dia. mm	Identification number						Mass (Ref.) g
	RNA 49	RNA 69	RNA 48	TAF	TR	GTR	
175	—	—	RNA 4832	—	—	—	1 850
180	RNA 4932	—	—	—	—	—	4 310
185	—	—	RNA 4834	—	—	—	2 700
190	RNA 4934	—	—	—	—	—	4 530
195	—	—	RNA 4836	—	—	—	2 840
205	RNA 4936	—	—	—	—	—	6 250
210	—	—	RNA 4838	—	—	—	3 380
215	RNA 4938	—	—	—	—	—	6 500
220	—	—	RNA 4840	—	—	—	3 520
225	RNA 4940	—	—	—	—	—	10 400
240	—	—	RNA 4844	—	—	—	3 820
245	RNA 4944	—	—	—	—	—	11 200
265	—	—	RNA 4848	—	—	—	5 670
	RNA 4948	—	—	—	—	—	12 000
285	—	—	RNA 4852	—	—	—	6 070
290	RNA 4952	—	—	—	—	—	21 200
305	—	—	RNA 4856	—	—	—	9 750
310	RNA 4956	—	—	—	—	—	22 500
330	—	—	RNA 4860	—	—	—	13 200
340	RNA 4960	—	—	—	—	—	33 400
350	—	—	RNA 4864	—	—	—	14 100

Notes⁽¹⁾ Minimum allowable value of chamfer dimension r

⁽²⁾ Allowable rotational speed applies to oil lubrication. For grease lubrication, a maximum of 60% of this value is allowable.

Remarks1. The outer ring has an oil groove and an oil hole.
2. No grease is prepacked. Perform proper lubrication.

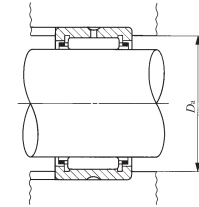
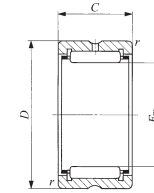

RNA49 RNA48

Boundary dimensions mm				Standard mounting dimension D_a Max. mm	Basic dynamic load rating C N	Basic static load rating C_0 N	Allowable rotational speed ⁽²⁾ rpm
F_w	D	C	$r_{s \min}$ ⁽¹⁾				
175	200	40	1.1	193.5	173 000	474 000	2 500
180	220	60	2	211	337 000	761 000	1 900
185	215	45	1.1	208.5	211 000	567 000	1 900
190	230	60	2	221	347 000	810 000	1 900
195	225	45	1.1	218.5	218 000	602 000	1 900
205	250	69	2	241	434 000	989 000	1 900
210	240	50	1.5	232	249 000	726 000	1 800
215	260	69	2	251	440 000	1 020 000	1 700
220	250	50	1.5	242	255 000	766 000	1 600
225	280	80	2.1	269	518 000	1 120 000	1 600
240	270	50	1.5	262	266 000	833 000	1 500
245	300	80	2.1	289	536 000	1 200 000	1 400
265	300	60	2	291	345 000	1 150 000	1 300
265	320	80	2.1	309	565 000	1 320 000	1 300
285	320	60	2	311	354 000	1 220 000	1 100
290	360	100	2.1	349	847 000	1 900 000	1 100
305	350	69	2	341	486 000	1 550 000	950
310	380	100	2.1	369	877 000	2 040 000	950
330	380	80	2.1	369	610 000	1 900 000	900
340	420	118	3	407	1 130 000	2 650 000	850
350	400	80	2.1	389	635 000	2 040 000	750

1N=0.102kgf=0.2248lbs.
1mm=0.03937inch

MACHINED TYPE NEEDLE ROLLER BEARINGS

Without Inner Ring



Shaft dia. 360 – 490mm

Shaft dia. mm	Identification number						Ma (Ref.) g
	RNA 49	RNA 69	RNA 48	TAF	TR	GTR	
360	RNA 4964	—	—	—	—	—	35 200
370	—	—	RNA 4868	—	—	—	14 800
380	RNA 4968	—	—	—	—	—	37 000
390	—	—	RNA 4872	—	—	—	15 600
400	RNA 4972	—	—	—	—	—	38 700
415	—	—	RNA 4876	—	—	—	27 900
430	RNA 4976	—	—	—	—	—	56 400
450	RNA 4980	—	—	—	—	—	58 800
470	RNA 4984	—	—	—	—	—	61 200
490	RNA 4988	—	—	—	—	—	86 900

- Notes⁽¹⁾ Minimum allowable value of chamfer dimension r
⁽²⁾ Allowable rotational speed applies to oil lubrication. For grease lubrication, a maximum of 60% of this value is allowable.
 Remarks1. The outer ring has an oil groove and an oil hole.
 2. No grease is prepacked. Perform proper lubrication.

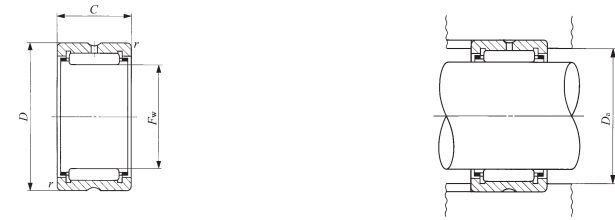

RNA49 RNA48

w	Boundary dimensions			Standard mounting dimension D_a Max. mm	Basic dynamic load rating C N	Basic static load rating C_0 N	Allowable rotational speed ⁽²⁾ rpm
	D	C	$r_{s \min}$ ⁽¹⁾				
360	440	118	3	427	70 000	2 830 000	750
370	420	80	2.1	409	651 000	2 140 000	700
380	460	118	3	447	220 000	3 020 000	700
390	440	80	2.1	429	680 000	2 320 000	650
400	480	118	3	467	260 000	3 200 000	600
415	480	100	2.1	469	951 000	2 860 000	600
430	520	140	4	504	540 000	4 030 000	500
450	540	140	4	524	590 000	4 270 000	500
470	560	140	4	544	640 000	4 510 000	500
490	600	160	4	584	910 000	5 140 000	400

N=0.102kgf=0.2248lb .
 mm=0.03937inch

MACHINED TYPE NEEDLE ROLLER BEARINGS

With Inner Ring



Shaft dia. 5 – 12mm

Shaft dia. mm	Identification number						Mass (Ref.) g	<i>d</i>
	NA 49	NA 69	NA 48	TAFI	TRI	GTRI		
5	NA 495	—	—	—	—	—	7.3	5
	—	—	—	TAFI 51512	—	—	11.9	5
	—	—	—	TAFI 51516	—	—	16.7	5
6	NA 496	—	—	—	—	—	9.1	6
	—	—	—	TAFI 61612	—	—	13	6
	—	—	—	TAFI 61616	—	—	17.5	6
7	NA 497	—	—	—	—	—	11.2	7
	—	—	—	TAFI 71712	—	—	14.3	7
	—	—	—	TAFI 71716	—	—	19.2	7
8	NA 498	—	—	—	—	—	15	8
9	—	—	—	TAFI 91912	—	—	16.7	9
	—	—	—	TAFI 91916	—	—	22.5	9
	NA 499	—	—	—	—	—	16.7	9
10	NA 4900	—	—	—	—	—	24	10
	—	—	—	TAFI 102216	—	—	30	10
	—	—	—	TAFI 102220	—	—	38	10
12	NA 4901	—	—	—	—	—	26.5	12
	—	—	—	TAFI 122416	—	—	33.5	12
	—	—	—	TAFI 122420	—	—	42.5	12
	—	NA 6901	—	—	—	—	44.5	12

Notes⁽¹⁾ Minimum allowable value of chamfer dimension *r*
⁽²⁾ Allowable axial shift amount of inner ring to outer ring
⁽³⁾ Allowable rotational speed applies to oil lubrication. For grease lubrication, a maximum of 60% of this value is allowable.
 Remarks1. TAFI series with a bore diameter *d* of 22 mm or less have no oil hole. In others, the outer ring has an oil groove and an oil hole.
 2. No grease is prepacked. Perform proper lubrication.

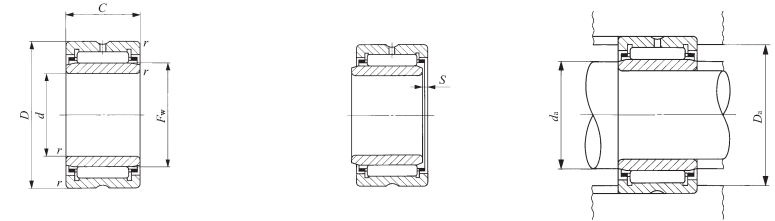

NA49 TAFI
NA69 (*d* ≤ 30)

Boundary dimensions mm						Standard mounting dimensions mm			Basic dynamic load rating <i>C</i> N	Basic static load rating <i>C</i> ₀ N	Allowable rotational speed ⁽³⁾ rpm	Assembled inner ring
<i>D</i>	<i>C</i>	<i>B</i>	<i>r</i> _{s min} ⁽¹⁾	<i>F</i> _w	<i>S</i> ⁽²⁾	Min. <i>d</i> _a	Max. <i>D</i> _a	<i>D</i> _a Max.				
13	10	—	0.15	7	0.5	6.2	6.7	11.8	2 960	2 690	60 000	LRT 5710
15	12	—	0.2	8	0.5	6.6	7.7	13.4	5 060	4 690	50 000	LRT 5812
15	16	—	0.2	8	0.5	6.6	7.7	13.4	7 080	7 220	50 000	LRT 5816
15	10	—	0.15	8	0.5	7.2	7.7	13.8	3 960	3 420	50 000	LRT 6810
16	12	—	0.2	9	0.5	7.6	8.7	14.4	5 490	5 330	45 000	LRT 6912
16	16	—	0.2	9	0.5	7.6	8.7	14.4	7 680	8 210	45 000	LRT 6916
17	10	—	0.15	9	0.5	8.2	8.7	15.8	4 530	3 650	45 000	LRT 7910
17	12	—	0.2	10	0.5	8.6	9.7	15.4	5 880	5 970	40 000	LRT 71012
17	16	—	0.2	10	0.5	8.6	9.7	15.4	8 230	9 190	40 000	LRT 71016
19	11	—	0.2	10	0.5	9.6	9.9	17.4	6 180	5 030	40 000	LRT 81011
19	12	—	0.3	12	0.5	11	11.5	17	6 610	7 260	35 000	LRT 91212
19	16	—	0.3	12	0.5	11	11.5	17	9 250	11 200	35 000	LRT 91216
20	11	—	0.3	12	0.5	11	11.5	18	6 600	6 310	35 000	LRT 91211
22	13	—	0.3	14	0.5	12	13	20	9 230	10 100	30 000	LRT 101413
22	16	—	0.3	14	0.5	12	13	20	11 700	13 700	30 000	LRT 101416
22	20	—	0.3	14	0.5	12	13	20	14 800	18 600	30 000	LRT 101420
24	13	—	0.3	16	0.5	14	15	22	9 660	11 100	25 000	LRT 121613
24	16	—	0.3	16	0.5	14	15	22	12 300	15 100	25 000	LRT 121616
24	20	—	0.3	16	0.5	14	15	22	15 500	20 400	25 000	LRT 121620
24	22	—	0.3	16	0.5	14	15	22	17 100	23 000	25 000	LRT 121622

1N=0.102kgf=0.2248lbs.
1mm=0.03937inch

MACHINED TYPE NEEDLE ROLLER BEARINGS

With Inner Ring

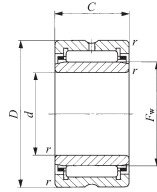

NA49 TAFI
NA69 ($d \leq 30$)

Shaft dia. 15 – 22mm

Shaft dia. mm	Identification number						Mass (Ref.)	d
	NA 49	NA 69	NA 48	TAFI	TRI	GTRI	g	
15	—	—	—	TAFI 152716	—	—	39.5	15
	NA 4902	—	—	TAFI 152720	—	—	50	15
	—	NA 6902	—	—	—	—	35	15
	—	—	—	—	—	—	61	15
17	—	—	—	—	TRI 153320	—	81	15
	—	—	—	—	—	GTRI 153320	90.5	15
	NA 4903	—	—	TAFI 172916	—	—	43.5	17
	—	NA 6903	—	TAFI 172920	—	—	54	17
20	—	—	—	—	—	—	39	17
	—	—	—	—	—	—	67	17
	—	—	—	—	TRI 173425	—	104	17
	—	—	—	—	—	GTRI 173425	117	17
22	NA 4904	—	—	TAFI 203216	—	—	48.5	20
	—	NA 6904	—	TAFI 203220	—	—	61	20
	—	—	—	—	—	—	78.5	20
	—	—	—	—	—	—	136	20
22	—	—	—	—	TRI 203820	—	99	20
	—	—	—	—	TRI 203825	—	124	20
	—	—	—	—	—	GTRI 203820	110	20
	—	—	—	—	—	GTRI 203825	138	20
22	NA 49/22	—	—	TAFI 223416	—	—	52	22
	—	—	—	TAFI 223420	—	—	67.5	22
	—	NA 69/22	—	—	—	—	87	22
	—	—	—	—	—	—	152	22

Notes⁽¹⁾ Minimum allowable value of chamfer dimension r
⁽²⁾ Allowable axial shift amount of inner ring to outer ring
⁽³⁾ Allowable rotational speed applies to oil lubrication. For grease lubrication, a maximum of 60% of this value is allowable.
 Remarks1. TAFI series with a bore diameter d of 22 mm or less have no oil hole. In others, the outer ring has an oil groove and an oil hole.
 2. No grease is prepacked. Perform proper lubrication.

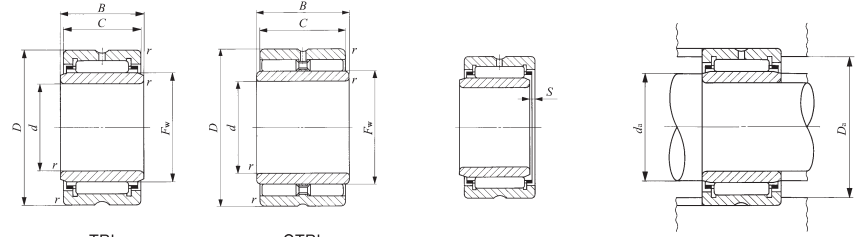

TRI

GTRI

Boundary dimensions mm						Standard mounting dimensions mm			Basic dynamic load rating	Basic static load rating	Allowable rotational speed ⁽³⁾	Assembled inner ring
D	C	B	$r_{s \min}$ ⁽¹⁾	F_w	S ⁽²⁾	Min.	d_a Max.	D_a Max.	C	C_0	rpm	
27	16	—	0.3	19	0.5	17	18	25	14 000	18 700	20 000	LRT 151916
27	20	—	0.3	19	0.5	17	18	25	17 700	25 300	20 000	LRT 151920
28	13	—	0.3	20	0.3	17	19	26	10 900	13 800	20 000	LRT 152013
28	23	—	0.3	20	0.3	17	19	26	19 300	28 800	20 000	LRT 152023
33	20	20.5	0.3	20	0.3	17	19	31	24 300	26 500	20 000	LRT 152020
33	20	20.5	0.3	20	—	17	19	31	29 200	37 200	7 500	LRTZ 152020
29	16	—	0.3	21	0.5	19	20	27	14 400	20 000	19 000	LRT 172116
29	20	—	0.3	21	0.5	19	20	27	18 200	27 100	19 000	LRT 172120
30	13	—	0.3	22	0.3	19	21	28	11 700	15 600	18 000	LRT 172213
30	23	—	0.3	22	0.3	19	21	28	20 800	32 500	18 000	LRT 172223
34	25	25.5	0.3	22	0.5	19	21	32	29 100	36 800	18 000	LRT 172225
34	25	25.5	0.3	22	—	19	21	32	37 900	57 800	7 000	LRTZ 172225
32	16	—	0.3	24	0.5	22	23	30	15 300	22 500	17 000	LRT 202416
32	20	—	0.3	24	0.5	22	23	30	19 400	30 500	17 000	LRT 202420
37	17	—	0.3	25	0.5	22	24	35	21 000	25 000	16 000	LRT 202517
37	30	—	0.3	25	0.5	22	24	35	35 400	48 900	16 000	LRT 202530
38	20	20.5	0.3	25	0.3	22	24	36	28 900	35 000	16 000	LRT 202520
38	25	25.5	0.3	25	0.5	22	24	36	34 800	44 400	16 000	LRT 202525
38	20	20.5	0.3	25	—	22	24	36	33 300	46 500	6 000	LRTZ 202520
38	25	25.5	0.3	25	—	22	24	36	42 400	63 700	6 000	LRTZ 202525
34	16	—	0.3	26	0.5	24	25	32	16 300	24 900	15 000	LRT 222616
34	20	—	0.3	26	0.5	24	25	32	20 600	33 800	15 000	LRT 222620
39	17	—	0.3	28	1	24	27	37	21 400	28 900	14 000	LRT 222817
39	30	—	0.3	28	0.5	24	27	37	36 300	56 900	14 000	LRT 222830

1N=0.102kgf=0.2248lbs.
1mm=0.03937inch

MACHINED TYPE NEEDLE ROLLER BEARINGS

With Inner Ring

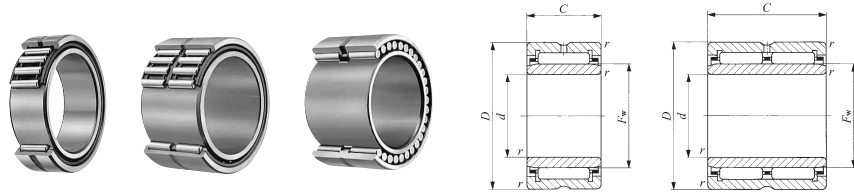

NA49 TAFI
NA69 ($d \leq 30$)

NA69

Shaft dia. 25 – 32mm

Shaft dia. mm	Identification number						Mass (Ref.) g	
	NA 49	NA 69	NA 48	TAFI	TRI	GTRI	d	d
25	—	—	—	TAFI 253820	—	—	82	25
	NA 4905	—	—	TAFI 253830	—	—	123	25
	—	NA 6905	—	—	—	—	92.5	25
	—	—	—	—	—	—	160	25
28	—	—	—	—	TRI 254425	—	157	25
	—	—	—	—	—	GTRI 254425	175	25
	NA 49/28	—	—	TAFI 284220	—	—	96.5	28
	—	NA 69/28	—	TAFI 284230	—	—	145	28
30	—	—	—	—	—	—	101	28
	—	—	—	—	—	—	176	28
	—	—	—	—	—	GTRI 284530	196	28
	—	—	—	—	—	—	—	—
30	—	—	—	TAFI 304520	—	—	112	30
	NA 4906	—	—	TAFI 304530	—	—	171	30
	—	NA 6906	—	—	—	—	106	30
	—	—	—	—	—	—	184	30
32	—	—	—	—	TRI 304830	—	199	30
	—	—	—	—	—	GTRI 304830	225	30
	NA 49/32	—	—	TAFI 324720	—	—	121	32
	—	—	—	TAFI 324730	—	—	180	32
32	—	—	—	—	—	—	165	32
	—	—	—	—	TRI 325230	—	245	32
	—	NA 69/32	—	—	—	—	295	32
	—	—	—	—	—	GTRI 325230	270	32

Notes⁽¹⁾ Minimum allowable value of chamfer dimension r
⁽²⁾ Allowable axial shift amount of inner ring to outer ring
⁽³⁾ Allowable rotational speed applies to oil lubrication. For grease lubrication, a maximum of 60% of this value is allowable.
 Remarks1. The outer ring has an oil groove and an oil hole.
 2. No grease is prepacked. Perform proper lubrication.

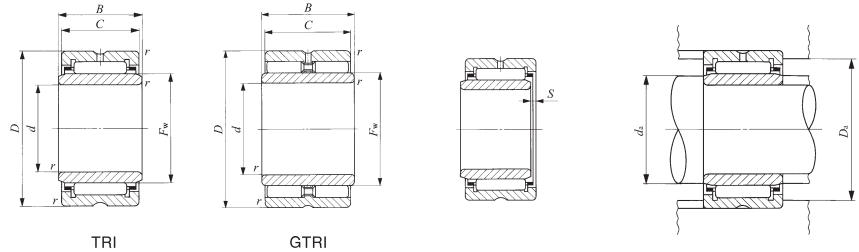

TRI

GTRI

Boundary dimensions mm							Standard mounting dimensions mm			Basic dynamic load rating	Basic static load rating	Allowable rotational speed ⁽³⁾	Assembled inner ring
D	C	B	$r_{s \min}^{(1)}$	F_w	$S^{(2)}$	d_a	Min.	Max.	D_a Max.	C	C_0	rpm	
38	20	—	0.3	29	0.5	27	28	36	21 600	37 200	14 000	LRT 252920	
38	30	—	0.3	29	1	27	28	36	30 900	59 100	14 000	LRT 252930	
42	17	—	0.3	30	0.5	27	29	40	23 700	30 700	13 000	LRT 253017	
42	30	—	0.3	30	0.5	27	29	40	42 100	64 300	13 000	LRT 253030	
44	25	25.5	0.3	30	0.5	27	29	42	37 900	52 100	13 000	LRT 253025	
44	25	25.5	0.3	30	—	27	29	42	47 000	76 500	5 000	LRTZ 253025	
42	20	—	0.3	32	0.5	30	31	40	25 700	42 200	12 000	LRT 283220	
42	30	—	0.3	32	1	30	31	40	36 800	67 200	12 000	LRT 283230	
45	17	—	0.3	32	1	30	31	43	24 500	32 700	12 000	LRT 283217	
45	30	—	0.3	32	1	30	31	43	41 800	64 800	12 000	LRT 283230	
45	30	30.5	0.3	32	—	30	31	43	58 000	101 000	4 500	LRTZ 283230	
45	20	—	0.3	35	0.3	32	34	43	26 900	46 200	11 000	LRT 303520	
45	30	—	0.3	35	0.5	32	34	43	38 600	73 600	11 000	LRT 303530	
47	17	—	0.3	35	0.5	32	34	45	25 200	34 700	11 000	LRT 303517	
47	30	—	0.3	35	0.5	32	34	45	43 000	69 000	11 000	LRT 303530	
48	30	30.5	0.3	35	1	32	34	46	47 400	72 300	11 000	LRT 303530-1	
48	30	30.5	0.3	35	—	32	34	46	61 100	110 000	4 500	LRTZ 303530	
47	20	—	0.3	37	0.3	34	36	45	28 200	50 100	11 000	LRT 323720	
47	30	—	0.3	37	0.5	34	36	45	40 500	79 800	11 000	LRT 323730	
52	20	—	0.6	40	0.5	36	39	48	31 200	47 800	10 000	LRT 324020	
52	30	30.5	0.6	38	0.5	36	37	48	50 800	81 100	11 000	LRT 323830	
52	36	—	0.6	40	0.3	36	39	48	53 500	95 700	10 000	LRT 324036	
52	30	30.5	0.6	38	—	36	37	48	64 200	121 000	4 000	LRTZ 323830	

1N=0.102kgf=0.2248lbs.
1mm=0.03937inch

MACHINED TYPE NEEDLE ROLLER BEARINGS

With Inner Ring

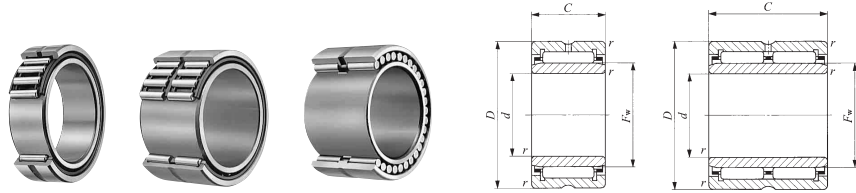

NA49 TAFI

NA69

Shaft dia. 35 – 45mm

Shaft dia. mm	Identification number						Mass (Ref.)		
	NA 49	NA 69	NA 48	TAFI	TRI	GTRI	g	d	
35	—	—	—	TAFI 355020	—	—	129	35	
	NA 4907	—	—	TAFI 355030	—	—	192	35	
		—	NA 6907	—	—	—	—	178	35
	—	—	—	—	—	—	320	35	
	—	—	—	—	TRI 355630	—	280	35	
	—	—	—	—	—	GTRI 355520	191	35	
—	—	—	—	—	GTRI 355630	310	35		
38	—	—	—	TAFI 385320	—	—	136	38	
	—	—	—	TAFI 385330	—	—	205	38	
40	—	—	—	TAFI 405520	—	—	143	40	
	—	—	—	TAFI 405530	—	—	215	40	
	NA 4908	—	—	—	—	TRI 405930	—	270	40
		—	NA 6908	—	—	—	—	245	40
	—	—	—	—	—	GTRI 405930	440	40	
	—	—	—	—	—	—	300	40	
42	—	—	—	TAFI 425720	—	—	149	42	
	—	—	—	TAFI 425730	—	—	225	42	
	—	—	—	—	TRI 426230	—	305	42	
	—	—	—	—	—	GTRI 426230	340	42	
45	—	—	—	TAFI 456225	—	—	230	45	
	—	—	—	TAFI 456235	—	—	320	45	
	NA 4909	—	—	—	—	TRI 456430	—	300	45
		—	NA 6909	—	—	—	—	285	45
	—	—	—	—	—	—	520	45	
	—	—	—	—	—	GTRI 456430	335	45	

- Notes⁽¹⁾ Minimum allowable value of chamfer dimension *r*
⁽²⁾ Allowable axial shift amount of inner ring to outer ring
⁽³⁾ Allowable rotational speed applies to oil lubrication. For grease lubrication, a maximum of 60% of this value is allowable.
 Remarks1. The outer ring has an oil groove and an oil hole.
 2. No grease is prepacked. Perform proper lubrication.

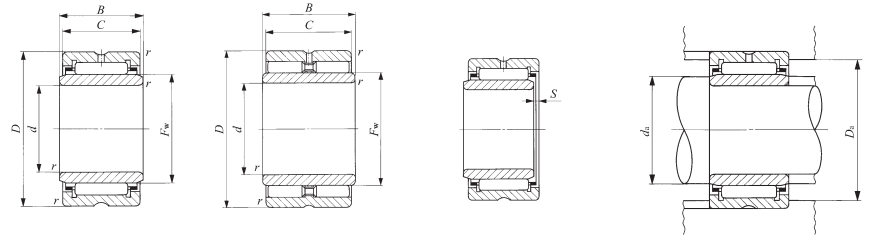

TRI

GTRI

Boundary dimensions mm						Standard mounting dimensions mm			Basic dynamic load rating <i>C</i>	Basic static load rating <i>C₀</i>	Allowable rotational speed ⁽³⁾ rpm	Assembled inner ring
<i>D</i>	<i>C</i>	<i>B</i>	<i>r_{s min}</i> ⁽¹⁾	<i>F_w</i>	<i>S</i> ⁽²⁾	Min. <i>d_a</i>	Max. <i>d_a</i>	<i>D_a</i> Max.				
50	20	—	0.3	40	0.3	37	39	48	29 400	54 100	10 000	LRT 354020
50	30	—	0.3	40	0.5	37	39	48	42 300	86 200	10 000	LRT 354030
55	20	—	0.6	42	0.5	39	41	51	32 000	50 100	9 500	LRT 354220
55	36	—	0.6	42	0.3	39	41	51	54 900	100 000	9 500	LRT 354236
56	30	30.5	0.6	42	0.5	39	41	52	53 800	90 100	9 500	LRT 354230
55	20	20.5	0.6	40	—	39	39.5	51	44 300	73 600	3 500	LRT 354020
56	30	30.5	0.6	42	—	39	41	52	67 500	133 000	3 500	LRTZ 354230
53	20	—	0.3	43	0.3	40	42	51	30 500	58 200	9 500	LRT 384320
53	30	—	0.3	43	0.5	40	42	51	43 800	92 600	9 500	LRT 384330
55	20	—	0.3	45	0.3	42	44	53	31 000	60 200	9 000	LRT 404520
55	30	—	0.3	45	0.5	42	44	53	44 600	95 800	9 000	LRT 404530
59	30	30.5	0.6	45	1	44	44.5	55	55 100	94 800	9 000	LRT 404530-1
62	22	—	0.6	48	0.5	44	47	58	41 600	67 400	8 500	LRT 404822
62	40	—	0.6	48	0.3	44	47	58	71 300	135 000	8 500	LRT 404840
59	30	30.5	0.6	45	—	44	44.5	55	70 300	142 000	3 500	LRTZ 404530
57	20	—	0.3	47	0.3	44	46	55	31 500	62 200	8 500	LRT 424720
57	30	—	0.3	47	0.5	44	46	55	45 200	99 100	8 500	LRT 424730
62	30	30.5	0.6	48	0.5	46	47	58	56 300	99 500	8 500	LRT 424830
62	30	30.5	0.6	48	—	46	47	58	72 700	154 000	3 000	LRTZ 424830
62	25	—	0.3	50	0.5	47	49	60	43 000	85 300	8 000	LRT 455025
62	35	—	0.3	50	1	47	49	60	58 000	125 000	8 000	LRT 455035
64	30	30.5	0.6	50	1	49	49.5	60	57 700	104 000	8 000	LRT 455030
68	22	—	0.6	52	0.5	49	51	64	43 500	73 300	7 500	LRT 455222
68	40	—	0.6	52	0.3	49	51	64	74 600	147 000	7 500	LRT 455240
64	30	30.5	0.6	50	—	49	49.5	60	74 600	158 000	3 000	LRTZ 455030

1N=0.102kgf=0.2248lbs.
 1mm=0.03937inch

MACHINED TYPE NEEDLE ROLLER BEARINGS

With Inner Ring

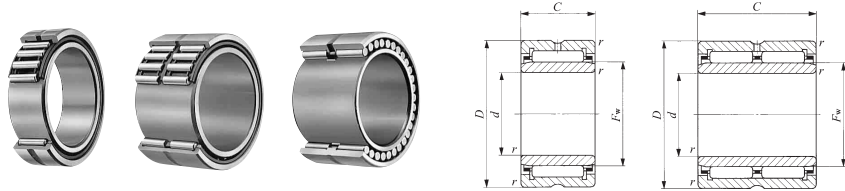

NA49 TAFI

NA69

Shaft dia. 50 – 70mm

Shaft dia. mm	Identification number						Mass (Ref.)	
	NA 49	NA 69	NA 48	TAFI	TRI	GTRI	g	d
50	—	—	—	TAFI 506825	—	—	270	50
	NA 4910	—	—	TAFI 506835	—	—	365	50
	—	NA 6910	—	—	—	—	295	50
	—	—	—	—	—	—	530	50
55	—	—	—	—	TRI 507745	—	755	50
	—	—	—	—	—	GTRI 507745	825	50
	NA 4911	—	—	TAFI 557225	—	—	275	55
	—	NA 6911	—	TAFI 557235	—	—	380	55
60	—	—	—	—	—	—	410	55
	—	—	—	—	—	—	730	55
	—	—	—	—	TRI 558138	—	650	55
	—	—	—	—	—	GTRI 558138	710	55
65	—	—	—	TAFI 608225	—	—	395	60
	NA 4912	—	—	TAFI 608235	—	—	560	60
	—	NA 6912	—	—	—	—	440	60
	—	—	—	—	—	—	785	60
70	—	—	—	—	TRI 608945	—	960	60
	—	—	—	—	—	GTRI 608945	1 050	60
	NA 4913	—	—	—	—	—	470	65
	—	NA 6913	—	TAFI 659035	—	—	710	65
70	—	—	—	—	—	—	840	65
	—	—	—	TAFI 709525	—	—	540	70
	NA 4914	—	—	TAFI 709535	—	—	755	70
	—	NA 6914	—	—	—	—	765	70
							1 400	70

Notes⁽¹⁾ Minimum allowable value of chamfer dimension *r*
⁽²⁾ Allowable axial shift amount of inner ring to outer ring
⁽³⁾ Allowable rotational speed applies to oil lubrication. For grease lubrication, a maximum of 60% of this value is allowable.
 Remarks1. The outer ring has an oil groove and an oil hole.
 2. No grease is prepacked. Perform proper lubrication.

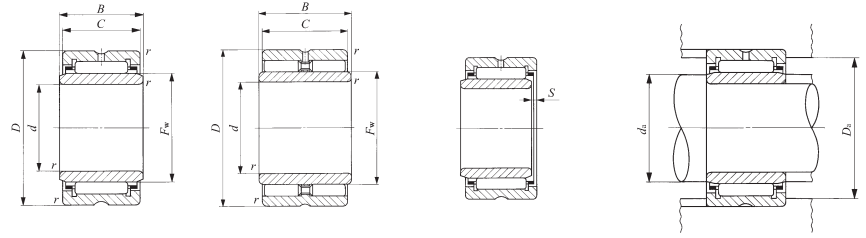

TRI

GTRI

Boundary dimensions mm						Standard mounting dimensions mm			Basic dynamic load rating	Basic static load rating	Allowable rotational speed ⁽³⁾	Assembled inner ring
D	C	B	$F_{s \min}^{(1)}$	$F_w^{(2)}$	$S^{(2)}$	Min.	d_a Max.	D_a Max.	C	C_0	rpm	
68	25	—	0.3	55	0.5	52	54	66	45 400	94 000	7 500	LRT 505525
68	35	—	0.3	55	1	52	54	66	61 200	138 000	7 500	LRT 505535
72	22	—	0.6	58	0.5	54	57	68	46 200	82 100	7 000	LRT 505822
72	40	—	0.6	58	0.3	54	57	68	79 200	164 000	7 000	LRT 505840
77	45	45.5	1	58	2	55	57	72	104 000	191 000	7 000	LRT 505845
77	45	45.5	1	58	—	55	57	72	135 000	280 000	2 500	LRTZ 505845
72	25	—	0.3	60	0.5	57	59	70	47 500	103 000	6 500	LRT 556025
72	35	—	0.3	60	1	57	59	70	64 100	151 000	6 500	LRT 556035
80	25	—	1	63	1	60	61	75	57 600	97 200	6 500	LRT 556325
80	45	—	1	63	0.5	60	61	75	98 700	194 000	6 500	LRT 556345
81	38	38.5	1	62	1.5	60	60.5	76	92 000	166 000	6 500	LRT 556238
81	38	38.5	1	62	—	60	60.5	76	118 000	241 000	2 500	LRTZ 556238
82	25	—	0.6	68	0.3	64	66	78	54 800	117 000	6 000	LRT 606825
82	35	—	0.6	68	1	64	66	78	72 000	166 000	6 000	LRT 606835
85	25	—	1	68	1	65	66	80	60 200	105 000	6 000	LRT 606825-1
85	45	—	1	68	0.5	65	66	80	103 000	211 000	6 000	LRT 606845
89	45	45.5	1	70	2	65	68	84	114 000	228 000	5 500	LRT 607045
89	45	45.5	1	70	—	65	68	84	147 000	336 000	2 000	LRTZ 607045
90	25	—	1	72	1	70	70.5	85	62 700	113 000	5 500	LRT 657225
90	35	—	1	73	1	70	71	85	80 400	181 000	5 500	LRT 657335
90	45	—	1	72	0.5	70	70.5	85	108 000	227 000	5 500	LRT 657245
95	25	—	1	80	0.3	75	78	90	59 400	137 000	5 000	LRT 708025
95	35	—	1	80	1	75	78	90	78 100	195 000	5 000	LRT 708035
100	30	—	1	80	1.5	75	78	95	83 200	158 000	5 000	LRT 708030
100	54	—	1	80	1	75	78	95	134 000	311 000	5 000	LRT 708054

1N=0.102kgf=0.2248lbs.
 1mm=0.03937inch

MACHINED TYPE NEEDLE ROLLER BEARINGS

With Inner Ring

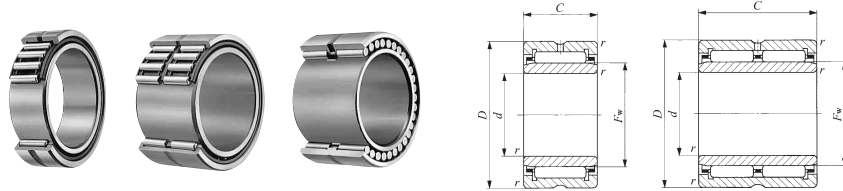

NA49 TAFI

NA69

Shaft dia. 75 – 90mm

Shaft dia. mm	Identification number						Mass (Ref.) g	
	NA 49	NA 69	NA 48	TAFI	TRI	GTRI	<i>d</i>	<i>d</i>
75	—	—	—	TAFI 7510525	—	—	675	75
	NA 4915	—	—	TAFI 7510535	—	—	810	75
	—	NA 6915	—	—	—	—	945	75
	—	—	—	—	TRI 7510845	—	1 340	75
	—	—	—	—	—	GTRI 7510845	1 440	75
80	—	—	—	TAFI 8011025	—	—	710	80
	NA 4916	—	—	TAFI 8011035	—	—	855	80
	—	NA 6916	—	—	—	—	995	80
85	—	—	—	TAFI 8511526	—	—	775	85
	—	—	—	TAFI 8511536	—	—	1 080	85
	NA 4917	—	—	—	—	—	1 280	85
	—	NA 6917	—	—	—	—	2 340	85
	—	—	—	—	TRI 8511850	—	1 640	85
	—	—	—	—	TRI 8512045	—	1 610	85
	—	—	—	—	—	GTRI 8511850	1 780	85
90	—	—	—	TAFI 9012026	—	—	820	90
	—	—	—	TAFI 9012036	—	—	1 140	90
	NA 4918	—	—	—	—	—	1 350	90
	—	—	—	—	TRI 9012550	—	1 870	90
	—	NA 6918	—	—	—	—	2 460	90
	—	—	—	—	—	GTRI 9012550	2 020	90
	—	—	—	—	—	—	—	—
	—	—	—	—	—	—	—	—
	—	—	—	—	—	—	—	—
	—	—	—	—	—	—	—	—

Notes⁽¹⁾ Minimum allowable value of chamfer dimension *r*
⁽²⁾ Allowable axial shift amount of inner ring to outer ring
⁽³⁾ Allowable rotational speed applies to oil lubrication. For grease lubrication, a maximum of 60% of this value is allowable.
 Remarks1. The outer ring has an oil groove and an oil hole.
 2. No grease is prepacked. Perform proper lubrication.

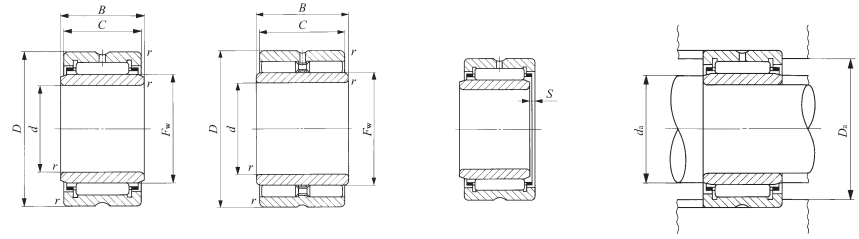

TRI

GTRI

Boundary dimensions mm						Standard mounting dimensions mm			Basic dynamic load rating <i>C</i> N	Basic static load rating <i>C</i> ₀ N	Allowable rotational speed ⁽³⁾ rpm	Assembled inner ring	
<i>D</i>	<i>C</i>	<i>B</i>	<i>r</i> _{s min} ⁽¹⁾	<i>F</i> _w ⁽²⁾	<i>S</i> ⁽²⁾	Min. <i>d</i> _a	Max.	<i>D</i> _a Max.					
105	25	—	1	85	0.5	80	83	100	76 300	145 000	4 500	LRT	758525
105	30	—	1	85	1.5	80	83	100	86 200	169 000	4 500	LRT	758530
105	35	—	1	85	1.5	80	83	100	102 000	210 000	4 500	LRT	758535
105	54	—	1	85	1	80	83	100	138 000	331 000	4 500	LRT	758554
108	45	45.5	1	83	2.5	80	81	103	146 000	270 000	5 000	LRT	758345
108	45	45.5	1	83	—	80	81	103	190 000	396 000	1 800	LRTZ	758345
110	25	—	1	90	0.5	85	88	105	77 300	150 000	4 500	LRT	809025
110	30	—	1	90	1.5	85	88	105	87 300	175 000	4 500	LRT	809030
110	35	—	1	90	1.5	85	88	105	103 000	217 000	4 500	LRT	809035
110	54	—	1	90	1	85	88	105	143 000	351 000	4 500	LRT	809054
115	26	—	1	95	1	90	93	110	79 700	159 000	4 000	LRT	859526
115	36	—	1	95	2	90	93	110	106 000	231 000	4 000	LRT	859536
120	35	—	1.1	100	1	91.5	98	113.5	110 000	244 000	4 000	LRT	8510035
120	63	—	1.1	100	0.5	91.5	98	113.5	173 000	467 000	4 000	LRT	8510063
118	50	50.5	1	93	3	90	91	113	165 000	329 000	4 500	LRT	859350
120	45	45.5	1.5	95	2.5	93	93.5	112	155 000	305 000	4 000	LRT	859545
118	50	50.5	1	93	—	90	91	113	224 000	509 000	1 600	LRTZ	859350
120	45	45.5	1.5	95	—	93	93.5	112	204 000	455 000	1 600	LRTZ	859545
120	26	—	1	100	1	95	98	115	82 400	168 000	4 000	LRT	9010026
120	36	—	1	100	2	95	98	115	110 000	244 000	4 000	LRT	9010036
125	35	—	1.1	105	1	96.5	103	118.5	113 000	258 000	4 000	LRT	9010535
125	50	50.5	1.5	100	3	98	98.5	117	172 000	355 000	4 000	LRT	9010050
125	63	—	1.1	105	0.5	96.5	103	118.5	178 000	490 000	4 000	LRT	9010563
125	50	50.5	1.5	100	—	98	98.5	117	234 000	549 000	1 500	LRTZ	9010050

1N=0.102kgf=0.2248lbs.
 1mm=0.03937inch

MACHINED TYPE NEEDLE ROLLER BEARINGS

With Inner Ring

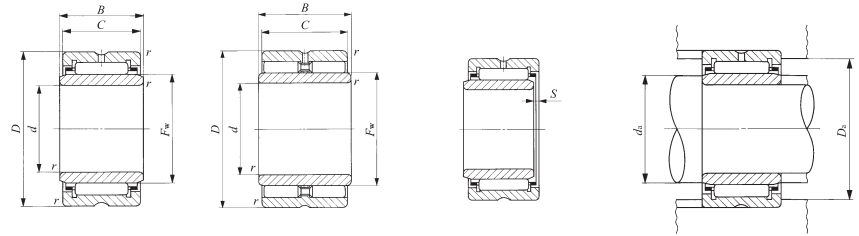
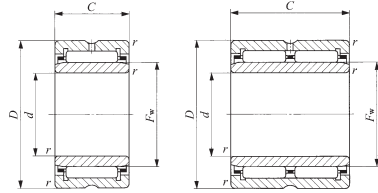

Shaft dia. 95 – 150mm

NA49 TAFI NA48 NA69

Shaft dia. mm	Identification number						Mass (Ref.)	
	NA 49	NA 69	NA 48	TAFI	TRI	GTRI	g	d
95	—	—	—	TAFI 9512526	—	—	860	95
	NA 4919	—	—	TAFI 9512536	—	—	1 190	95
	—	NA 6919	—	—	—	—	1 420	95
	—	—	—	—	—	—	2 580	95
100	—	—	—	TAFI 10013030	—	—	1 040	100
	—	—	—	TAFI 10013040	—	—	1 380	100
	NA 4920	—	—	—	TRI 10013550	—	2 040	100
	—	—	—	—	—	GTRI 10013550	1 960	100
105	—	—	—	—	TRI 10515350	—	3 020	105
	—	—	—	—	—	GTRI 10515350	3 270	105
110	—	—	NA 4822	—	—	—	1 200	110
	NA 4922	—	—	—	—	—	2 120	110
120	—	—	NA 4824	—	—	—	1 300	120
	NA 4924	—	—	—	—	—	2 960	120
125	—	—	—	—	TRI 12517860	—	4 780	125
	—	—	—	—	—	GTRI 12517860	5 180	125
130	—	—	NA 4826	—	—	—	1 960	130
	NA 4926	—	—	—	—	—	4 030	130
135	—	—	—	—	TRI 13518860	—	5 100	135
	—	—	—	—	—	GTRI 13518860	5 530	135
140	—	—	NA 4828	—	—	—	2 100	140
	NA 4928	—	—	—	—	—	4 290	140
150	—	—	NA 4830	—	—	—	2 880	150
	NA 4930	—	—	—	—	—	6 380	150

Notes⁽¹⁾ Minimum allowable value of chamfer dimension r
⁽²⁾ Allowable axial shift amount of inner ring to outer ring
⁽³⁾ Allowable rotational speed applies to oil lubrication. For grease lubrication, a maximum of 60% of this value is allowable.
 Remarks 1. The outer ring has an oil groove and an oil hole.
 2. No grease is prepacked. Perform proper lubrication.

Boundary dimensions mm						Standard mounting dimensions mm			Basic dynamic load rating	Basic static load rating	Allowable rotational speed ⁽³⁾	Assembled inner ring
D	C	B	F_s min ⁽¹⁾	F_w	S ⁽²⁾	Min. d_a	Max. d_a	D_a Max.	C	C_0	rpm	
125	26	—	1	105	1	100	103	120	84 700	178 000	4 000	LRT 9510526
125	36	—	1	105	2	100	103	120	113 000	258 000	4 000	LRT 9510536
130	35	—	1.1	110	1	101.5	108	123.5	116 000	271 000	3 500	LRT 9511035
130	63	—	1.1	110	0.5	101.5	108	123.5	182 000	514 000	3 500	LRT 9511063
130	30	—	1	110	0.5	105	108	125	106 000	240 000	3 500	LRT 10011030
130	40	—	1	110	1.5	105	108	125	134 000	324 000	3 500	LRT 10011040
135	50	50.5	1.5	110	3	108	108.5	127	183 000	395 000	3 500	LRT 10011050
140	40	—	1.1	115	1	106.5	113	133.5	145 000	329 000	3 500	LRT 10011540
135	50	50.5	1.5	110	—	108	108.5	127	245 000	603 000	1 400	LRTZ 10011050
153	50	50.5	1.5	115	3	113	113.5	145	233 000	414 000	3 500	LRT 10511550
153	50	50.5	1.5	115	—	113	113.5	145	315 000	614 000	1 300	LRTZ 10511550
140	30	—	1	120	1	115	118	135	93 200	239 000	3 500	LRT 11012030
150	40	—	1.1	125	1	116.5	123	143.5	152 000	357 000	3 000	LRT 11012540
150	30	—	1	130	1	125	128	145	96 900	259 000	3 000	LRT 12013030
165	45	—	1.1	135	2	126.5	133	158.5	187 000	435 000	3 000	LRT 12013545
178	60	60.5	1.5	140	2.5	133	138	170	307 000	625 000	3 000	LRT 12514060
178	60	60.5	1.5	140	—	133	138	170	409 000	923 000	1 100	LRTZ 12514060
165	35	—	1.1	145	1	136.5	143	158.5	116 000	340 000	3 000	LRT 13014535
180	50	—	1.5	150	2.5	138	148	172	215 000	540 000	2 500	LRT 13015050
188	60	60.5	1.5	150	2.5	143	148	180	320 000	675 000	2 500	LRT 13515060
188	60	60.5	1.5	150	—	143	148	180	423 000	989 000	1 000	LRTZ 13515060
175	35	—	1.1	155	1	146.5	153	168.5	120 000	363 000	2 500	LRT 14015535
190	50	—	1.5	160	2.5	148	158	182	224 000	580 000	2 500	LRT 14016050
190	40	—	1.1	165	1.5	156.5	163	183.5	168 000	446 000	2 500	LRT 15016540
210	60	—	2	170	3	159	168	201	324 000	712 000	2 500	LRT 15017060

1N=0.102kgf=0.2248lbs.
 1mm=0.03937inch

MACHINED TYPE NEEDLE ROLLER BEARINGS

With Inner Ring



Shaft dia. 160 – 340mm

Shaft dia. mm	Identification number						Mass (Ref.) g	<i>d</i>
	NA 49	NA 69	NA 48	TAFI	TRI	GTRI		
160	—	—	NA 4832	—	—	—	3 050	160
	NA 4932	—	—	—	—	—	6 750	160
170	—	—	NA 4834	—	—	—	4 120	170
	NA 4934	—	—	—	—	—	7 110	170
180	—	—	NA 4836	—	—	—	4 340	180
	NA 4936	—	—	—	—	—	10 200	180
190	—	—	NA 4838	—	—	—	5 760	190
	NA 4938	—	—	—	—	—	10 700	190
200	—	—	NA 4840	—	—	—	6 040	200
	NA 4940	—	—	—	—	—	15 400	200
220	—	—	NA 4844	—	—	—	6 570	220
	NA 4944	—	—	—	—	—	16 700	220
240	—	—	NA 4848	—	—	—	10 200	240
	NA 4948	—	—	—	—	—	18 000	240
260	—	—	NA 4852	—	—	—	11 000	260
	NA 4952	—	—	—	—	—	31 100	260
280	—	—	NA 4856	—	—	—	15 800	280
	NA 4956	—	—	—	—	—	33 100	280
300	—	—	NA 4860	—	—	—	22 300	300
	NA 4960	—	—	—	—	—	51 400	300
320	—	—	NA 4864	—	—	—	23 700	320
	NA 4964	—	—	—	—	—	54 400	320
340	—	—	NA 4868	—	—	—	25 000	340
	NA 4968	—	—	—	—	—	57 300	340

Notes⁽¹⁾ Minimum allowable value of chamfer dimension *r*
⁽²⁾ Allowable axial shift amount of inner ring to outer ring
⁽³⁾ Allowable rotational speed applies to oil lubrication. For grease lubrication, a maximum of 60% of this value is allowable.
 Remarks 1. The outer ring has an oil groove and an oil hole.
 2. No grease is prepacked. Perform proper lubrication.

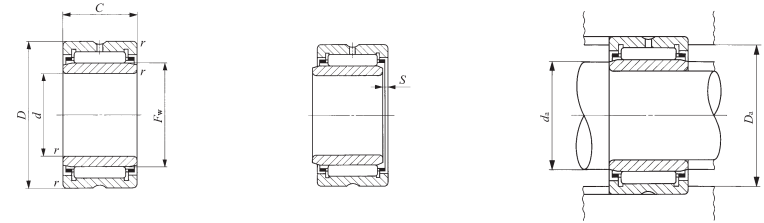

NA49 NA48

Boundary dimensions mm						Standard mounting dimensions mm			Basic dynamic load rating <i>C</i> N	Basic static load rating <i>C</i> ₀ N	Allowable rotational speed ⁽³⁾ rpm	Assembled inner ring
<i>D</i>	<i>C</i>	<i>B</i>	<i>r</i> _{s min} ⁽¹⁾	<i>F</i> _w ⁽²⁾	<i>S</i>	Min. <i>d</i> _a	Max.	<i>D</i> _a Max.				
200	40	—	1.1	175	1.5	166.5	173	193.5	173 000	474 000	2 500	LRT 16017540
220	60	—	2	180	3	169	178	211	337 000	761 000	1 900	LRT 16018060
215	45	—	1.1	185	1.5	176.5	183	208.5	211 000	567 000	1 900	LRT 17018545
230	60	—	2	190	3	179	188	221	347 000	810 000	1 900	LRT 17019060
225	45	—	1.1	195	1.5	186.5	193	218.5	218 000	602 000	1 900	LRT 18019545
250	69	—	2	205	3	189	203	241	434 000	989 000	1 900	LRT 18020569
240	50	—	1.5	210	1.5	198	208	232	249 000	726 000	1 800	LRT 19021050
260	69	—	2	215	3	199	213	251	440 000	1 020 000	1 700	LRT 19021569
250	50	—	1.5	220	1.5	208	218	242	255 000	766 000	1 600	LRT 20022050
280	80	—	2.1	225	4	211	223	269	518 000	1 120 000	1 600	LRT 20022580
270	50	—	1.5	240	1.5	228	238	262	266 000	833 000	1 500	LRT 22024050
300	80	—	2.1	245	4	231	243	289	536 000	1 200 000	1 400	LRT 22024580
300	60	—	2	265	2	249	262	291	345 000	1 150 000	1 300	LRT 24026560
320	80	—	2.1	265	4	251	262	309	565 000	1 320 000	1 300	LRT 24026580
320	60	—	2	285	2	269	282	311	354 000	1 220 000	1 100	LRT 26028560
360	100	—	2.1	290	4	271	287	349	847 000	1 900 000	1 100	LRT 260290100
350	69	—	2	305	2.5	289	302	341	486 000	1 550 000	950	LRT 28030569
380	100	—	2.1	310	4	291	307	369	877 000	2 040 000	950	LRT 280310100
380	80	—	2.1	330	2.5	311	327	369	610 000	1 900 000	900	LRT 30033080
420	118	—	3	340	4	313	337	407	1 130 000	2 650 000	850	LRT 300340118
400	80	—	2.1	350	2.5	331	347	389	635 000	2 040 000	750	LRT 32035080
440	118	—	3	360	4	333	357	427	1 170 000	2 830 000	750	LRT 320360118
420	80	—	2.1	370	2.5	351	367	409	651 000	2 140 000	700	LRT 34037080
460	118	—	3	380	4	353	377	447	1 220 000	3 020 000	700	LRT 340380118

1N=0.102kgf=0.2248lbs.
 1mm=0.03937inch

MACHINED TYPE NEEDLE ROLLER BEARINGS

With Inner Ring



Shaft dia. 360 – 440mm

Shaft dia. mm	Identification number						Mass (Ref.) g	<i>d</i>
	NA 49	NA 69	NA 48	TAFI	TRI	GTRI		
360	—	—	NA 4872	—	—	—	26 400	360
	NA 4972	—	—	—	—	—	60 200	360
380	—	—	NA 4876	—	—	—	44 600	380
	NA 4976	—	—	—	—	—	90 300	380
400	NA 4980	—	—	—	—	—	94 400	400
420	NA 4984	—	—	—	—	—	98 500	420
440	NA 4988	—	—	—	—	—	131 000	440

- Notes⁽¹⁾ Minimum allowable value of chamfer dimension *r*
⁽²⁾ Allowable axial shift amount of inner ring to outer ring
⁽³⁾ Allowable rotational speed applies to oil lubrication. For grease lubrication, a maximum of 60% of this value is allowable.
 Remarks1. The outer ring has an oil groove and an oil hole.
 2. No grease is prepacked. Perform proper lubrication.

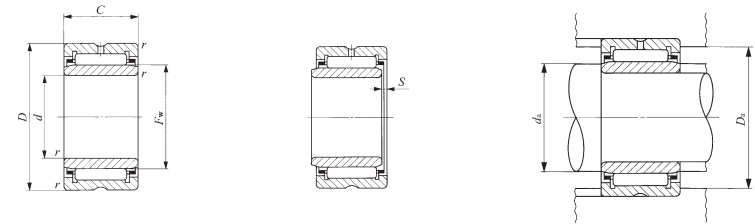

NA49 NA48

Boundary dimensions mm	Standard mounting dimensions mm					Basic dynamic load rating <i>C</i> N	Basic static load rating <i>C</i> ₀ N	Allowable rotational speed ⁽³⁾ rpm	Assembled inner ring			
	<i>D</i>	<i>C</i>	<i>B</i>	<i>r</i> _{s min} ⁽¹⁾	<i>F</i> _w ⁽²⁾					Min. <i>d</i> _a	Max. <i>D</i> _a	
440	80	—	2.1	390	2.5	371	387	429	680 000	2 320 000	650	LRT 36039080
480	118	—	3	400	4	373	397	467	1 260 000	3 200 000	600	LRT 360400118
480	100	—	2.1	415	3	391	412	469	951 000	2 860 000	600	LRT 380415100
520	140	—	4	430	5	396	427	504	1 540 000	4 030 000	500	LRT 380430140
540	140	—	4	450	5	416	447	524	1 590 000	4 270 000	500	LRT 400450140
560	140	—	4	470	5	436	467	544	1 640 000	4 510 000	500	LRT 420470140
600	160	—	4	490	5	456	487	584	1 910 000	5 140 000	400	LRT 440490160

1N=0.102kgf=0.2248lbs.
 1mm=0.03937inch

MACHINED TYPE NEEDLE ROLLER BEARINGS

Without Inner Ring, Inch Series



Shaft dia. 15.875 – 47.625mm

Shaft dia. mm (inch)	Identification number	Mass (Ref.) g	Boundary dimensions mm(inch)			Standard mounting dimensions mm	
			F_w	D	C	D_a Max.	$r_{as\ max}^{(1)}$
15.875 ($\frac{5}{8}$)	BR 101812	49	15.875 ($\frac{5}{8}$)	28.575 (1 $\frac{1}{8}$)	19.050 ($\frac{3}{4}$)	24.5	0.6
19.050 ($\frac{3}{4}$)	BR 122012	56	19.050 ($\frac{3}{4}$)	31.750 (1 $\frac{1}{4}$)	19.050 ($\frac{3}{4}$)	26.5	1
	BR 122016	75	19.050 ($\frac{3}{4}$)	31.750 (1 $\frac{1}{4}$)	25.400 (1)	26.5	1
22.225 ($\frac{7}{8}$)	BR 142212	63	22.225 ($\frac{7}{8}$)	34.925 (1 $\frac{3}{8}$)	19.050 ($\frac{3}{4}$)	29.7	1
	BR 142216	84.5	22.225 ($\frac{7}{8}$)	34.925 (1 $\frac{3}{8}$)	25.400 (1)	29.7	1
25.400 (1)	BR 162412	69	25.400 (1)	38.100 (1 $\frac{1}{2}$)	19.050 ($\frac{3}{4}$)	32.9	1
	BR 162416	92.5	25.400 (1)	38.100 (1 $\frac{1}{2}$)	25.400 (1)	32.9	1
28.575 (1 $\frac{1}{8}$)	BR 182616	102	28.575 (1 $\frac{1}{8}$)	41.275 (1 $\frac{3}{8}$)	25.400 (1)	36	1
	BR 182620	128	28.575 (1 $\frac{1}{8}$)	41.275 (1 $\frac{3}{8}$)	31.750 (1 $\frac{1}{4}$)	36	1
31.750 (1 $\frac{1}{4}$)	BR 202816	110	31.750 (1 $\frac{1}{4}$)	44.450 (1 $\frac{3}{8}$)	25.400 (1)	39.2	1
	BR 202820	138	31.750 (1 $\frac{1}{4}$)	44.450 (1 $\frac{3}{8}$)	31.750 (1 $\frac{1}{4}$)	39.2	1
34.925 (1 $\frac{3}{8}$)	BR 223016	119	34.925 (1 $\frac{3}{8}$)	47.625 (1 $\frac{3}{8}$)	25.400 (1)	42.4	1
	BR 223020	149	34.925 (1 $\frac{3}{8}$)	47.625 (1 $\frac{3}{8}$)	31.750 (1 $\frac{1}{4}$)	42.4	1
38.100 (1 $\frac{1}{2}$)	BR 243316	149	38.100 (1 $\frac{1}{2}$)	52.388 (2 $\frac{3}{16}$)	25.400 (1)	45.1	1.5
	BR 243320	187	38.100 (1 $\frac{1}{2}$)	52.388 (2 $\frac{3}{16}$)	31.750 (1 $\frac{1}{4}$)	45.1	1.5
41.275 (1 $\frac{5}{8}$)	BR 263516	158	41.275 (1 $\frac{5}{8}$)	55.562 (2 $\frac{3}{16}$)	25.400 (1)	48.3	1.5
	BR 263520	199	41.275 (1 $\frac{5}{8}$)	55.562 (2 $\frac{3}{16}$)	31.750 (1 $\frac{1}{4}$)	48.3	1.5
44.450 (1 $\frac{3}{4}$)	BR 283716	170	44.450 (1 $\frac{3}{4}$)	58.738 (2 $\frac{3}{16}$)	25.400 (1)	51.5	1.5
	BR 283720	215	44.450 (1 $\frac{3}{4}$)	58.738 (2 $\frac{3}{16}$)	31.750 (1 $\frac{1}{4}$)	51.5	1.5
	BR 283820	250	44.450 (1 $\frac{3}{4}$)	60.325 (2 $\frac{3}{16}$)	31.750 (1 $\frac{1}{4}$)	53.1	1.5
47.625 (1 $\frac{7}{8}$)	BR 303920	225	47.625 (1 $\frac{7}{8}$)	61.912 (2 $\frac{3}{8}$)	31.750 (1 $\frac{1}{4}$)	54.7	1.5

Notes⁽¹⁾ Maximum permissible corner radius of the housing
⁽²⁾ Allowable rotational speed applies to oil lubrication. For grease lubrication, a maximum of 60% of this value is allowable.
 Remarks1. The outer ring has an oil groove and an oil hole.
 2. No grease is prepacked. Perform proper lubrication.

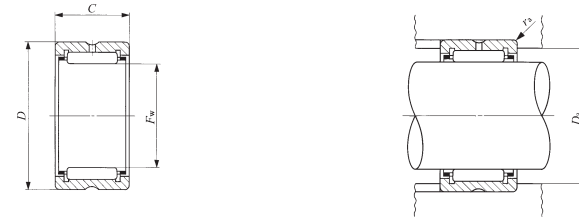

BR

Basic dynamic load rating C	Basic static load rating C_0	Allowable rotational speed ⁽²⁾
N	N	rpm
18 900	19 700	25 000
21 700	24 400	20 000
27 600	33 100	20 000
23 000	27 100	18 000
29 100	36 800	18 000
25 300	31 900	16 000
32 100	43 300	16 000
34 900	49 900	14 000
43 200	65 600	14 000
36 000	53 500	13 000
44 600	70 300	13 000
38 500	60 000	11 000
47 700	78 900	11 000
43 700	66 900	11 000
54 200	88 200	11 000
44 800	70 900	9 500
55 600	93 400	9 500
47 500	78 200	9 000
58 900	103 000	9 000
58 900	103 000	9 000
60 100	108 000	8 500

1N=0.102kgf=0.2248lbs.
 1mm=0.03937inch

MACHINED TYPE NEEDLE ROLLER BEARINGS

Without Inner Ring, Inch Series



Shaft dia. 50.800 – 101.600mm

Shaft dia. mm (inch)	Identification number	Mass (Ref.) g	Boundary dimensions mm(inch)			Standard mounting dimensions mm	
			F_w	D	C	D_a Max.	$r_{as\ max}^{(1)}$
50.800 (2)	BR 324116	190	50.800(2)	65.088(2 3/8)	25.400(1)	57.8	1.5
	BR 324120	240	50.800(2)	65.088(2 3/8)	31.750(1 1/4)	57.8	1.5
57.150 (2 1/4)	BR 364824	435	57.150(2 1/4)	7 .200(3)	38.100(1 1/2)	69	1.5
	BR 364828	510	57.150(2 1/4)	7 .200(3)	44.450(1 3/4)	69	1.5
63.500 (2 1/2)	BR 405224	475	63.500(2 1/2)	8 .550(3 1/4)	38.100(1 1/2)	74.3	2
	BR 405228	555	63.500(2 1/2)	8 .550(3 1/4)	44.450(1 3/4)	74.3	2
69.850 (2 3/4)	BR 445624	510	69.850(2 3/4)	88.900(3 1/2)	38.100(1 1/2)	80.7	2
	BR 445628	600	69.850(2 3/4)	88.900(3 1/2)	44.450(1 3/4)	80.7	2
76.200 (3)	BR 486024	555	76.200(3)	95.250(3 3/4)	38.100(1 1/2)	87	2
	BR 486028	650	76.200(3)	95.250(3 3/4)	44.450(1 3/4)	87	2
82.550 (3 1/4)	BR 526828	990	82.550(3 1/4)	107.950(4 1/4)	44.450(1 3/4)	99.7	2
	BR 526832	1 140	82.550(3 1/4)	107.950(4 1/4)	50.800(2)	99.7	2
88.900 (3 1/2)	BR 567232	1 220	88.900(3 1/2)	11 .300(4 1/2)	50.800(2)	106.1	2
95.250 (3 3/4)	BR 607632	1 290	95.250(3 3/4)	120.650(4 3/4)	50.800(2)	111.	2.5
101.600 (4)	BR 648032	1 370	101.600(4)	127.000(5)	50.800(2)	117.8	2.5

Notes(1) Maximum permissible corner radius of the housing

(2) Allowable rotational speed applies to oil lubrication. For grease lubrication, a maximum of 60% of this value is allowable.

Remarks1. In bearings with a roller set bore diameter F_w of 69.850 mm or less, the outer ring has an oil groove and an oil hole. In others, the outer ring has an oil groove and two oil holes.

2. No grease is prepacked. Perform proper lubrication.

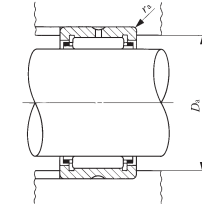
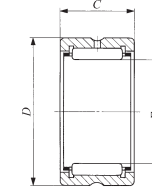

BR

Basic dynamic load rating C	Basic static load rating C_0	Allowable rotational speed(2)
N	N	rpm
51 000	89 400	8 000
63 200	118 000	8 000
0 300	158 000	7 000
105 000	191 000	7 000
94 600	174 000	6 500
110 000	210 000	6 500
98 700	189 000	5 500
114 000	228 000	5 500
105 000	211 000	5 500
122 000	255 000	5 500
141 000	259 000	5 000
154 000	290 000	5 000
162 000	316 000	4 500
169 000	342 000	4 000
176 000	368 000	4 000

1N=0.10 kgf=0.22 8lbs.
1mm=0.03937inch

MACHINED TYPE NEEDLE ROLLER BEARINGS

With Inner Ring, Inch Series



Shaft dia. 9.525 – 41.275mm

Shaft dia. mm (inch)	Identification number	Mass (Ref.) g	Boundary dimensions mm(inch)					
			d	D	C	B	F_w	⁽¹⁾ S
9.525 ($\frac{3}{8}$)	BRI 61812	67.5	9.525($\frac{3}{8}$)	28.575($1\frac{1}{8}$)	19.050($\frac{3}{4}$)	19.300	15.875($\frac{5}{8}$)	0.3
		79.5	12.700($\frac{1}{2}$)	31.750($1\frac{1}{4}$)	19.050($\frac{3}{4}$)	19.300	19.050($\frac{3}{4}$)	0.3
12.700 ($\frac{1}{2}$)	BRI 82012 BRI 82016	106	12.700($\frac{1}{2}$)	31.750($1\frac{1}{4}$)	25.400(1)	25.650	19.050($\frac{3}{4}$)	0.5
		91	15.875($\frac{5}{8}$)	34.925($1\frac{3}{8}$)	19.050($\frac{3}{4}$)	19.300	22.225($\frac{7}{8}$)	0.3
15.875 ($\frac{5}{8}$)	BRI 102212 BRI 102216	122	15.875($\frac{5}{8}$)	34.925($1\frac{3}{8}$)	25.400(1)	25.650	22.225($\frac{7}{8}$)	0.5
		102	19.050($\frac{3}{4}$)	38.100($1\frac{1}{2}$)	19.050($\frac{3}{4}$)	19.300	25.400(1)	0.3
19.050 ($\frac{3}{4}$)	BRI 122412 BRI 122416	136	19.050($\frac{3}{4}$)	38.100($1\frac{1}{2}$)	25.400(1)	25.650	25.400(1)	0.5
		152	22.225($\frac{7}{8}$)	41.275($1\frac{5}{8}$)	25.400(1)	25.650	28.575($1\frac{1}{8}$)	0.5
22.225 ($\frac{7}{8}$)	BRI 142616 BRI 142620	190	22.225($\frac{7}{8}$)	41.275($1\frac{5}{8}$)	31.750($1\frac{1}{4}$)	32.000	28.575($1\frac{1}{8}$)	0.5
		166	25.400(1)	44.450($1\frac{3}{4}$)	25.400(1)	25.650	31.750($1\frac{1}{4}$)	0.5
25.400 (1)	BRI 162816 BRI 162820	210	25.400(1)	44.450($1\frac{3}{4}$)	31.750($1\frac{1}{4}$)	32.000	31.750($1\frac{1}{4}$)	0.5
		182	28.575($1\frac{1}{8}$)	47.625($1\frac{7}{8}$)	25.400(1)	25.650	34.925($1\frac{3}{8}$)	0.5
28.575 ($1\frac{1}{8}$)	BRI 183016 BRI 183020	225	28.575($1\frac{1}{8}$)	47.625($1\frac{7}{8}$)	31.750($1\frac{1}{4}$)	32.000	34.925($1\frac{3}{8}$)	0.5
		220	31.750($1\frac{1}{4}$)	52.388($2\frac{1}{8}$)	25.400(1)	25.650	38.100($1\frac{1}{2}$)	0.5
31.750 ($1\frac{1}{4}$)	BRI 203316 BRI 203320	275	31.750($1\frac{1}{4}$)	52.388($2\frac{1}{8}$)	31.750($1\frac{1}{4}$)	32.000	38.100($1\frac{1}{2}$)	0.5
		235	34.925($1\frac{3}{8}$)	55.562($2\frac{3}{8}$)	25.400(1)	25.650	41.275($1\frac{5}{8}$)	0.5
34.925 ($1\frac{3}{8}$)	BRI 223516 BRI 223520	295	34.925($1\frac{3}{8}$)	55.562($2\frac{3}{8}$)	31.750($1\frac{1}{4}$)	32.000	41.275($1\frac{5}{8}$)	0.5
		250	38.100($1\frac{1}{2}$)	58.738($2\frac{3}{8}$)	25.400(1)	25.650	44.450($1\frac{3}{4}$)	0.5
38.100 ($1\frac{1}{2}$)	BRI 243716 BRI 243720 BRI 243820 BRI 243920	315	38.100($1\frac{1}{2}$)	58.738($2\frac{3}{8}$)	31.750($1\frac{1}{4}$)	32.000	44.450($1\frac{3}{4}$)	0.5
		350	38.100($1\frac{1}{2}$)	60.325($2\frac{3}{8}$)	31.750($1\frac{1}{4}$)	32.000	44.450($1\frac{3}{4}$)	0.5
41.275 ($1\frac{5}{8}$)	BRI 264116 BRI 264120	380	38.100($1\frac{1}{2}$)	61.912($2\frac{3}{8}$)	31.750($1\frac{1}{4}$)	32.000	47.625($1\frac{7}{8}$)	0.5
		325	41.275($1\frac{5}{8}$)	65.088($2\frac{3}{8}$)	25.400(1)	25.650	50.800(2)	0.5
		410	41.275($1\frac{5}{8}$)	65.088($2\frac{3}{8}$)	31.750($1\frac{1}{4}$)	32.000	50.800(2)	0.5

Notes⁽¹⁾ Allowable axial shift amount of inner ring to outer ring
⁽²⁾ Maximum permissible corner radius of the shaft or housing
⁽³⁾ Allowable rotational speed applies to oil lubrication. For grease lubrication, a maximum of 60% of this value is allowable.
 Remarks 1. The inner ring and the outer ring each have an oil groove and an oil hole.
 2. No grease is prepacked. Perform proper lubrication.

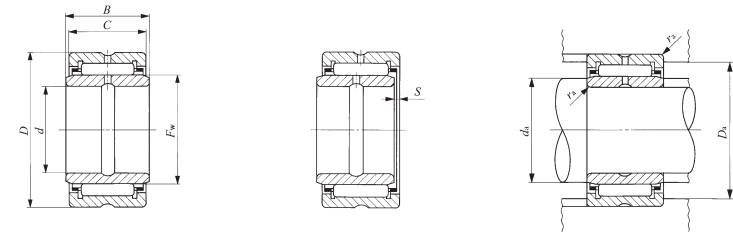

BRI

Standard mounting dimensions mm				Basic dynamic load rating C N	Basic static load rating C_0 N	Allowable rotational speed ⁽³⁾ rpm	Assembled inner ring
d_a Min.	d_a Max.	D_a Max.	$r_{as\ max}$ ⁽²⁾				
14	14.5	24.5	0.6	18 900	19 700	25 000	LRB 61012
17.5	18	26.5	1	21 700	24 400	20 000	LRB 81212
17.5	18	26.5	1	27 600	33 100	20 000	LRB 81216
21	21.2	29.7	1	23 000	27 100	18 000	LRB 101412
21	21.2	29.7	1	29 100	36 800	18 000	LRB 101416
24	24.4	32.9	1	25 300	31 900	16 000	LRB 121612
24	24.4	32.9	1	32 100	43 300	16 000	LRB 121616
27	27.5	36	1	34 900	49 900	14 000	LRB 141816
27	27.5	36	1	43 200	65 600	14 000	LRB 141820
30.5	30.7	39.2	1	36 000	53 500	13 000	LRB 162016
30.5	30.7	39.2	1	44 600	70 300	13 000	LRB 162020
33.5	33.9	42.4	1	38 500	60 000	11 000	LRB 182216
33.5	33.9	42.4	1	47 700	78 900	11 000	LRB 182220
37	37.1	45.1	1.5	43 700	66 900	11 000	LRB 202416
37	37.1	45.1	1.5	54 200	88 200	11 000	LRB 202420
40.2	40.2	48.3	1.5	44 800	70 900	9 500	LRB 222616
40.2	40.2	48.3	1.5	55 600	93 400	9 500	LRB 222620
43.3	43.4	51.5	1.5	47 500	78 200	9 000	LRB 242816
43.3	43.4	51.5	1.5	58 900	103 000	9 000	LRB 242820
43.3	43.4	53.1	1.5	58 900	103 000	9 000	LRB 242820
43.3	43.4	54.7	1.5	60 100	108 000	8 500	LRB 243020
48	49	57.8	1.5	51 000	89 400	8 000	LRB 263216
48	49	57.8	1.5	63 200	118 000	8 000	LRB 263220

1N=0.102kgf=0.2248lbs.
 1mm=0.03937inch

MACHINED TYPE NEEDLE ROLLER BEARINGS

With Inner Ring, Inch Series



Shaft dia. 44.450 – 88.900mm

Shaft dia. mm (inch)	Identification number	Mass (Ref.) g	Boundary dimensions mm(inch)					
			d	D	C	B	F_w	$S^{(1)}$
44.450 (1 3/4)	BRI 284824	735	44.450 (1 3/4)	76.200 (3)	38.100 (1 1/2)	38.350	57.150 (2 1/4)	1
	BRI 284828	855	44.450 (1 3/4)	76.200 (3)	44.450 (1 3/4)	44.700	57.150 (2 1/4)	1
50.800 (2)	BRI 325224	810	50.800 (2)	82.550 (3 1/4)	38.100 (1 1/2)	38.350	63.500 (2 1/2)	1
	BRI 325228	945	50.800 (2)	82.550 (3 1/4)	44.450 (1 3/4)	44.700	63.500 (2 1/2)	1
57.150 (2 1/4)	BRI 365624	885	57.150 (2 1/4)	88.900 (3 1/2)	38.100 (1 1/2)	38.350	69.850 (2 3/4)	1
	BRI 365628	1 040	57.150 (2 1/4)	88.900 (3 1/2)	44.450 (1 3/4)	44.700	69.850 (2 3/4)	1
63.500 (2 1/2)	BRI 406024	965	63.500 (2 1/2)	95.250 (3 3/4)	38.100 (1 1/2)	38.350	76.200 (3)	1
	BRI 406028	1 130	63.500 (2 1/2)	95.250 (3 3/4)	44.450 (1 3/4)	44.700	76.200 (3)	1
69.850 (2 3/4)	BRI 446828	1 520	69.850 (2 3/4)	107.950 (4 1/4)	44.450 (1 3/4)	44.700	82.550 (3 1/4)	1.5
	BRI 446832	1 740	69.850 (2 3/4)	107.950 (4 1/4)	50.800 (2)	51.050	82.550 (3 1/4)	3
76.200 (3)	BRI 487232	1 860	76.200 (3)	114.300 (4 1/2)	50.800 (2)	51.050	88.900 (3 1/2)	3
82.550 (3 1/4)	BRI 527632	1 980	82.550 (3 1/4)	120.650 (4 3/4)	50.800 (2)	51.050	95.250 (3 3/4)	3
88.900 (3 1/2)	BRI 568032	2 120	88.900 (3 1/2)	127.000 (5)	50.800 (2)	51.050	101.600 (4)	3

Notes⁽¹⁾ Allowable axial shift amount of inner ring to outer ring

⁽²⁾ Maximum permissible corner radius of the shaft or housing

⁽³⁾ Allowable rotational speed applies to oil lubrication. For grease lubrication, a maximum of 60% of this value is allowable.

Remarks1. In bearings with a bearing bore diameter, d , of 57.150 mm or less, the outer ring has an oil groove and an oil hole. In bearings with a bearing bore diameter, d , of 76.200 mm or less, the inner ring has an oil groove and an oil hole. In others, the inner ring and the outer ring each have an oil groove and two oil holes.

2. No grease is prepacked. Perform proper lubrication.

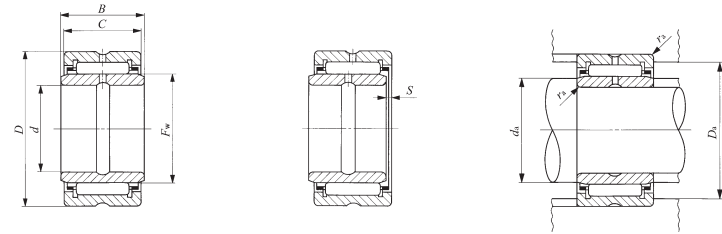

BRI

Standard mounting dimensions mm				Basic dynamic load rating C N	Basic static load rating C_0 N	Allowable rotational speed ⁽³⁾ rpm	Assembled inner ring
Min. d_a	Max. d_a	Max. D_a	$r_{as \max}^{(2)}$				
				52.5	55	69	1.5
52.5	55	69	1.5	105 000	191 000	7 000	
58	61	74.3	2	94 600	174 000	6 500	LRB 324024 LRB 324028
58	61	74.3	2	110 000	210 000	6 500	
65	67	80.7	2	98 700	189 000	5 500	LRB 364424 LRB 364428
65	67	80.7	2	114 000	228 000	5 500	
71	73	87	2	105 000	211 000	5 500	LRB 404824 LRB 404828
71	73	87	2	122 000	255 000	5 500	
77	79	99.7	2	141 000	259 000	5 000	LRB 445228 LRB 445232
77	79	99.7	2	154 000	290 000	5 000	
83.5	86	106.1	2	162 000	316 000	4 500	LRB 485632
91	93	111.4	2.5	169 000	342 000	4 000	LRB 526032
97	99	117.8	2.5	176 000	368 000	4 000	LRB 566432

1N=0.102kgf=0.2248lbs.

1mm=0.03937inch

MACHINED TYPE NEEDLE ROLLER BEARINGS

Without Inner Ring, Inch Series



Shaft dia. 15.875 – 50.800mm

Shaft dia. mm (inch)	Identification number	Mass (Ref.) g	Boundary dimensions mm(inch)			Standard mounting dimensions mm	
			F_w	D	C	D_a Max.	$r_{as\ max}^{(1)}$
15.875 (5/8)	GBR 101812	55.5	15.875 (5/8)	28.575 (1 1/8)	19.050 (3/4)	24.5	0.6
19.050 (3/4)	GBR 122012	63	19.050 (3/4)	31.750 (1 1/4)	19.050 (3/4)	27	0.6
22.225 (7/8)	GBR 142212	71	22.225 (7/8)	34.925 (1 3/8)	19.050 (3/4)	30	0.6
	GBR 142216	95.5	22.225 (7/8)	34.925 (1 3/8)	25.400 (1)	30	0.6
25.400 (1)	GBR 162412	79	25.400 (1)	38.100 (1 1/2)	19.050 (3/4)	33.3	0.6
	GBR 162416	106	25.400 (1)	38.100 (1 1/2)	25.400 (1)	33.3	0.6
28.575 (1 1/8)	GBR 182616	117	28.575 (1 1/8)	41.275 (1 5/8)	25.400 (1)	36.3	0.6
31.750 (1 1/4)	GBR 202816	128	31.750 (1 1/4)	44.450 (1 3/4)	25.400 (1)	39.6	0.6
34.925 (1 3/8)	GBR 223016	137	34.925 (1 3/8)	47.625 (1 7/8)	25.400 (1)	42.8	0.6
38.100 (1 1/2)	GBR 243316	168	38.100 (1 1/2)	52.388 (2 3/16)	25.400 (1)	47.3	0.6
	GBR 243320	205	38.100 (1 1/2)	52.388 (2 3/16)	31.750 (1 1/4)	47.3	0.6
41.275 (1 5/8)	GBR 263516	180	41.275 (1 5/8)	55.562 (2 1/8)	25.400 (1)	50.5	0.6
	GBR 263520	220	41.275 (1 5/8)	55.562 (2 1/8)	31.750 (1 1/4)	50.5	0.6
44.450 (1 3/4)	GBR 283720	235	44.450 (1 3/4)	58.738 (2 3/8)	31.750 (1 1/4)	53.7	0.6
	GBR 283820	275	44.450 (1 3/4)	60.325 (2 3/8)	31.750 (1 1/4)	55.3	0.6
47.625 (1 7/8)	GBR 303920	250	47.625 (1 7/8)	61.912 (2 3/8)	31.750 (1 1/4)	56.2	1
50.800 (2)	GBR 324116	215	50.800 (2)	65.088 (2 5/8)	25.400 (1)	59.2	1
	GBR 324120	265	50.800 (2)	65.088 (2 5/8)	31.750 (1 1/4)	59.2	1

Notes⁽¹⁾ Maximum permissible corner radius of the housing
⁽²⁾ Allowable rotational speed applies to oil lubrication. For grease lubrication, a maximum of 60% of this value is allowable.
 Remarks1. The outer ring has an oil groove and an oil hole.
 2. No grease is prepacked. Perform proper lubrication.

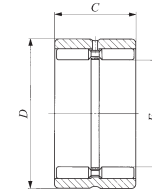

GBR

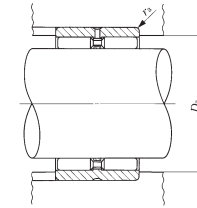

Basic dynamic load rating C	Basic static load rating C_0	Allowable rotational speed ⁽²⁾
N	N	rpm
23 500	28 500	9 500
26 400	34 500	8 000
28 600	40 100	7 000
38 300	58 300	7 000
31 000	46 100	6 000
41 400	67 100	6 000
43 900	75 300	5 500
46 600	83 900	4 500
49 500	91 800	4 500
54 200	97 700	4 000
64 100	121 000	4 000
56 600	105 000	3 500
67 000	130 000	3 500
69 700	141 000	3 500
69 700	141 000	3 500
72 400	150 000	3 000
63 100	130 000	3 000
74 600	162 000	3 000

1N=0.102kgf=0.2248lbs.
 1mm=0.03937inch

MACHINED TYPE NEEDLE ROLLER BEARINGS

Without Inner Ring, Inch Series



Shaft dia. 57.150 – 107.950mm

Shaft dia. mm (inch)	Identification number	Mass (Ref.) g	Boundary dimensions mm(inch)			Standard mounting dimensions mm	
			F_w	D	C	D_a Max.	$r_{as\ max}^{(1)}$
57.150 (2 1/4)	GBR 364824	490	57.150 (2 3/4)	76.200 (3)	38.100 (1 1/2)	69.2	1.5
	GBR 364828	580	57.150 (2 3/4)	76.200 (3)	44.450 (1 3/4)	69.2	1.5
63.500 (2 1/2)	GBR 405224	535	63.500 (2 3/2)	82.550 (3 1/4)	38.100 (1 1/2)	75.7	1.5
	GBR 405228	635	63.500 (2 3/2)	82.550 (3 1/4)	44.450 (1 3/4)	75.7	1.5
69.850 (2 3/4)	GBR 445624	585	69.850 (2 3/4)	88.900 (3 1/2)	38.100 (1 1/2)	82	1.5
	GBR 445628	690	69.850 (2 3/4)	88.900 (3 1/2)	44.450 (1 3/4)	82	1.5
76.200 (3)	GBR 486024	630	76.200 (3)	95.250 (3 3/4)	38.100 (1 1/2)	88	1.5
	GBR 486028	745	76.200 (3)	95.250 (3 3/4)	44.450 (1 3/4)	88	1.5
82.550 (3 1/4)	GBR 526828	1 100	82.550 (3 1/4)	107.950 (4 1/4)	44.450 (1 3/4)	99.9	1.5
	GBR 526832	1 240	82.550 (3 1/4)	107.950 (4 1/4)	50.800 (2)	99.9	1.5
88.900 (3 1/2)	GBR 567232	1 330	88.900 (3 1/2)	114.300 (4 1/2)	50.800 (2)	106.3	1.5
95.250 (3 3/4)	GBR 607632	1 420	95.250 (3 3/4)	120.650 (4 3/4)	50.800 (2)	112.6	1.5
101.600 (4)	GBR 648032	1 500	101.600 (4)	127.000 (5)	50.800 (2)	119	1.5
107.950 (4 1/4)	GBR 688432	1 580	107.950 (4 1/4)	133.350 (5 1/4)	50.800 (2)	125.3	1.5

Notes⁽¹⁾ Maximum permissible corner radius of the housing

⁽²⁾ Allowable rotational speed applies to oil lubrication. For grease lubrication, a maximum of 60% of this value is allowable.

Remarks 1. The outer ring has an oil groove and an oil hole.
2. No grease is prepacked. Perform proper lubrication.

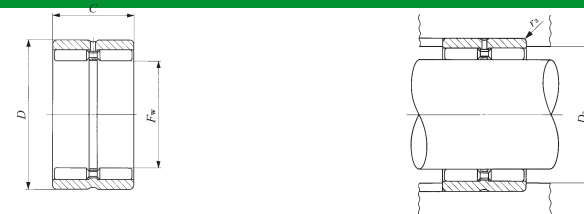

GBR

Basic dynamic load rating C	Basic static load rating C_0	Allowable rotational speed ⁽²⁾
N	N	rpm
113 000	224 000	2 500
133 000	276 000	2 500
120 000	248 000	2 500
141 000	306 000	2 500
125 000	273 000	2 000
147 000	336 000	2 000
131 000	298 000	2 000
154 000	368 000	2 000
193 000	396 000	1 800
214 000	452 000	1 800
221 000	488 000	1 700
228 000	522 000	1 600
237 000	556 000	1 500
242 000	590 000	1 400

1N=0.102kgf=0.2248lbs.
1mm=0.03937inch

MACHINED TYPE NEEDLE ROLLER BEARINGS

With Inner Ring, Inch Series



Shaft dia. 9.525 – 41.275mm

Shaft dia. mm (inch)	Identification number	Mass (Ref.) g	Boundary dimensions mm(inch)				
			d	D	C	B	F_w
9.525 ($\frac{3}{8}$)	GBRI 61812	74	9.525 ($\frac{3}{8}$)	28.575 (1 $\frac{1}{8}$)	19.050 ($\frac{3}{4}$)	19.300	15.875 ($\frac{5}{8}$)
12.700 ($\frac{1}{2}$)	GBRI 82012	86.5	12.700 ($\frac{1}{2}$)	31.750 (1 $\frac{1}{4}$)	19.050 ($\frac{3}{4}$)	19.300	19.050 ($\frac{3}{4}$)
15.875 ($\frac{5}{8}$)	GBRI 102212	99	15.875 ($\frac{5}{8}$)	34.925 (1 $\frac{3}{8}$)	19.050 ($\frac{3}{4}$)	19.300	22.225 ($\frac{7}{8}$)
	GBRI 102216	133	15.875 ($\frac{5}{8}$)	34.925 (1 $\frac{3}{8}$)	25.400 (1)	25.650	22.225 ($\frac{7}{8}$)
19.050 ($\frac{3}{4}$)	GBRI 122412	112	19.050 ($\frac{3}{4}$)	38.100 (1 $\frac{1}{2}$)	19.050 ($\frac{3}{4}$)	19.300	25.400 (1)
	GBRI 122416	150	19.050 ($\frac{3}{4}$)	38.100 (1 $\frac{1}{2}$)	25.400 (1)	25.650	25.400 (1)
22.225 ($\frac{7}{8}$)	GBRI 142616	167	22.225 ($\frac{7}{8}$)	41.275 (1 $\frac{5}{8}$)	25.400 (1)	25.650	28.575 (1 $\frac{1}{8}$)
25.400 (1)	GBRI 162816	184	25.400 (1)	44.450 (1 $\frac{3}{4}$)	25.400 (1)	25.650	31.750 (1 $\frac{1}{4}$)
28.575 (1 $\frac{1}{8}$)	GBRI 183016	200	28.575 (1 $\frac{1}{8}$)	47.625 (1 $\frac{7}{8}$)	25.400 (1)	25.650	34.925 (1 $\frac{3}{8}$)
31.750 (1 $\frac{1}{4}$)	GBRI 203316	235	31.750 (1 $\frac{1}{4}$)	52.388 (2 $\frac{1}{8}$)	25.400 (1)	25.650	38.100 (1 $\frac{1}{2}$)
	GBRI 203320	291	31.750 (1 $\frac{1}{4}$)	52.388 (2 $\frac{1}{8}$)	31.750 (1 $\frac{1}{4}$)	32.000	38.100 (1 $\frac{1}{2}$)
34.925 (1 $\frac{3}{8}$)	GBRI 223516	255	34.925 (1 $\frac{3}{8}$)	55.562 (2 $\frac{3}{8}$)	25.400 (1)	25.650	41.275 (1 $\frac{5}{8}$)
	GBRI 223520	316	34.925 (1 $\frac{3}{8}$)	55.562 (2 $\frac{3}{8}$)	31.750 (1 $\frac{1}{4}$)	32.000	41.275 (1 $\frac{5}{8}$)
38.100 (1 $\frac{1}{2}$)	GBRI 243720	335	38.100 (1 $\frac{1}{2}$)	58.738 (2 $\frac{3}{8}$)	31.750 (1 $\frac{1}{4}$)	32.000	44.450 (1 $\frac{3}{4}$)
	GBRI 243820	375	38.100 (1 $\frac{1}{2}$)	60.325 (2 $\frac{3}{8}$)	31.750 (1 $\frac{1}{4}$)	32.000	44.450 (1 $\frac{3}{4}$)
	GBRI 243920	410	38.100 (1 $\frac{1}{2}$)	61.912 (2 $\frac{3}{8}$)	31.750 (1 $\frac{1}{4}$)	32.000	47.625 (1 $\frac{7}{8}$)
41.275 (1 $\frac{5}{8}$)	GBRI 264116	350	41.275 (1 $\frac{5}{8}$)	65.088 (2 $\frac{3}{8}$)	25.400 (1)	25.650	50.800 (2)
	GBRI 264120	435	41.275 (1 $\frac{5}{8}$)	65.088 (2 $\frac{3}{8}$)	31.750 (1 $\frac{1}{4}$)	32.000	50.800 (2)

Notes⁽¹⁾ Maximum permissible corner radius of the shaft or housing

⁽²⁾ Allowable rotational speed applies to oil lubrication. For grease lubrication, a maximum of 60% of this value is allowable.

Remarks 1. The outer ring has an oil groove and an oil hole.

2. No grease is prepacked. Perform proper lubrication.

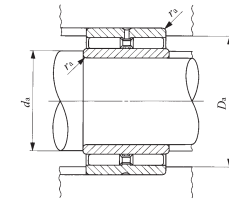
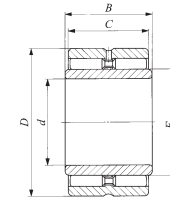

GBRI

Standard mounting dimensions mm				Basic dynamic load rating C N	Basic static load rating C_0 N	Allowable rotational speed ⁽²⁾ rpm	Assembled inner ring
d_a Min.	d_a Max.	D_a Max.	r_{as} max ⁽¹⁾				
14	14.5	24.5	0.6	23 500	28 500	9 500	LRBZ 61012
17.5	18	27	0.6	26 400	34 500	8 000	LRBZ 81212
21	21.2	30	0.6	28 600	40 100	7 000	LRBZ 101412
21	21.2	30	0.6	38 300	58 300	7 000	LRBZ 101416
24	24.4	33.3	0.6	31 000	46 100	6 000	LRBZ 121612
24	24.4	33.3	0.6	41 400	67 100	6 000	LRBZ 121616
27	27.5	36.3	0.6	43 900	75 300	5 500	LRBZ 141816
30.5	30.7	39.6	0.6	46 600	83 900	4 500	LRBZ 162016
33.5	33.9	42.8	0.6	49 500	91 800	4 500	LRBZ 182216
37	37.1	47.3	0.6	54 200	97 700	4 000	LRBZ 202416
37	37.1	47.3	0.6	64 100	121 000	4 000	LRBZ 202420
40.2	40.2	50.5	0.6	56 600	105 000	3 500	LRBZ 222616
40.2	40.2	50.5	0.6	67 000	130 000	3 500	LRBZ 222620
43.3	43.4	53.7	0.6	69 700	141 000	3 500	LRBZ 242820
43.3	43.4	55.3	0.6	69 700	141 000	3 500	LRBZ 242820
43.3	45	56.2	1	72 400	150 000	3 000	LRBZ 243020
48	49	59.2	1	63 100	130 000	3 000	LRBZ 263216
48	49	59.2	1	74 600	162 000	3 000	LRBZ 263220

1N=0.102kgf=0.2248lbs.

1mm=0.03937inch

MACHINED TYPE NEEDLE ROLLER BEARINGS

With Inner Ring, Inch Series



Shaft dia. 44.450 – 95.250mm

Shaft dia. mm (inch)	Identification number	Mass (Ref.) g	Boundary dimensions mm(inch)				
			d	D	C	B	F_w
44.450 (1 3/4)	GBRI 284824 GBRI 284828	790	44.450 (1 3/4)	76.200 (3)	38.100 (1 1/2)	38.350	57.150 (2 1/4)
		925	44.450 (1 3/4)	76.200 (3)	44.450 (1 3/4)	44.700	57.150 (2 1/4)
50.800 (2)	GBRI 325224 GBRI 325228	870	50.800 (2)	82.550 (3 1/4)	38.100 (1 1/2)	38.350	63.500 (2 1/2)
		1 030	50.800 (2)	82.550 (3 1/4)	44.450 (1 3/4)	44.700	63.500 (2 1/2)
57.150 (2 1/4)	GBRI 365624 GBRI 365628	955	57.150 (2 1/4)	88.900 (3 1/2)	38.100 (1 1/2)	38.350	69.850 (2 3/4)
		1 130	57.150 (2 1/4)	88.900 (3 1/2)	44.450 (1 3/4)	44.700	69.850 (2 3/4)
63.500 (2 1/2)	GBRI 406024 GBRI 406028	1 040	63.500 (2 1/2)	95.250 (3 3/4)	38.100 (1 1/2)	38.350	76.200 (3)
		1 230	63.500 (2 1/2)	95.250 (3 3/4)	44.450 (1 3/4)	44.700	76.200 (3)
69.850 (2 3/4)	GBRI 446828 GBRI 446832	1 630	69.850 (2 3/4)	107.950 (4 1/4)	44.450 (1 3/4)	44.700	82.550 (3 1/4)
		1 840	69.850 (2 3/4)	107.950 (4 1/4)	50.800 (2)	51.050	82.550 (3 1/4)
76.200 (3)	GBRI 487232	1 970	76.200 (3)	114.300 (4 1/2)	50.800 (2)	51.050	88.900 (3 1/2)
82.550 (3 1/4)	GBRI 527632	2 110	82.550 (3 1/4)	120.650 (4 3/4)	50.800 (2)	51.050	95.250 (3 3/4)
88.900 (3 1/2)	GBRI 568032	2 250	88.900 (3 1/2)	127.000 (5)	50.800 (2)	51.050	101.600 (4)
95.250 (3 3/4)	GBRI 608432	2 380	95.250 (3 3/4)	133.350 (5 1/4)	50.800 (2)	51.050	107.950 (4 1/4)

Notes(1) Maximum permissible corner radius of the shaft or housing

(2) Allowable rotational speed applies to oil lubrication. For grease lubrication, a maximum of 60% of this value is allowable.

Remarks1. The outer ring has an oil groove and an oil hole.
2. No grease is prepacked. Perform proper lubrication.

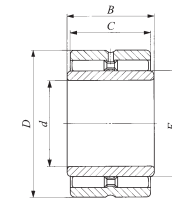

GBRI

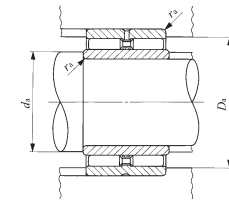

Standard mounting dimensions mm				Basic dynamic load rating C N	Basic static load rating C_0 N	Allowable rotational speed (2) rpm	Assembled inner ring
d_a Min.	d_a Max.	D_a Max.	r_{as} max (1)				
52.5	55	69.2	1.5	113 000	224 000	2 500	LRBZ 283624
52.5	55	69.2	1.5	133 000	276 000	2 500	LRBZ 283628
58	61	75.7	1.5	120 000	248 000	2 500	LRBZ 324024
58	61	75.7	1.5	141 000	306 000	2 500	LRBZ 324028
65	67	82	1.5	125 000	273 000	2 000	LRBZ 364424
65	67	82	1.5	147 000	336 000	2 000	LRBZ 364428
71	73	88	1.5	131 000	298 000	2 000	LRBZ 404824
71	73	88	1.5	154 000	368 000	2 000	LRBZ 404828
77	79	99.9	1.5	193 000	396 000	1 800	LRBZ 445228
77	79	99.9	1.5	214 000	452 000	1 800	LRBZ 445232
83.5	86	106.3	1.5	221 000	488 000	1 700	LRBZ 485632
91	93	112.6	1.5	228 000	522 000	1 600	LRBZ 526032
97	99	119	1.5	237 000	556 000	1 500	LRBZ 566432
103	105	125.3	1.5	242 000	590 000	1 400	LRBZ 606832

1N=0.102kgf=0.2248lbs.
1mm=0.03937inch

MACHINED TYPE NEEDLE ROLLER BEARINGS

With Seal, Without Inner Ring

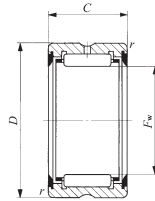

RNA49...UU
RNA69...UU ($F_w \leq 35$)

Shaft dia. 14 – 45mm

Shaft dia. mm	Identification number				Mass (Ref.) g	Boundary dimensions mm			
	With two seals	With one seal	With two seals	With one seal		F_w	D	C	$r_s^{(1)}$
14	RNA 4900UU	RNA 4900U	—	—	16.3	14	22	13	0.3
16	RNA 4901UU	RNA 4901U	—	—	17.9	16	24	13	0.3
	—	—	RNA 6901UU	RNA 6901U	30	16	24	22	0.3
18	RNA 49/14UU	RNA 49/14U	—	—	19.7	18	26	13	0.3
20	RNA 4902UU	RNA 4902U	—	—	21.5	20	28	13	0.3
	—	—	RNA 6902UU	RNA 6902U	37.5	20	28	23	0.3
22	RNA 4903UU	RNA 4903U	—	—	23	22	30	13	0.3
	—	—	RNA 6903UU	RNA 6903U	40.5	22	30	23	0.3
25	RNA 4904UU	RNA 4904U	—	—	54.5	25	37	17	0.3
	—	—	RNA 6904UU	RNA 6904U	95.5	25	37	30	0.3
28	RNA 49/22UU	RNA 49/22U	—	—	55.5	28	39	17	0.3
	—	—	RNA 69/22UU	RNA 69/22U	97.5	28	39	30	0.3
30	RNA 4905UU	RNA 4905U	—	—	63	30	42	17	0.3
	—	—	RNA 6905UU	RNA 6905U	111	30	42	30	0.3
32	RNA 49/28UU	RNA 49/28U	—	—	75.5	32	45	17	0.3
	—	—	RNA 69/28UU	RNA 69/28U	133	32	45	30	0.3
35	RNA 4906UU	RNA 4906U	—	—	71	35	47	17	0.3
	—	—	RNA 6906UU	RNA 6906U	125	35	47	30	0.3
40	RNA 49/32UU	RNA 49/32U	—	—	94.5	40	52	20	0.6
	—	—	RNA 69/32UU	RNA 69/32U	170	40	52	36	0.6
42	RNA 4907UU	RNA 4907U	—	—	112	42	55	20	0.6
	—	—	RNA 6907UU	RNA 6907U	200	42	55	36	0.6
45	RNA 49/38UU	RNA 49/38U	—	—	119	45	58	20	0.6

Notes⁽¹⁾ Minimum allowable value of chamfer dimension r

⁽²⁾ Allowable rotational speed applies to grease lubrication.

Remarks1. The outer ring has an oil groove and an oil hole.

2. Bearings with seals on both sides are provided with prepacked grease. Bearings with a seal on one side are not provided with prepacked grease. Perform proper lubrication for use.

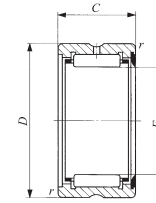

RNA49...U
RNA69...U ($F_w \leq 35$)

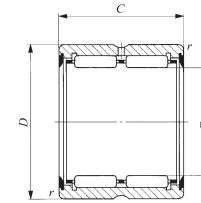

RNA69...UU

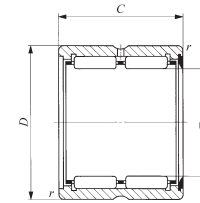

RNA69...U

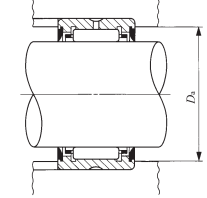

Standard mounting dimension D_a Max. mm	Basic dynamic load rating C N	Basic static load rating C_0 N	Allowable rotational speed ⁽²⁾ rpm
20	8 080	8 490	14 000
22	8 470	9 320	12 000
22	15 500	20 400	12 000
24	9 260	10 800	11 000
26	9 570	11 600	9 500
26	18 500	27 100	9 500
28	10 300	13 100	8 500
28	19 800	30 600	8 500
35	18 000	20 500	7 500
35	33 000	44 600	7 500
37	18 300	23 700	7 000
37	33 800	52 000	7 000
40	20 300	25 100	6 500
40	39 200	58 700	6 500
43	21 000	26 800	6 000
43	38 900	59 100	6 000
45	21 500	28 400	5 500
45	40 100	63 000	5 500
48	29 400	44 200	5 000
48	50 300	88 300	5 000
51	30 100	46 300	4 500
51	51 600	92 600	4 500
54	31 600	50 400	4 000

1N=0.102kgf=0.2248lbs.

1mm=0.03937inch

MACHINED TYPE NEEDLE ROLLER BEARINGS

With Seal, Without Inner Ring

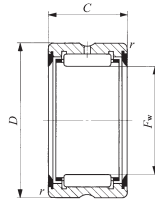

RNA49...UU

Shaft dia. 48 – 85mm

Shaft dia. mm	Identification number				Mass (Ref.) g	Boundary dimensions mm				
	With two seals	With one seal	With two seals	With one seal		F_w	D	C	$r_{s \min}^{(1)}$	
48	RNA 4908UU	RNA 4908U	—	—	150	48	62	22	0.6	
	—	—	RNA 6908UU	RNA 6908U	270	48	62	40	0.6	
50	RNA 49/42UU	RNA 49/42U	—	—	173	50	65	22	0.6	
52	RNA 4909UU	RNA 4909U	—	—	197	52	68	22	0.6	
	—	—	RNA 6909UU	RNA 6909U	355	52	68	40	0.6	
55	RNA 49/48UU	RNA 49/48U	—	—	187	55	70	22	0.6	
58	RNA 4910UU	RNA 4910U	—	—	177	58	72	22	0.6	
	—	—	RNA 6910UU	RNA 6910U	320	58	72	40	0.6	
60	RNA 49/52UU	RNA 49/52U	—	—	200	60	75	22	0.6	
63	RNA 4911UU	RNA 4911U	—	—	265	63	80	25	1	
	—	—	RNA 6911UU	RNA 6911U	470	63	80	45	1	
65	RNA 49/58UU	RNA 49/58U	—	—	275	65	82	25	1	
68	RNA 4912UU	RNA 4912U	—	—	285	68	85	25	1	
	—	—	RNA 6912UU	RNA 6912U	505	68	85	45	1	
70	RNA 49/62UU	RNA 49/62U	—	—	320	70	88	25	1	
72	RNA 4913UU	RNA 4913U	—	—	325	72	90	25	1	
	—	—	RNA 6913UU	RNA 6913U	580	72	90	45	1	
75	RNA 49/68UU	RNA 49/68U	—	—	465	75	95	30	1	
80	RNA 4914UU	RNA 4914U	—	—	495	80	100	30	1	
	—	—	RNA 6914UU	RNA 6914U	910	80	100	54	1	
85	RNA 4915UU	RNA 4915U	—	—	520	85	105	30	1	
	—	—	RNA 6915UU	RNA 6915U	960	85	105	54	1	

Notes⁽¹⁾ Minimum allowable value of chamfer dimension r

⁽²⁾ Allowable rotational speed applies to grease lubrication.

Remarks 1. The outer ring has an oil groove and an oil hole.

2. Bearings with seals on both sides are provided with prepacked grease. Bearings with a seal on one side are not provided with prepacked grease. Perform proper lubrication for use.

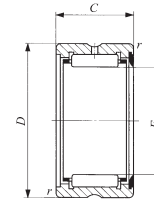

RNA49...U

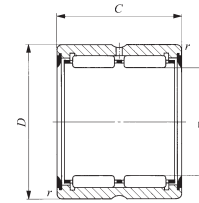

RNA69...UU

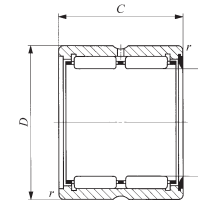

RNA69...U

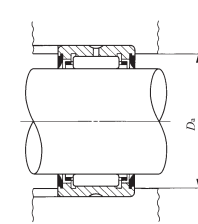

Standard mounting dimension D_a Max. mm	Basic dynamic load rating C N	Basic static load rating C_0 N	Allowable rotational speed ⁽²⁾ rpm
58	37 200	58 400	4 000
58	63 700	117 000	4 000
61	38 000	60 900	4 000
64	38 900	63 400	3 500
64	66 600	127 000	3 500
66	39 600	66 100	3 500
68	41 300	71 100	3 500
68	70 800	142 000	3 500
71	42 100	73 600	3 000
75	52 200	85 700	3 000
75	89 400	171 000	3 000
77	53 400	89 200	3 000
80	54 500	92 800	3 000
80	93 400	186 000	3 000
83	55 700	96 300	2 500
85	56 800	99 800	2 500
85	97 400	200 000	2 500
90	73 900	133 000	2 500
95	76 900	143 000	2 500
95	124 000	281 000	2 500
100	79 600	153 000	2 000
100	128 000	299 000	2 000

1N=0.102kgf=0.2248lbs.

1mm=0.03937inch

MACHINED TYPE NEEDLE ROLLER BEARINGS

With Seal, Without Inner Ring



Shaft dia. 90 – 160mm

RNA49...UU

Shaft dia. mm	Identification number				Mass (Ref.) g	Boundary dimensions mm			
	With two seals	With one seal	With two seals	With one seal		F_w	D	C	$r_s^{(1)}$
90	RNA 4916UU	RNA 4916U	—	—	545	90	110	30	1
	—	—	RNA 6916UU	RNA 6916U	1 010	90	110	54	1
95	RNA 49/82UU	RNA 49/82U	—	—	570	95	115	30	1
100	RNA 4917UU	RNA 4917U	—	—	695	100	120	35	1.1
	—	—	RNA 6917UU	RNA 6917U	1 300	100	120	3	1.1
105	RNA 4918UU	RNA 4918U	—	—	730	105	125	35	1.1
	—	—	RNA 6918UU	RNA 6918U	1 360	105	125	3	1.1
110	RNA 4919UU	RNA 4919U	—	—	760	110	130	35	1.1
	—	—	RNA 6919UU	RNA 6919U	1 420	110	130	3	1.1
115	RNA 4920UU	RNA 4920U	—	—	1 200	115	140	40	1.1
125	RNA 4922UU	RNA 4922U	—	—	1 280	125	150	40	1.1
135	RNA 4924UU	RNA 4924U	—	—	1 940	135	165	45	1.1
150	RNA 4926UU	RNA 4926U	—	—	2 360	150	180	50	1.5
160	RNA 4928UU	RNA 4928U	—	—	2 510	160	190	50	1.5

Notes⁽¹⁾ Minimum allowable value of chamfer dimension r

⁽²⁾ Allowable rotational speed applies to grease lubrication.

Remarks1. The outer ring has an oil groove and an oil hole.

2. Bearings with seals on both sides are provided with prepacked grease. Bearings with a seal on one side are not provided with prepacked grease. Perform proper lubrication for use.

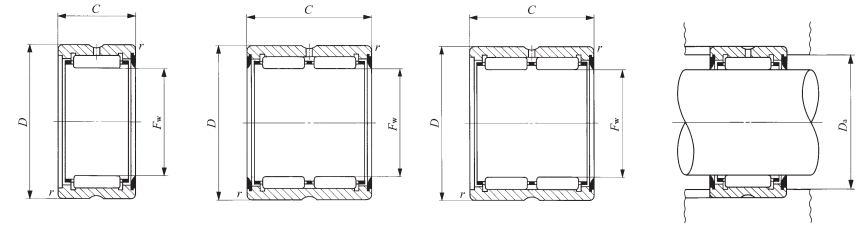

RNA49...U

RNA69...UU

RN 69...U

Standard mounting dimension D_a Max. mm	Basic dynamic load rating C N	Basic static load rating C_0 N	Allowable rotational speed ⁽²⁾ rpm
05	80 000	58 000	2 000
105	132 000	317 000	2 000
110	83 200	168 000	2 000
113.5	103 000	225 000	1 900
113.5	168 000	448 000	1 900
118.5	106 000	238 000	1 800
118.5	172 000	471 000	1 800
123.5	109 000	250 000	1 700
123.5	177 000	493 000	1 700
133.5	134 000	297 000	1 700
143.5	140 000	322 000	1 500
158.5	178 000	410 000	1 400
172	206 000	511 000	1 300
182	214 000	549 000	1 200

N=0.102kgf=0.2248lbs.
1mm=0.03937inch

MACHINED TYPE NEEDLE ROLLER BEARINGS

With Seal, With Inner Ring

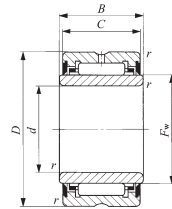

NA49...UU
NA69...UU ($d \leq 30$)

Shaft dia. 10 – 40mm

Shaft dia. mm	Identification number				Mass (Ref.) g	Boundary dimensions mm			
	With two seals	With one seal	With two seals	With one seal		d	D	C	B
10	NA 4900UU	NA 4900U	—	—	24.5	0	22	3	14
12	NA 4901UU —	NA 4901U —	—	—	27.5	2	24	3	14
			NA 6901UU	NA 6901U	45.5	2	24	22	23
15	NA 4902UU —	NA 4902U —	—	—	36	5	2	3	14
			NA 6902UU	NA 6902U	62.5	5	2	23	24
17	NA 4903UU —	NA 4903U —	—	—	39.5	7	30	3	14
			NA 6903UU	NA 6903U	68.5	7	30	23	24
20	NA 4904UU —	NA 4904U —	—	—	78.5	20	37	7	18
			NA 6904UU	NA 6904U	137	20	37	30	31
22	NA 49/22UU —	NA 49/22U —	—	—	87.5	22	39	7	18
			NA 69/22UU	NA 69/22U	153	22	39	30	31
25	NA 4905UU —	NA 4905U —	—	—	92.5	25	42	7	18
			NA 6905UU	NA 6905U	162	25	42	30	31
28	NA 49/28UU —	NA 49/28U —	—	—	101	28	4	7	18
			NA 69/28UU	NA 69/28U	177	28	4	30	31
30	NA 4906UU —	NA 4906U —	—	—	106	30	47	7	18
			NA 6906UU	NA 6906U	185	30	47	30	31
32	NA 49/32UU —	NA 49/32U —	—	—	167	32	52	20	21
			NA 69/32UU	NA 69/32U	300	32	52	36	37
35	NA 4907UU —	NA 4907U —	—	—	179	35	5	20	21
			NA 6907UU	NA 6907U	320	35	5	36	37
40	NA 4908UU —	NA 4908U —	—	—	245	40	62	22	23
			NA 6908UU	NA 6908U	440	40	62	40	41

Notes⁽¹⁾ Minimum allowable value of chamfer dimension r
⁽²⁾ Allowable rotational speed applies to grease lubrication.

Remarks 1. The outer ring has an oil groove and an oil hole.
 2. Bearings with seals on both sides are provided with prepacked grease. Bearings with a seal on one side are not provided with prepacked grease. Perform proper lubrication for use.

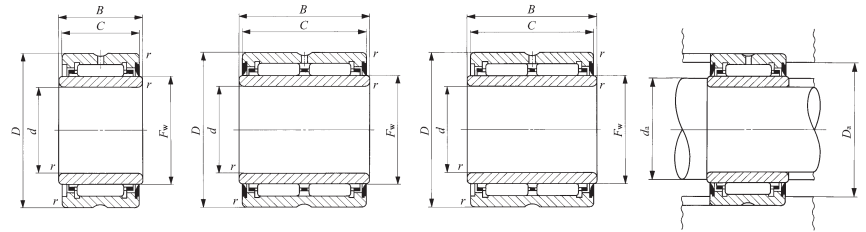

NA49...U
NA69...UU ($d \leq 30$)

NA69...UU

NA69...U

r_s min	F_w	Standard mounting dimensions mm			Basic dynamic load rating C N	Basic static load rating C_0 N	Allowable rotational speed ⁽²⁾ rpm	Assembled inner ring
		Min.	d_a Max.	D_a Max.				
0.3	14	2	3	20	080	8 490	4 000	LRTZ 101414
0.3	16	14	15	22	8 470	9 320	12 000	LRTZ 121614
		14	15	22	5 500	20 400	12 000	LRTZ 121623
0.3	20	17	19	26	9 570	11 600	9 500	LRTZ 152014
		17	19	26	8 500	27 100	9 500	LRTZ 152024
0.3	22	19	21	28	10 300	13 100	8 500	LRTZ 172214
		19	21	28	19 800	30 600	8 500	LRTZ 172224
0.3	25	22	24	35	8 000	20 500	7 500	LRTZ 202518
		22	24	35	33 000	44 600	7 500	LRTZ 202531
0.3	28	24	27	37	18 300	23 700	7 000	LRTZ 222818
		24	27	37	33 800	52 000	7 000	LRTZ 222831
0.3	30	27	29	40	20 300	25 100	6 500	LRTZ 253018
		27	29	40	39 200	58 700	6 500	LRTZ 253031
0.3	32	30	31	43	21 000	26 800	6 000	LRTZ 283218
		30	31	43	38 900	59 100	6 000	LRTZ 283231
0.3	35	32	34	45	21 500	28 400	5 500	LRTZ 303518
		32	34	45	40 100	63 000	5 500	LRTZ 303531
0.6	40	36	39	48	29 400	44 200	5 000	LRTZ 324021
		36	39	48	50 300	88 300	5 000	LRTZ 324037
0.6	42	39	41	51	30 100	46 300	4 500	LRTZ 354221
		39	41	51	51 600	92 600	4 500	LRTZ 354237
0.6	48	44	47	58	37 200	58 400	4 000	LRTZ 404823
		44	47	58	63 700	117 000	4 000	LRTZ 404841

1N=0.102kgf=0.2248lbs.
1mm=0.03937inch

MACHINED TYPE NEEDLE ROLLER BEARINGS

With Seal, With Inner Ring

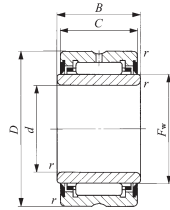

Shaft dia. 45 – 110mm

NA49...UU

Shaft dia. mm	Identification number				Mass (Ref.) g	Boundary dimensions mm			
	With two seals	With one seal	With two seals	With one seal		d	D	C	B
45	NA 4909UU	NA 4909U	—	—	290	45	68	22	23
	—	—	NA 6909UU	NA 6909U	520	45	68	40	41
50	NA 4910UU	NA 4910U	—	—	295	50	72	22	23
	—	—	NA 6910UU	NA 6910U	530	50	72	40	41
55	NA 4911UU	NA 4911U	—	—	415	55	80	25	26
	—	—	NA 6911UU	NA 6911U	730	55	80	45	46
60	NA 4912UU	NA 4912U	—	—	445	60	85	25	26
	—	—	NA 6912UU	NA 6912U	785	60	85	45	46
65	NA 4913UU	NA 4913U	—	—	475	65	90	25	26
	—	—	NA 6913UU	NA 6913U	845	65	90	45	46
70	NA 4914UU	NA 4914U	—	—	770	70	100	30	31
	—	—	NA 6914UU	NA 6914U	1 400	70	100	54	55
75	NA 4915UU	NA 4915U	—	—	815	75	105	30	31
	—	—	NA 6915UU	NA 6915U	1 480	75	105	54	55
80	NA 4916UU	NA 4916U	—	—	860	80	110	30	31
	—	—	NA 6916UU	NA 6916U	1 570	80	110	54	55
85	NA 4917UU	NA 4917U	—	—	1 300	85	120	35	36
	—	—	NA 6917UU	NA 6917U	2 360	85	120	63	64
90	NA 4918UU	NA 4918U	—	—	1 360	90	125	35	36
	—	—	NA 6918UU	NA 6918U	2 480	90	125	63	64
95	NA 4919UU	NA 4919U	—	—	1 420	95	130	35	36
	—	—	NA 6919UU	NA 6919U	2 600	95	130	63	64
100	NA 4920UU	NA 4920U	—	—	1 980	100	140	40	41
110	NA 4922UU	NA 4922U	—	—	2 150	110	150	40	41

Notes⁽¹⁾ Minimum allowable value of chamfer dimension r
⁽²⁾ Allowable rotational speed applies to grease lubrication.

Remarks1. The outer ring has an oil groove and an oil hole.
 2. Bearings with seals on both sides are provided with prepacked grease. Bearings with a seal on one side are not provided with prepacked grease. Perform proper lubrication for use.

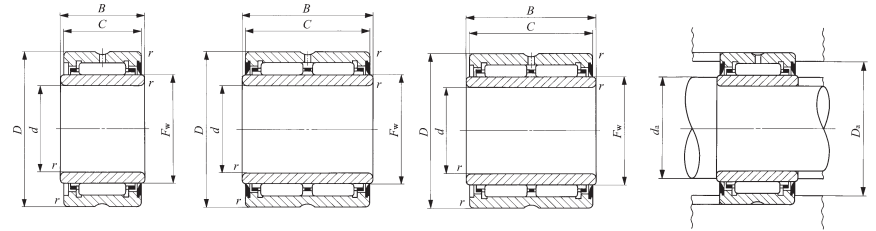

NA49...U

NA69...UU

NA69...U

r_s min	F_w	Standard mounting dimensions mm			Basic dynamic load rating C N	Basic static load rating C_0 N	Allowable rotational speed ⁽²⁾ rpm	Assembled inner ring
		Min. d_a	Max. d_a	D_a Max.				
0.6	52	49	51	64	38 900	63 400	3 500	LRTZ 455223
	52	49	51	64	66 600	127 000	3 500	LRTZ 455241
0.6	58	54	57	68	41 300	71 100	3 500	LRTZ 505823
	58	54	57	68	70 800	142 000	3 500	LRTZ 505841
1	63	60	61	75	52 200	85 700	3 000	LRTZ 556326
	63	60	61	75	89 400	171 000	3 000	LRTZ 556346
1	68	65	66	80	54 500	92 800	3 000	LRTZ 606826
	68	65	66	80	93 400	186 000	3 000	LRTZ 606846
1	72	70	70.5	85	56 800	99 800	2 500	LRTZ 657226
	72	70	70.5	85	97 400	200 000	2 500	LRTZ 657246
1	80	75	78	95	76 900	143 000	2 500	LRTZ 708031
	80	75	78	95	124 000	281 000	2 500	LRTZ 708055
1	85	80	83	100	79 600	153 000	2 000	LRTZ 758531
	85	80	83	100	128 000	299 000	2 000	LRTZ 758555
1	90	85	88	105	80 700	158 000	2 000	LRTZ 809031
	90	85	88	105	132 000	317 000	2 000	LRTZ 809055
1.1	100	91.5	98	113.5	103 000	225 000	1 900	LRTZ 8510036
	100	91.5	98	113.5	168 000	448 000	1 900	LRTZ 8510064
1.1	105	96.5	103	118.5	106 000	238 000	1 800	LRTZ 9010536
	105	96.5	103	118.5	172 000	471 000	1 800	LRTZ 9010564
1.1	110	101.5	108	123.5	109 000	250 000	1 700	LRTZ 9511036
	110	101.5	108	123.5	177 000	493 000	1 700	LRTZ 9511064
1.1	115	106.5	113	133.5	134 000	297 000	1 700	LRTZ 10011541
1.1	125	116.5	123	143.5	140 000	322 000	1 500	LRTZ 11012541

1N=0.102kgf=0.2248lbs.
 1mm=0.03937inch

D
 NA
 TAFI
 TRI
 BRI

MACHINED TYPE NEEDLE ROLLER BEARINGS

With Seal, With Inner Ring



Shaft dia. 120 – 140mm

Shaft dia. mm	Identification number				Mass (Ref.) g	Boundary dimensions mm			
	With two seals	With one seal	With two seals	With one seal		<i>d</i>	<i>D</i>	<i>C</i>	<i>B</i>
120	NA 4924UU	NA 4924U	—	—	2 990	120	165	45	46
130	NA 4926UU	NA 4926U	—	—	4 080	130	180	50	51
140	NA 4928UU	NA 4928U	—	—	4 340	140	190	50	51

Notes⁽¹⁾ Minimum allowable value of chamfer dimension *r*
⁽²⁾ Allowable rotational speed applies to grease lubrication.

Remarks1. The outer ring has an oil groove and an oil hole.
 2. Bearings with seals on both sides are provided with prepacked grease. Bearings with a seal on one side are not provided with prepacked grease. Perform proper lubrication for use.

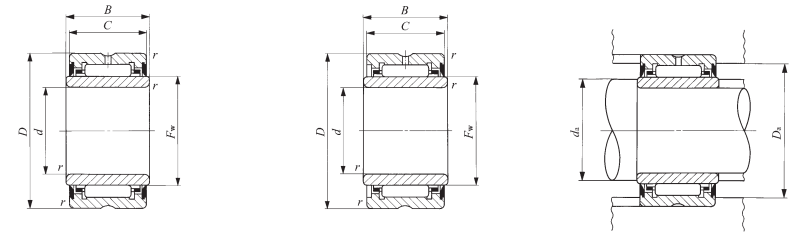

NA49...UU

NA49...U

<i>r_s</i> min ⁽¹⁾	<i>F_w</i>	Standard mounting dimensions mm			Basic dynamic load rating <i>C</i> N	Basic static load rating <i>C₀</i> N	Allowable rotational speed ⁽²⁾ rpm	Assembled inner ring
		Min. <i>d_a</i>	Max. <i>d_a</i>	Max. <i>D_a</i>				
1.1	135	126.5	133	158.5	178 000	410 000	1 400	LRTZ 12013546
1.5	150	138	148	172	206 000	511 000	1 300	LRTZ 13015051
1.5	160	148	158	182	214 000	549 000	1 200	LRTZ 14016051

1N=0.102kgf=0.2248lbs.
 1mm=0.03937inch

MACHINED TYPE NEEDLE ROLLER BEARINGS

With Seal, Without Inner Ring, Inch Series

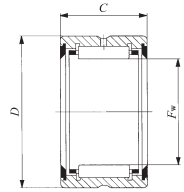

BR...UU

Shaft dia. 15.875 – 50.800mm

Shaft dia. mm (inch)	Identification number		Mass (Ref.) g	Boundary dimensions mm(inch)		
	With two seals	With one seal		F_w	D	C
15.875 ($\frac{5}{8}$)	BR 101816 UU	BR 101816 U	54	15.875 ($1\frac{5}{8}$)	28.575 ($1\frac{1}{8}$)	25.400 (1)
19.050 ($\frac{3}{4}$)	BR 122016 UU	BR 122016 U	68	19.050 ($1\frac{3}{4}$)	31.750 ($1\frac{3}{4}$)	25.400 (1)
22.225 ($\frac{7}{8}$)	BR 142216 UU	BR 142216 U	76	22.225 ($1\frac{7}{8}$)	34.925 ($1\frac{3}{8}$)	25.400 (1)
25.400 (1)	BR 162416 UU	BR 162416 U	83	25.400 (1)	38.100 ($1\frac{1}{2}$)	25.400 (1)
28.575 ($1\frac{1}{8}$)	BR 182620 UU	BR 182620 U	115	28.575 ($1\frac{1}{8}$)	41.275 ($1\frac{5}{8}$)	31.750 ($1\frac{3}{4}$)
31.750 ($1\frac{1}{4}$)	BR 202820 UU	BR 202820 U	124	31.750 ($1\frac{1}{4}$)	44.450 ($1\frac{3}{4}$)	31.750 ($1\frac{3}{4}$)
34.925 ($1\frac{3}{8}$)	BR 223020 UU	BR 223020 U	134	34.925 ($1\frac{3}{8}$)	47.625 ($1\frac{7}{8}$)	31.750 ($1\frac{3}{4}$)
38.100 ($1\frac{1}{2}$)	BR 243320 UU	BR 243320 U	168	38.100 ($1\frac{1}{2}$)	52.388 ($2\frac{1}{16}$)	31.750 ($1\frac{3}{4}$)
41.275 ($1\frac{5}{8}$)	BR 263520 UU	BR 263520 U	179	41.275 ($1\frac{5}{8}$)	55.562 ($2\frac{3}{16}$)	31.750 ($1\frac{3}{4}$)
44.450 ($1\frac{3}{4}$)	BR 283720 UU	BR 283720 U	193	44.450 ($1\frac{3}{4}$)	58.738 ($2\frac{5}{16}$)	31.750 ($1\frac{3}{4}$)
47.625 ($1\frac{7}{8}$)	BR 303920 UU	BR 303920 U	202	47.625 ($1\frac{7}{8}$)	61.912 ($2\frac{1}{16}$)	31.750 ($1\frac{3}{4}$)
50.800 (2)	BR 324120 UU	BR 324120 U	216	50.800 (2)	65.088 ($2\frac{3}{16}$)	31.750 ($1\frac{3}{4}$)

Notes⁽¹⁾ Maximum permissible corner radius of the housing
⁽²⁾ Allowable rotational speed applies to grease lubrication.

Remarks1. The outer ring has an oil groove and an oil hole.
 2. Bearings with seals on both sides are provided with prepacked grease. Bearings with a seal on one side are not provided with prepacked grease. Perform proper lubrication for use.

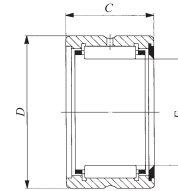

BR...U

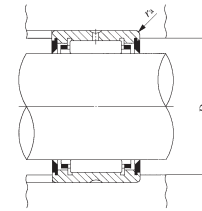

Standard mounting dimensions mm		Basic dynamic load rating C N	Basic static load rating C_0 N	Allowable rotational speed ⁽²⁾ rpm
D_a Max.	$r_{as\ max}^{(1)}$			
24.5	0.6	18 300	20 000	12 000
26.5	1.0	20 700	24 400	10 000
29.7	1.0	21 600	26 900	9 000
32.9	1.0	23 600	31 300	8 000
36.0	1.0	34 900	49 900	7 000
39.2	1.0	36 000	53 500	6 500
42.4	1.0	38 500	60 000	5 500
45.1	1.5	43 700	66 900	5 500
48.3	1.5	44 800	70 900	4 500
51.5	1.5	47 500	78 200	4 500
54.7	1.5	48 500	82 100	4 000
57.8	1.5	51 000	89 400	4 000

1N=0.102kgf=0.2248lbs.
 1mm=0.03937inch

MACHINED TYPE NEEDLE ROLLER BEARINGS

With Seal, Without Inner Ring, Inch Series

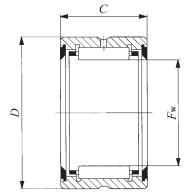

BR...UU

Shaft dia. 57.150 – 95.250mm

Shaft dia. mm (inch)	Identification number		Mass (Ref.) g	Boundary dimensions mm(inch)		
	With two seals	With one seal		F_w	D	C
57.150 (2 1/4)	BR 364828 UU	BR 364828 U	459	57.150 (2 1/4)	76.200 (3)	44.450 (1 3/4)
63.500 (2 1/2)	BR 405228 UU	BR 405228 U	499	63.500 (2 1/2)	82.550 (3 1/4)	44.450 (1 3/4)
69.850 (2 3/4)	BR 445628 UU	BR 445628 U	540	69.850 (2 3/4)	88.900 (3 1/2)	44.450 (1 3/4)
76.200 (3)	BR 486028 UU	BR 486028 U	585	76.200 (3)	95.250 (3 3/4)	44.450 (1 3/4)
82.550 (3 1/4)	BR 526828 UU	BR 526828 U	891	82.550 (3 1/4)	107.950 (4 1/4)	44.450 (1 3/4)
88.900 (3 1/2)	BR 567232 UU	BR 567232 U	1 098	88.900 (3 1/2)	114.300 (4 1/2)	50.800 (2)
95.250 (3 3/4)	BR 607632 UU	BR 607632 U	1 161	95.250 (3 3/4)	120.650 (4 3/4)	50.800 (2)

Notes(1) Maximum permissible corner radius of the housing
(2) Allowable rotational speed applies to grease lubrication.

Remarks1. The outer ring has an oil groove and an oil hole.
2. Bearings with seals on both sides are provided with prepacked grease. Bearings with a seal on one side are not provided with prepacked grease. Perform proper lubrication for use.

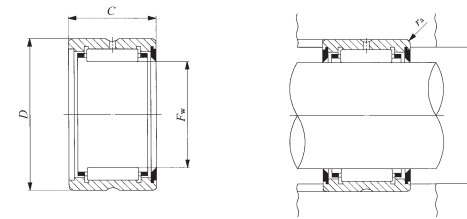

BR...U

Standard mounting dimensions mm		Basic dynamic load rating C N	Basic static load rating C_0 N	Allowable rotational speed(2) rpm
D_a Max.	r_{as} max ⁽¹⁾			
69.0	1.5	90 300	158 000	3 500
74.3	2.0	94 600	174 000	3 000
80.7	2.0	98 700	189 000	2 500
87.0	2.0	105 000	211 000	2 500
99.7	2.0	109 000	227 000	2 500
106.1	2.0	142 000	265 000	2 000
111.4	2.5	148 000	287 000	2 000

1N=0.102kgf=0.2248lbs.
1mm=0.03937inch

MACHINED TYPE NEEDLE ROLLER BEARINGS

With Seal, With Inner Ring, Inch Series

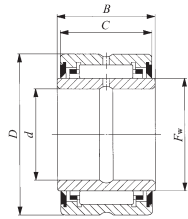

BRI...UU

Shaft dia. 9.525 – 44.450mm

Shaft dia. mm (inch)	Identification number		Mass (Ref.) g	Boundary dimensions mm(inch)			
	With two seals	With one seal		<i>d</i>	<i>D</i>	<i>C</i>	<i>B</i>
9.525 ($\frac{3}{8}$)	BRI 61816 UU	BRI 61816 U	79	9.525 ($\frac{3}{8}$)	28.575 ($1\frac{1}{8}$)	25.400 (1)	25.650
12.700 ($\frac{1}{2}$)	BRI 82016 UU	BRI 82016 U	99	12.700 ($\frac{1}{2}$)	31.750 ($1\frac{1}{4}$)	25.400 (1)	25.650
15.875 ($\frac{5}{8}$)	BRI 102216 UU	BRI 102216 U	113.5	15.875 ($\frac{5}{8}$)	34.925 ($1\frac{3}{8}$)	25.400 (1)	25.650
19.050 ($\frac{3}{4}$)	BRI 122416 UU	BRI 122416 U	127	19.050 ($\frac{3}{4}$)	38.100 ($1\frac{1}{2}$)	25.400 (1)	25.650
22.225 ($\frac{7}{8}$)	BRI 142620 UU	BRI 142620 U	177	22.225 ($\frac{7}{8}$)	41.275 ($1\frac{5}{8}$)	31.750 ($1\frac{1}{4}$)	32.000
25.400 (1)	BRI 162820 UU	BRI 162820 U	196	25.400 (1)	44.450 ($1\frac{3}{4}$)	31.750 ($1\frac{1}{4}$)	32.000
28.575 ($1\frac{1}{8}$)	BRI 183020 UU	BRI 183020 U	211	28.575 ($1\frac{1}{8}$)	47.625 ($1\frac{7}{8}$)	31.750 ($1\frac{1}{4}$)	32.000
31.750 ($1\frac{1}{4}$)	BRI 203320 UU	BRI 203320 U	254	31.750 ($1\frac{1}{4}$)	52.388 ($2\frac{1}{16}$)	31.750 ($1\frac{1}{4}$)	32.000
34.925 ($1\frac{3}{8}$)	BRI 223520 UU	BRI 223520 U	275	34.925 ($1\frac{3}{8}$)	55.562 ($2\frac{3}{16}$)	31.750 ($1\frac{1}{4}$)	32.000
38.100 ($1\frac{1}{2}$)	BRI 243720 UU BRI 243920 UU	BRI 243720 U BRI 243920 U	293 362	38.100 ($1\frac{1}{2}$) 38.100 ($1\frac{1}{2}$)	58.738 ($2\frac{5}{16}$) 61.912 ($2\frac{7}{16}$)	31.750 ($1\frac{1}{4}$) 31.750 ($1\frac{1}{4}$)	32.000 32.000
41.275 ($1\frac{5}{8}$)	BRI 264120 UU	BRI 264120 U	386	41.275 ($1\frac{5}{8}$)	65.088 ($2\frac{1}{16}$)	31.750 ($1\frac{1}{4}$)	32.000
44.450 ($1\frac{3}{4}$)	BRI 284828 UU	BRI 284828 U	804	44.450 ($1\frac{3}{4}$)	76.200 (3)	44.450 ($1\frac{3}{4}$)	44.700

Notes⁽¹⁾ Maximum permissible corner radius of the shaft or housing

⁽²⁾ Allowable rotational speed applies to grease lubrication.

Remarks1. The inner ring and the outer ring each have an oil groove and an oil hole.

2. Bearings with seals on both sides are provided with prepacked grease. Bearings with a seal on one side are not provided with prepacked grease. Perform proper lubrication for use.

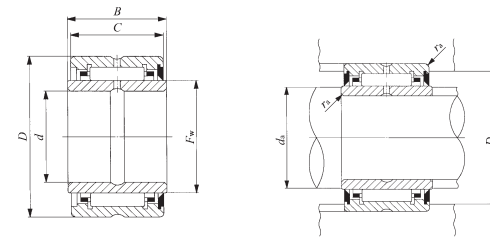

BRI...U

<i>F_w</i>	Standard mounting dimensions mm				Basic dynamic load rating <i>C</i> N	Basic static load rating <i>C₀</i> N	Allowable rotational speed ⁽²⁾ rpm	Assemble inner ring
	Min.	Max.	Max.	<i>r</i> _{as max} ⁽¹⁾				
15.875 ($\frac{5}{8}$)	14	14.5	24.5	0.6	18 300	20 000	12 000	LRBZ 61016 B
19.050 ($\frac{3}{4}$)	17.5	18	26.5	0.6	20 700	24 400	10 000	LRBZ 81216 B
22.225 ($\frac{7}{8}$)	21	21.2	29.7	0.6	21 600	26 900	9 000	LRBZ 101416 B
25.400 (1)	24	24.4	32.9	0.6	23 600	31 300	8 000	LRBZ 121616 B
28.575 ($1\frac{1}{8}$)	27	27.5	36.0	0.6	34 900	49 900	7 000	LRBZ 141820 B
31.750 ($1\frac{1}{4}$)	30.5	30.7	39.2	0.6	36 000	53 500	6 500	LRBZ 162020 B
34.925 ($1\frac{3}{8}$)	33.5	33.9	42.4	0.6	38 500	60 000	5 500	LRBZ 182220 B
38.100 ($1\frac{1}{2}$)	37	37.1	45.1	0.6	43 700	66 900	5 500	LRBZ 202420 B
41.275 ($1\frac{5}{8}$)	40.2	40.2	48.3	0.6	44 800	70 900	4 500	LRBZ 222620 B
44.450 ($1\frac{3}{4}$)	43.3	43.4	51.5	0.6	47 500	78 200	4 500	LRBZ 242820 B
47.625 ($1\frac{7}{8}$)	43.3	45	54.7	1	48 500	82 100	4 000	LRBZ 243020 B
50.800 (2)	48	49	57.8	1	51 000	89 400	4 000	LRBZ 263220 B
57.150 ($2\frac{1}{4}$)	52.5	55	69.0	1.5	90 300	158 000	3 500	LRBZ 283628 B

1N=0.102kgf=0.2248lbs.

1mm=0.03 13 in h

MACHINED TYPE NEEDLE ROLLER BEARINGS

With Seal, With Inner Ring, Inch Series

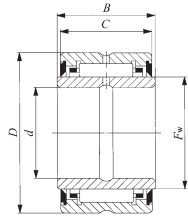

BRI...UU

Shaft dia. 50.800 – 82.550mm

Shaft dia. mm (inch)	Identification number		Mass (Ref.) g	Boundary dimensions mm(inch)			
	With two seals	With one seal		<i>d</i>	<i>D</i>	<i>C</i>	<i>B</i>
50.800 (2)	BRI 325228 UU	BRI 325228 U	889	50.800 (2)	82.550 (3 1/4)	44.450 (1 3/4)	44.700
57.150 (2 1/4)	BRI 365628 UU	BRI 365628 U	980	57.150 (2 1/4)	88.900 (3 1/2)	44.450 (1 3/4)	44.700
63.500 (2 1/2)	BRI 406028 UU	BRI 406028 U	1 065	63.500 (2 1/2)	95.250 (3 3/4)	44.450 (1 3/4)	44.700
69.850 (2 3/4)	BRI 446828 UU	BRI 446828 U	1 421	69.850 (2 3/4)	107.950 (4 1/4)	44.450 (1 3/4)	44.700
76.200 (3)	BRI 487232 UU	BRI 487232 U	1 738	76.200 (3)	114.300 (4 1/2)	50.800 (2)	51.050
82.550 (3 1/4)	BRI 527632 UU	BRI 527632 U	1 851	82.550 (3 1/4)	120.650 (4 3/4)	50.800 (2)	51.050

Notes⁽¹⁾ Maximum permissible corner radius of the shaft or housing

⁽²⁾ Allowable rotational speed applies to grease lubrication.

Remarks1. The inner ring and the outer ring each have an oil groove and an oil hole.

2. Bearings with seals on both sides are provided with prepacked grease. Bearings with a seal on one side are not provided with prepacked grease. Perform proper lubrication for use.

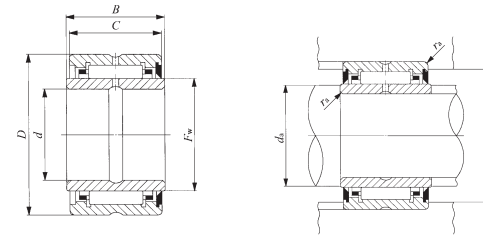

BRI...U

<i>F_w</i>	Standard mounting dimensions mm				Basic dynamic load rating <i>C</i> N	Basic static load rating <i>C₀</i> N	Allowable rotational speed ⁽²⁾ rpm	Assembled inner ring
	Min.	Max.	<i>D_a</i> Max.	<i>r_{as max}</i> ⁽¹⁾				
63.500 (2 1/2)	58	61	74.3	1.5	94 600	174 000	3 000	LRBZ 324028 B
69.850 (2 3/4)	65	67	80.7	1.5	98 700	189 000	2 500	LRBZ 364428 B
76.200 (3)	71	73	87.0	1.5	105 000	211 000	2 500	LRBZ 404828 B
82.550 (3 1/4)	77	79	99.7	1.5	109 000	227 000	2 500	LRBZ 445228 B
88.900 (3 1/2)	83.5	86	106.1	1.5	142 000	265 000	2 000	LRBZ 485632 B
95.250 (3 3/4)	91	93	111.4	1.5	148 000	287 000	2 000	LRBZ 526032 B

1N=0.102kgf=0.2248lbs.
1mm=0.03937inch

MACHINED TYPE NEEDLE ROLLER BEARINGS

With Seal, Without Inner Ring, Inch Series

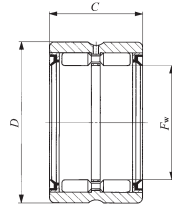

GBR...UU

Shaft dia. 15.875 – 50.800mm

Shaft dia. mm (inch)	Identification number		Mass (Ref.) g	Boundary dimensions mm(inch)		
	With two seals	With one seal		F_w	D	C
15.875 ($\frac{5}{8}$)	GBR 101816 UU	GBR 101816 U	69.5	15.875($\frac{5}{8}$)	28.575($1\frac{1}{8}$)	25.400(1)
19.050 ($\frac{3}{4}$)	GBR 122016 UU	GBR 122016 U	79	19.050($\frac{3}{4}$)	31.750($1\frac{1}{4}$)	25.400(1)
22.225 ($\frac{7}{8}$)	GBR 142216 UU	GBR 142216 U	89.5	22.225($\frac{7}{8}$)	34.925($1\frac{3}{8}$)	25.400(1)
25.400 (1)	GBR 162416 UU	GBR 162416 U	99	25.400(1)	38.100($1\frac{1}{2}$)	25.400(1)
28.575 ($1\frac{1}{8}$)	GBR 182620 UU	GBR 182620 U	139	28.575($1\frac{1}{8}$)	41.275($1\frac{5}{8}$)	31.750($1\frac{1}{4}$)
31.750 ($1\frac{1}{4}$)	GBR 202820 UU	GBR 202820 U	152	31.750($1\frac{1}{4}$)	44.450($1\frac{3}{4}$)	31.750($1\frac{1}{4}$)
34.925 ($1\frac{3}{8}$)	GBR 223020 UU	GBR 223020 U	163	34.925($1\frac{3}{8}$)	47.625($1\frac{7}{8}$)	31.750($1\frac{1}{4}$)
38.100 ($1\frac{1}{2}$)	GBR 243320 UU	GBR 243320 U	200	38.100($1\frac{1}{2}$)	52.388($2\frac{1}{8}$)	31.750($1\frac{1}{4}$)
41.275 ($1\frac{5}{8}$)	GBR 263520 UU	GBR 263520 U	215	41.275($1\frac{5}{8}$)	55.562($2\frac{3}{8}$)	31.750($1\frac{1}{4}$)
44.450 ($1\frac{3}{4}$)	GBR 283720 UU	GBR 283720 U	230	44.450($1\frac{3}{4}$)	58.738($2\frac{3}{8}$)	31.750($1\frac{1}{4}$)
47.625 ($1\frac{7}{8}$)	GBR 303920 UU	GBR 303920 U	240	47.625($1\frac{7}{8}$)	61.912($2\frac{3}{8}$)	31.750($1\frac{1}{4}$)
50.800 (2)	GBR 324120 UU	GBR 324120 U	255	50.800(2)	65.088($2\frac{3}{8}$)	31.750($1\frac{1}{4}$)

Notes(1) Maximum permissible corner radius of the shaft or housing

(2) Allowable rotational speed applies to grease lubrication.

Remarks1. The outer ring has an oil groove and an oil hole.

2. Bearings with seals on both sides are provided with prepacked grease. Bearings with a seal on one side are not provided with prepacked grease. Perform proper lubrication for use.

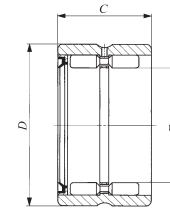

GBR...U

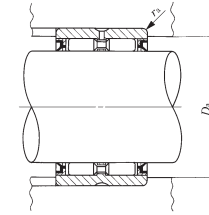

Standard mounting dimensions mm		Basic dynamic load rating C N	Basic static load rating C_0 N	Allowable rotational speed(2) rpm
D_a Max.	$r_{as \max}^{(1)}$			
24.5	0.6	23 500	28 500	5 000
27	0.6	26 400	34 500	4 000
30	0.6	28 600	40 100	3 500
33.3	0.6	31 000	46 100	3 000
36.3	0.6	43 900	75 300	3 000
39.6	0.6	46 600	83 900	2 500
42.8	0.6	49 500	91 800	2 500
47.3	0.6	54 200	97 700	2 000
50.5	0.6	56 600	105 000	1 900
53.7	0.6	58 900	114 000	1 800
56.2	1	61 100	121 000	1 700
59.2	1	63 100	130 000	1 600

1N=0.102kgf=0.2248lbs.
1mm=0.03937inch

MACHINED TYPE NEEDLE ROLLER BEARINGS

With Seal, Without Inner Ring, Inch Series

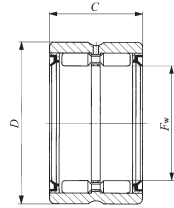

GBR...UU

Shaft dia. 57.150 – 107.950mm

Shaft dia. mm (inch)	Identification number		Mass (Ref.) g	Boundary dimensions mm(inch)		
	With two seals	With one seal		F_w	D	C
57.150 (2 1/4)	GBR 364828 UU	GBR 364828 U	515	57.150 (2 1/4)	76.200 (3)	44.450 (1 3/4)
63.500 (2 1/2)	GBR 405228 UU	GBR 405228 U	560	63.500 (2 1/2)	82.550 (3 1/4)	44.450 (1 3/4)
69.850 (2 3/4)	GBR 445628 UU	GBR 445628 U	610	69.850 (2 3/4)	88.900 (3 1/2)	44.450 (1 3/4)
76.200 (3)	GBR 486028 UU	GBR 486028 U	660	76.200 (3)	95.250 (3 3/4)	44.450 (1 3/4)
82.550 (3 1/4)	GBR 526828 UU	GBR 526828 U	960	82.550 (3 1/4)	107.950 (4 1/4)	44.450 (1 3/4)
88.900 (3 1/2)	GBR 567232 UU	GBR 567232 U	1 240	88.900 (3 1/2)	114.300 (4 1/2)	50.800 (2)
95.250 (3 3/4)	GBR 607632 UU	GBR 607632 U	1 320	95.250 (3 3/4)	120.650 (4 3/4)	50.800 (2)
101.600 (4)	GBR 648032 UU	GBR 648032 U	1 380	101.600 (4)	127.000 (5)	50.800 (2)
107.950 (4 1/4)	GBR 688432 UU	GBR 688432 U	1 460	107.950 (4 1/4)	133.350 (5 1/4)	50.800 (2)

Notes⁽¹⁾ Maximum permissible corner radius of the shaft or housing
⁽²⁾ Allowable rotational speed applies to grease lubrication.

- Remarks 1. The outer ring has an oil groove and an oil hole.
 2. Bearings with seals on both sides are provided with prepacked grease. Bearings with a seal on one side are not provided with prepacked grease. Perform proper lubrication for use.

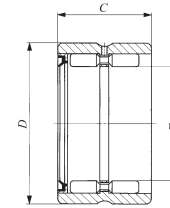

GBR...U

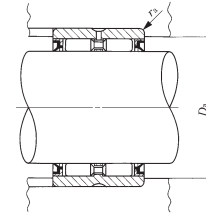

Standard mounting dimensions mm		Basic dynamic load rating C N	Basic static load rating C_0 N	Allowable rotational speed ⁽²⁾ rpm
D_a Max.	$r_{as \max}^{(1)}$			
69.2	1.5	87 500	161 000	1 400
75.7	1.5	93 300	179 000	1 300
82	1.5	97 200	197 000	1 100
88	1.5	101 000	215 000	1 100
99.9	1.5	127 000	231 000	950
106.3	1.5	170 000	347 000	900
112.6	1.5	175 000	371 000	850
119	1.5	182 000	395 000	800
125.3	1.5	186 000	419 000	750

1N=0.102kgf=0.2248lbs.
 1mm=0.03937inch

MACHINED TYPE NEEDLE ROLLER BEARINGS

With Seal, With Inner Ring, Inch Series

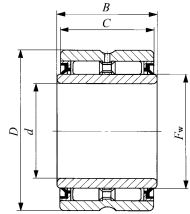

GBRI...UU

Shaft dia. 9.525 – 44.450mm

Shaft dia. mm (inch)	Identification number		Mass (Ref.) g	Boundary dimensions mm(inch)		
	With two seals	With one seal		<i>d</i>	<i>D</i>	<i>C</i>
9.525 ($\frac{3}{8}$)	GBRI 61816 UU	GBRI 61816 U	94.5	9.525($\frac{3}{8}$)	28.575(1 $\frac{1}{8}$)	25.400(1)
12.700 ($\frac{1}{2}$)	GBRI 82016 UU	GBRI 82016 U	110	12.700($\frac{1}{2}$)	31.750(1 $\frac{1}{4}$)	25.400(1)
15.875 ($\frac{5}{8}$)	GBRI 102216 UU	GBRI 102216 U	127	15.875($\frac{5}{8}$)	34.925(1 $\frac{3}{8}$)	25.400(1)
19.050 ($\frac{3}{4}$)	GBRI 122416 UU	GBRI 122416 U	143	19.050($\frac{3}{4}$)	38.100(1 $\frac{1}{2}$)	25.400(1)
22.225 ($\frac{7}{8}$)	GBRI 142620 UU	GBRI 142620 U	200	22.225($\frac{7}{8}$)	41.275(1 $\frac{5}{8}$)	31.750(1 $\frac{1}{4}$)
25.400 (1)	GBRI 162820 UU	GBRI 162820 U	220	25.400(1)	44.450(1 $\frac{3}{4}$)	31.750(1 $\frac{1}{4}$)
28.575 (1 $\frac{1}{8}$)	GBRI 183020 UU	GBRI 183020 U	240	28.575(1 $\frac{1}{8}$)	47.625(1 $\frac{7}{8}$)	31.750(1 $\frac{1}{4}$)
31.750 (1 $\frac{1}{4}$)	GBRI 203320 UU	GBRI 203320 U	286	31.750(1 $\frac{1}{4}$)	52.388(2 $\frac{1}{8}$)	31.750(1 $\frac{1}{4}$)
34.925 (1 $\frac{3}{8}$)	GBRI 223520 UU	GBRI 223520 U	311	34.925(1 $\frac{3}{8}$)	55.562(2 $\frac{1}{4}$)	31.750(1 $\frac{1}{4}$)
38.100 (1 $\frac{1}{2}$)	GBRI 243720 UU GBRI 243920 UU	GBRI 243720 U GBRI 243920 U	330 400	38.100(1 $\frac{1}{2}$) 38.100(1 $\frac{1}{2}$)	58.738(2 $\frac{3}{8}$) 61.912(2 $\frac{5}{8}$)	31.750(1 $\frac{1}{4}$) 31.750(1 $\frac{1}{4}$)
41.275 (1 $\frac{5}{8}$)	GBRI 264120 UU	GBRI 264120 U	425	41.275(1 $\frac{5}{8}$)	65.088(2 $\frac{5}{8}$)	31.750(1 $\frac{1}{4}$)
44.450 (1 $\frac{3}{4}$)	GBRI 284828 UU	GBRI 284828 U	860	44.450(1 $\frac{3}{4}$)	76.200(3)	44.450(1 $\frac{3}{4}$)

Notes⁽¹⁾ Maximum permissible corner radius of the shaft or housing
⁽²⁾ Allowable rotational speed applies to grease lubrication.

Remarks1. The outer ring has an oil groove and an oil hole.
 2. Bearings with seals on both sides are provided with prepacked grease. Bearings with a seal on one side are not provided with prepacked grease. Perform proper lubrication for use.

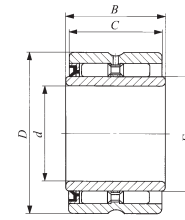

GBRI...U

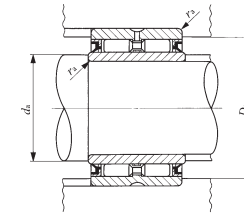

<i>B</i>	<i>F_w</i>	Standard mounting dimensions mm				Basic dynamic load rating <i>C</i> N	Basic static load rating <i>C₀</i> N	Allowable rotational speed ⁽²⁾ rpm	Assembled inner ring
		Min. <i>d_a</i>	Max. <i>d_a</i>	Max. <i>D_a</i>	<i>r_{as max}</i> ⁽¹⁾				
25.650	15.875($\frac{5}{8}$)	14	14.5	24.5	0.6	23 500	28 500	5 000	LRBZ 61016
25.650	19.050($\frac{3}{4}$)	17.5	18	27	0.6	26 400	34 500	4 000	LRBZ 81216
25.650	22.225($\frac{7}{8}$)	21	21.2	30	0.6	28 600	40 100	3 500	LRBZ 101416
25.650	25.400(1)	24	24.4	33.3	0.6	31 000	46 100	3 000	LRBZ 121616
32.000	28.575(1 $\frac{1}{8}$)	27	27.5	36.3	0.6	43 900	75 300	3 000	LRBZ 141820
32.000	31.750(1 $\frac{1}{4}$)	30.5	30.7	39.6	0.6	46 600	83 900	2 500	LRBZ 162020
32.000	34.925(1 $\frac{3}{8}$)	33.5	33.9	42.8	0.6	49 500	91 800	2 500	LRBZ 182220
32.000	38.100(1 $\frac{1}{2}$)	37	37.1	47.3	0.6	54 200	97 700	2 000	LRBZ 202420
32.000	41.275(1 $\frac{5}{8}$)	40.2	40.2	50.5	0.6	56 600	105 000	1 900	LRBZ 222620
32.000	44.450(1 $\frac{3}{4}$)	43.3	43.4	53.7	0.6	58 900	114 000	1 800	LRBZ 242820
32.000	47.625(1 $\frac{7}{8}$)	43.3	45	56.2	1	61 100	121 000	1 700	LRBZ 243020
32.000	50.800(2)	48	49	59.2	1	63 100	130 000	1 600	LRBZ 263220
44.700	57.150(2 $\frac{1}{4}$)	52.5	55	69.2	1.5	87 500	161 000	1 400	LRBZ 283628

1N=0.102kgf=0.2248lbs.
 1mm=0.03937inch

MACHINED TYPE NEEDLE ROLLER BEARINGS

With Seal, With Inner Ring, Inch Series

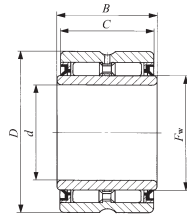

GBRI...UU

Shaft dia. 50.800 – 95.250mm

Shaft dia. mm (inch)	Identification number		Mass (Ref.) g	Boundary dimensions mm(inch)		
	With two seals	With one seal			D	C
50.800 (2)	GBRI 325228 UU	GBRI 325228 U	950	50.800(2)	82.550(3 3/4)	44.450(1 3/4)
57.150 (2 1/4)	GBRI 365628 UU	GBRI 365628 U	1 050	57.150(2 1/2)	88.900(3 1/2)	44.450(1 3/4)
63.500 (2 1/2)	GBRI 406028 UU	GBRI 406028 U	1 140	63.500(2 1/2)	95.250(3 3/4)	44.450(1 3/4)
69.850 (2 3/4)	GBRI 446828 UU	GBRI 446828 U	1 490	69.850(2 3/4)	107.950(4 1/4)	44.450(1 3/4)
76.200 (3)	GBRI 487232 UU	GBRI 487232 U	1 880	76.200(3)	114.300(4 1/2)	50.800(2)
82.550 (3 1/4)	GBRI 527632 UU	GBRI 527632 U	2 010	82.550(3 1/2)	120.650(4 3/4)	50.800(2)
88.900 (3 1/2)	GBRI 568032 UU	GBRI 568032 U	2 130	88.900(3 1/2)	127.000(5)	50.800(2)
95.250 (3 3/4)	GBRI 608432 UU	GBRI 608432 U	2 260	95.250(3 3/4)	133.350(5 1/4)	50.800(2)

Notes(1) Maximum permissible corner radius of the shaft or housing

(2) Allowable rotational speed applies to grease lubrication.

Remarks1. The outer ring has an oil groove and an oil hole.

2. Bearings with seals on both sides are provided with prepacked grease. Bearings with a seal on one side are not provided with prepacked grease. Perform proper lubrication for use.

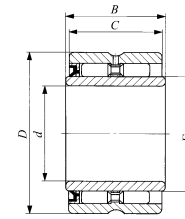

GBRI...U

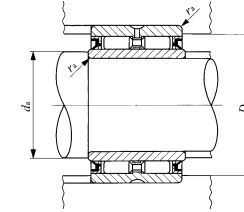

B	F _w	Standard mounting dimensions mm				Basic dynamic load rating C	Basic static load rating C ₀	Allowable rotational speed(2)	Assembled in error g
		Min. d _a	Max. d _a	Max. D _a	r _{as max}				
44.700	63.500(2 1/2)	58	61	75.7	1.5	93 300	179 000	1 300	LRBZ 324028
44.700	69.850(2 3/4)	65	67	82	1.5	97 200	197 000	1 100	LRBZ 364428
44.700	76.200(3)	71	73	88	1.5	101 000	215 000	1 100	LRBZ 404828
44.700	82.550(3 1/4)	77	79	99.9	1.5	127 000	231 000	950	LRBZ 445228
51.050	88.900(3 1/2)	83.5	86	106.3	1.5	170 000	347 000	900	LRBZ 485632
51.050	95.250(3 3/4)	91	93	112.6	1.5	175 000	371 000	850	LRBZ 526032
51.050	101.600(4)	97	99	119	1.5	182 000	395 000	800	LRBZ 566432
51.050	107.950(4 1/4)	103	105	125.3	1.5	186 000	419 000	750	LRBZ 606832

1N=0.102kgf=0.2248lbs.

1mm=0.03937i ch

NEEDLE ROLLER BEARINGS WITH SEPARABLE CAGE

- Needle Roller Bearings with Separable Cage - Without Inner Ring
- Needle Roller Bearings with Separable Cage - With Inner Ring



Structures of Needle Roller Bearings with Separable Cage

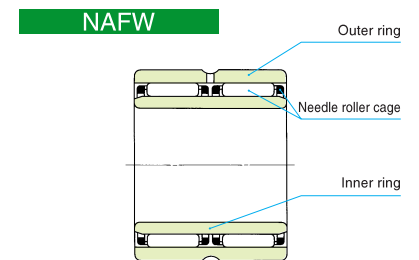
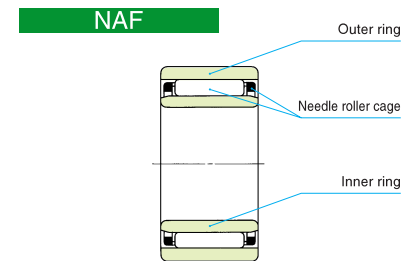
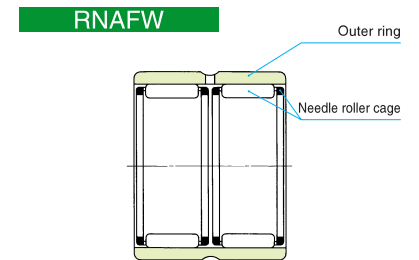
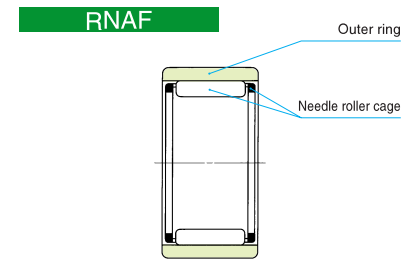

D

NAF

Types

Needle Roller Bearings with Separable Cage are available in the types shown in Table 1.

Table 1 Type of bearing

Type	Single-row		Double-row	
	Without inner ring	With inner ring	Without inner ring	With inner ring
Model code	RNAF	NAF	RNAFW	NAFW

Needle Roller Bearings with Separable Cage - Without Inner Ring

The single-row as well as the double-row types are available with the same sectional height, and either of them can be selected according to load conditions. As shown in the section, "Design of shaft and housing" on page A44, any desired radial internal clearance can be selected by combining a shaft which is heat-treated and finished by grinding.

Needle Roller Bearings with Separable Cage - With Inner Ring

These bearings are made to the CN clearance shown in Table 19 on page A37. When especially high accuracy is required, it is possible to supply semi-finished inner rings which have a finishing allowance on their outside diameter so that they can be ground after being press-fitted to shafts.

Identification Number

The identification number of Needle Roller Bearings with Separable Cage consists of a model code, dimensions, any supplemental codes and a classification symbol. The arrangement examples are as follows.

Examples of identification number

Example 1

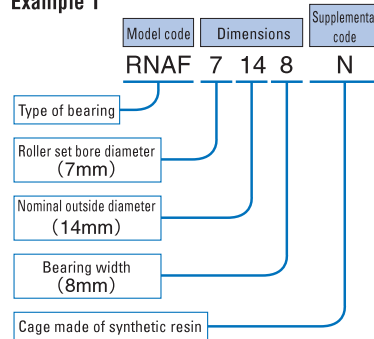

Example 2

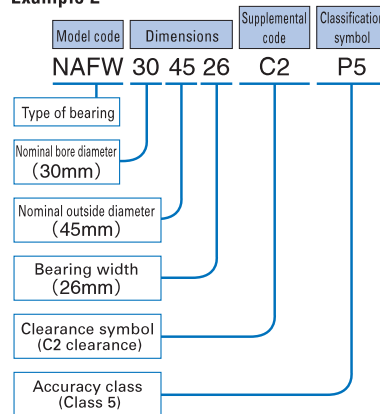

Accuracy

Needle Roller Bearings with Separable Cage are manufactured to the accuracy based on JIS (See page A31.). Tolerances for the smallest single roller set bore diameter of bearings without inner ring are based on Table 14 on page A33.

Clearance

Radial internal clearances of Needle Roller Bearings with Separable Cage are made to the CN clearance shown in Table 18 on page A37.

Fit

Recommended fits for Needle Roller Bearings with Separable Cage are shown in Tables 21 to 23 on pages A41 and A42.

Lubrication

Needle Roller Bearings with Separable Cage are not provided with prepacked grease. Perform proper lubrication for use. Using them without lubrication will increase the wear of the rolling contact surfaces and shorten their lives.

Oil Hole

The double-row type outer rings have both an oil hole and an oil groove, but the single-row type outer rings do not. When outer rings with an oil hole are required, attach "-OH" before the clearance symbol in the identification number, and when outer rings with both an oil hole and an oil groove are required, attach "-OG" to the same position.

Example: NAF 203517 - OH C2 P6

Operating temperature range

For synthetic resin cages, "N" is added at the end of the identification number. The operating temperature range for Needle Roller Bearings with Separable Cage is -20~+120°C. However, the maximum allowable temperature for synthetic resin cages is +110°C, and when they are continuously operated, it is +100°C.

Mounting

Mounting examples of Needle Roller Bearings with Separable Cage are shown in Fig.1.

When mounting Needle Roller Bearings with Separable Cage, it is necessary to locate the needle cage axially. The needle cage is guided by shoulders of the shaft and housing or by side plates, and their guide surfaces must be heat-treated and finished by grinding at right angles to the shaft central axis. Dimensions related to mounting are shown in the table of dimensions.

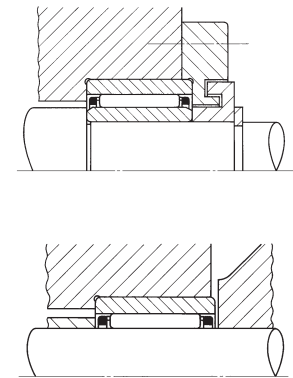

Fig.1 Mounting examples

NEEDLE ROLLER BEARINGS WITH SEPARABLE CAGE

Without Inner Ring



Shaft dia. 5 – 18mm

Shaft dia. mm	Identification number	Mass (Ref.) g	Boundary dimensions mm				Standard mounting dimensions mm			Basic dynamic load rating <i>C</i> N	Basic static load rating <i>C</i> ₀ N
			<i>F</i> _w	<i>D</i>	<i>C</i>	<i>r</i> _{s min} ⁽¹⁾	<i>d</i> _b	<i>D</i> _a Max.	<i>D</i> _b		
5	RNAF 5108N	2.8	5	10	8	0.2	6.7	8.4	5.4	2 420	1 950
6	RNAF 6138N	5.5	6	13	8	0.3	8.4	11	6.4	2 700	2 320
7	RNAF 7148N	6.1	7	14	8	0.3	9.4	12	7.4	2 960	2 690
8	RNAF 81510	8.2	8	15	10	0.3	10.4	13	8.4	3 630	3 600
	RNAFW 81620	20.5	8	16	20	0.3	10.8	14	8.4	6 220	7 200
10	RNAF 101710	9.6	10	17	10	0.3	12.4	15	10.4	4 160	4 550
	RNAF 102012	18.7	10	20	12	0.3	13.5	18	10.4	5 940	6 000
12	RNAF 122212	19.5	12	22	12	0.3	15.5	20	12.4	9 030	8 460
14	RNAF 142213	18.7	14	22	13	0.3	17.6	20	14.6	7 860	9 410
	RNAFW 142220	28.5	14	22	20	0.3	17.6	20	14.6	10 800	14 200
	RNAF 142612	29	14	26	12	0.3	19.4	24	14.6	9 790	9 680
15	RNAF 152313	19.7	15	23	13	0.3	18.6	21	15.6	8 250	10 200
	RNAFW 152320	30.5	15	23	20	0.3	18.6	21	15.6	11 400	15 400
16	RNAF 162413	21	16	24	13	0.3	19.6	22	16.6	8 620	11 000
	RNAFW 162420	32	16	24	20	0.3	19.6	22	16.6	11 900	16 700
	RNAF 162812	31.5	16	28	12	0.3	21.4	26	16.6	10 500	10 900
17	RNAF 172513	22	17	25	13	0.3	20.6	23	17.6	8 980	11 800
	RNAFW 172520	33.5	17	25	20	0.3	20.6	23	17.6	12 400	17 900
18	RNAF 182613	23	18	26	13	0.3	21.6	24	18.6	9 330	12 700
	RNAFW 182620	35	18	26	20	0.3	21.6	24	18.6	12 900	19 100
	RNAF 183012	34.5	18	30	12	0.3	23.4	28	18.6	11 800	13 100
	RNAFW 183024	69.5	18	30	24	0.3	23.4	28	18.6	20 200	26 200

Notes⁽¹⁾ Minimum allowable value of chamfer dimension *r*

⁽²⁾ Allowable rotational speed applies to oil lubrication. For grease lubrication, a maximum of 50% of this value is allowable.

Remarks 1. The character "N" at the end of the identification number indicates that a synthetic resin cage is incorporated.

2. RNAF has no oil hole. RNAFW is provided with an oil groove and an oil hole on the outer ring.

3. No grease is prepacked. Perform proper lubrication.

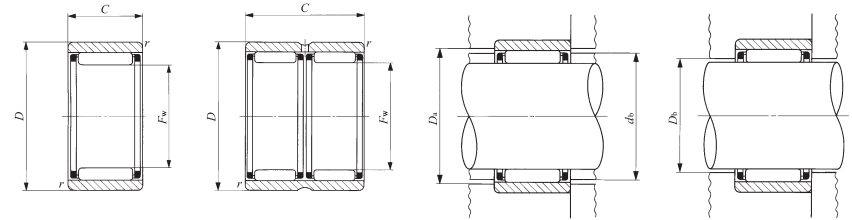

RNAF

RNAFW

Allowable rotational speed ⁽²⁾ rpm
85 000
75 000
65 000
60 000
60 000
50 000
50 000
40 000
35 000
35 000
35 000
35 000
35 000
30 000
30 000
30 000
30 000
30 000
30 000
30 000
30 000
30 000
30 000

1N=0.102kgf=0.2248lbs.

1mm=0.03937inch

NEEDLE ROLLER BEARINGS WITH SEPARABLE CAGE

Without Inner Ring



Shaft dia. 20 – 40mm

Shaft dia. mm	Identification number	Mass (Ref.) g	Boundary dimensions mm				Standard mounting dimensions mm			Basic dynamic load rating <i>C</i> N	Basic static load rating <i>C</i> ₀ N
			<i>F_w</i>	<i>D</i>	<i>C</i>	<i>r_s</i> ⁽¹⁾ mm	<i>d_b</i>	<i>D_a</i> Max.	<i>D_b</i>		
20	RNAF 202813	25	20	28	13	0.3	23.6	26	20.6	9 590	13 500
	RNAFW 202826	49.5	20	28	26	0.3	23.6	26	20.6	16 400	27 100
	RNAF 203212	37.5	20	32	12	0.3	25.4	30	20.6	12 400	14 300
	RNAFW 203224	75	20	32	24	0.3	25.4	30	20.6	21 200	28 600
22	RNAF 223013	27	22	30	13	0.3	25.6	28	22.6	10 200	15 200
	RNAFW 223026	53.5	22	30	26	0.3	25.6	28	22.6	17 500	30 300
	RNAF 223516	58.5	22	35	16	0.3	27.8	33	22.6	17 600	20 900
	RNAFW 223532	117	22	35	32	0.3	27.8	33	22.6	30 200	41 800
25	RNAF 253517	51	25	35	17	0.3	29.5	33	25.6	17 300	26 600
	RNAFW 253526	78	25	35	26	0.3	29.5	33	25.6	22 400	37 200
	RNAF 253716	57	25	37	16	0.3	30.4	35	25.6	19 400	24 500
	RNAFW 253732	114	25	37	32	0.3	30.4	35	25.6	33 200	49 000
28	RNAF 284016	62.5	28	40	16	0.3	33.4	38	28.6	20 100	26 500
	RNAFW 284032	125	28	40	32	0.3	33.4	38	28.6	34 400	53 000
30	RNAF 304017	59	30	40	17	0.3	34.5	38	30.6	18 700	31 100
	RNAFW 304026	90.5	30	40	26	0.3	34.5	38	30.6	24 200	43 400
	RNAF 304216	66	30	42	16	0.3	35.4	40	30.6	20 800	28 400
	RNAFW 304232	132	30	42	32	0.3	35.4	40	30.6	35 700	56 800
35	RNAF 354517	67.5	35	45	17	0.3	39.5	43	35.6	20 500	36 900
	RNAFW 354526	103	35	45	26	0.3	39.5	43	35.6	26 600	51 500
	RNAF 354716	75.5	35	47	16	0.3	40.4	45	35.6	23 100	33 900
	RNAFW 354732	151	35	47	32	0.3	40.4	45	35.6	39 500	67 800
40	RNAF 405017	76	40	50	17	0.3	43.5	48	40.8	22 200	42 700
	RNAFW 405034	152	40	50	34	0.3	43.5	48	40.8	38 000	85 400
	RNAF 405520	140	40	55	20	0.3	45.2	53	40.8	31 400	48 000
	RNAFW 405540	280	40	55	40	0.3	45.2	53	40.8	53 900	96 000

Notes⁽¹⁾ Minimum allowable value of chamfer dimension *r*
⁽²⁾ Allowable rotational speed applies to oil lubrication. For grease lubrication, a maximum of 50% of this value is allowable.
 Remarks1. RNAF has no oil hole. RNAFW is provided with an oil groove and an oil hole on the outer ring.
 2. No grease is prepacked. Perform proper lubrication.

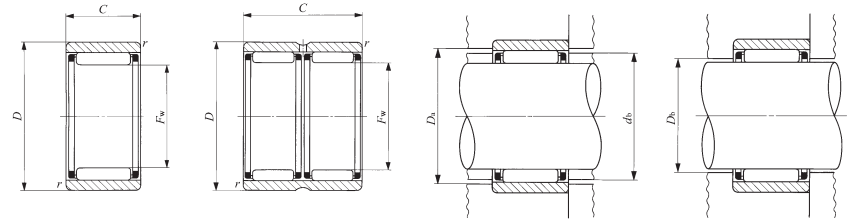

RNAF

RNAFW

Allowable rotational speed ⁽²⁾ rpm	Basic dynamic load rating <i>C</i> N	Basic static load rating <i>C</i> ₀ N
25 000	9 590	13 500
25 000	16 400	27 100
25 000	12 400	14 300
25 000	21 200	28 600
25 000	10 200	15 200
25 000	17 500	30 300
25 000	17 600	20 900
25 000	30 200	41 800
20 000	17 300	26 600
20 000	22 400	37 200
20 000	19 400	24 500
20 000	33 200	49 000
18 000	20 100	26 500
18 000	34 400	53 000
17 000	18 700	31 100
17 000	24 200	43 400
17 000	20 800	28 400
17 000	35 700	56 800
14 000	20 500	36 900
14 000	26 600	51 500
14 000	23 100	33 900
14 000	39 500	67 800
12 000	22 200	42 700
12 000	38 000	85 400
12 000	31 400	48 000
12 000	53 900	96 000

1N=0.102kgf=0.2248lbs.
 1mm=0.03937inch

EEDLE ROLLER BEARINGS WITH SEPARABLE CAGE

Without Inner Ring



Shaft dia. 45 – 100mm

Shaft dia. mm	Identification number	M ss (Ref.) g	Boundary dimensions mm				Standard mounting dimensions mm			Basic dynamic load rating C N	Basic static load rating C ₀ N
			F _w	D	C	r _{s min} ⁽¹⁾	d _b	D _a M x.	D _b		
45	RNAF 455517	83.5	45	55	17	0.3	48.5	53	45.8	23 300	47 100
	RNAFW 455534	167	45	55	34	0.3	48.5	53	45.8	39 900	94 200
	RNAF 456220	184	45	62	20	0.3	50.9	60	45.8	33 200	53 300
	RNAFW 456240	370	45	62	40	0.3	50.9	60	45.8	56 900	107 000
50	RNAF 506220	138	50	62	20	0.3	54.2	60	50.8	27 100	59 300
	RNAFW 506240	275	50	62	40	0.3	54.2	60	50.8	46 400	119 000
	RNAF 506520	170	50	65	20	0.3	55.2	63	50.8	35 900	61 100
	RNAFW 506540	340	50	65	40	0.6	55.2	61	50.8	61 500	122 000
55	RNAF 556820	167	55	68	20	0.3	59.5	66	55.8	28 600	66 000
	RNAFW 556840	335	55	68	40	0.3	59.5	66	55.8	49 000	132 000
	RNAF 557220	220	55	72	20	1	60.9	67	55.8	37 400	66 400
	RNAFW 557240	440	55	72	40	1	60.9	67	55.8	64 100	133 000
60	RNAF 607820	255	60	78	20	1	66.3	73	60.8	38 900	71 700
	RNAFW 607840	510	60	78	40	1	66.3	73	60.8	66 700	143 000
65	RNAF 658530	470	65	85	30	1.5	72	77	66	59 300	127 000
	RNAFW 658560	945	65	85	60	1.5	72	77	66	102 000	255 000
70	RNAF 709030	500	70	90	30	1.5	77	82	71	61 200	136 000
	RNAFW 709060	1 000	70	90	60	1.5	77	82	71	105 000	272 000
75	RNAF 759530	530	75	95	30	1.5	82	87	76	63 100	144 000
	RNAFW 759560	1 060	75	95	60	1.5	82	87	76	108 000	289 000
80	RNAF 8010030	560	80	100	30	1.5	87	92	81	65 000	153 000
	RNAFW 8010060	1 120	80	100	60	1.5	87	92	81	111 000	306 000
85	RNAF 8510530	590	85	105	30	1.5	92	97	86	66 600	161 000
90	RNAF 9011030	625	90	110	30	1.5	97	102	91	69 600	174 000
95	RNAF 9511530	655	95	115	30	1.5	102	107	96	70 900	182 000
100	RNAF 10012030	685	100	120	30	1.5	107	112	101	72 500	191 000

Notes⁽¹⁾ Minimum allowable value of chamfer dimension r

⁽²⁾ Allowable rotational speed applies to oil lubrication. For grease lubrication, a maximum of 50% of this value is allowable.

Remarks1. RNAF has no oil hole. RNAFW is provided with an oil groove and an oil hole on the outer ring.
2. No grease is prepacked. Perform proper lubrication.

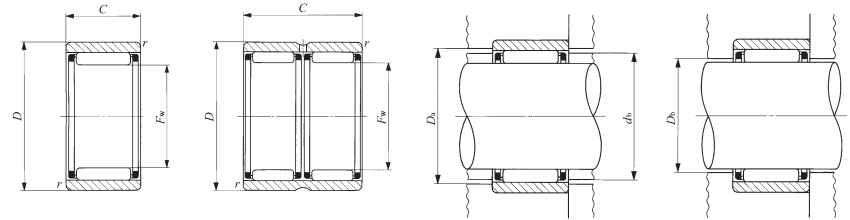

NAF

RNAFW

Allowable rotational speed ⁽²⁾ rpm
11 000
11 000
11 000
11 000
10 000
10 000
10 000
10 000
9 000
9 000
9 000
9 000
8 500
8 500
7 500
7 500
7 000
7 000
6 500
6 500
6 000
6 000
6 000
5 500
5 500
4 500

1N=0.102kgf=0.2248lbs.

1mm=0.03937inch

NEEDLE ROLLER BEARINGS WITH SEPARABLE CAGE

With Inner Ring



Shaft dia. 6 – 25mm

Shaft dia. mm	Identification number	Mass (Ref.) g	Boundary dimensions mm					Standard mounting dimensions mm				
			d	D	C	$r_{s \min}^{(1)}$	F_w	d_b	D_a Max.	d_a Min. Max.	D_b	
6	NAF 61710	13.5	6	17	10	0.3	10	12.4	15	8	9.7	10.4
7	NAF 72012	22.5	7	20	12	0.3	10	13.5	18	9	9.7	10.4
9	NAF 92212	24	9	22	12	0.3	12	15.5	20	11	11.5	12.4
10	NAF 102213	26	10	22	13	0.3	14	17.6	20	12	13	14.6
	NAFW 102220	40	10	22	20	0.3	14	17.6	20	12	13	14.6
	NAF 102612	36	10	26	12	0.3	14	19.4	24	12	13	14.6
12	NAF 122413	29.5	12	24	13	0.3	16	19.6	22	14	15	16.6
	NAFW 122420	45.5	12	24	20	0.3	16	19.6	22	14	15	16.6
	NAF 122812	40	12	28	12	0.3	16	21.4	26	14	15	16.6
15	NAF 152813	38.5	15	28	13	0.3	20	23.6	26	17	19	20.6
	NAFW 152826	77.5	15	28	26	0.3	20	23.6	26	17	19	20.6
	NAF 153212	50.5	15	32	12	0.3	20	25.4	30	17	19	20.6
17	NAF 173013	42.5	17	30	13	0.3	22	25.6	28	19	21	22.6
	NAFW 173026	84.5	17	30	26	0.3	22	25.6	28	19	21	22.6
	NAF 173516	77.5	17	35	16	0.3	22	27.8	33	19	21	22.6
	NAFW 173532	155	17	35	32	0.3	22	27.8	33	19	21	22.6
20	NAF 203517	74	20	35	17	0.3	25	29.5	33	22	24	25.6
	NAFW 203526	114	20	35	26	0.3	25	29.5	33	22	24	25.6
	NAF 203716	79	20	37	16	0.3	25	30.4	35	22	24	25.6
	NAFW 203732	158	20	37	32	0.3	25	30.4	35	22	24	25.6
25	NAF 254017	87.5	25	40	17	0.3	30	34.5	38	27	29	30.6
	NAFW 254026	135	25	40	26	0.3	30	34.5	38	27	29	30.6
	NAF 254216	94	25	42	16	0.3	30	35.4	40	27	29	30.6
	NAFW 254232	186	25	42	32	0.3	30	35.4	40	27	29	30.6

Notes⁽¹⁾ Minimum allowable value of chamfer dimension r

⁽²⁾ Allowable rotational speed applies to oil lubrication. For grease lubrication, a maximum of 50% of this value is allowable.

Remarks1. RNAF has no oil hole. RNAFW is provided with an oil groove and an oil hole on the outer ring.
2. No grease is prepacked. Perform proper lubrication.

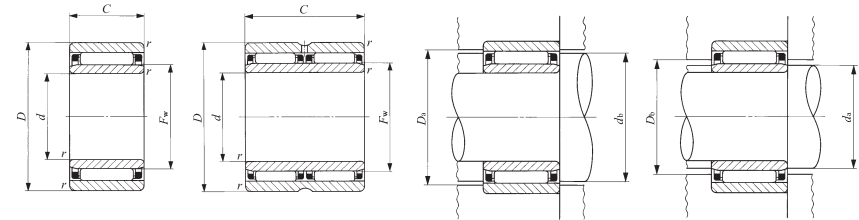

NAF

NAFW

Basic dynamic load rating C N	Basic static load rating C_0 N	Allowable rotational speed ⁽²⁾ rpm	Assembled inner ring
4 160	4 550	50 000	LRT 61010
5 940	6 000	50 000	LRT 71012-1
9 030	8 460	40 000	LRT 91212
7 860	9 410	35 000	LRT 101413
10 800	14 200	35 000	LRT 101420
9 790	9 680	35 000	LRT 101412
8 620	11 000	30 000	LRT 121613
11 900	16 700	30 000	LRT 121620
10 500	10 900	30 000	LRT 121612
9 590	13 500	25 000	LRT 152013
16 400	27 100	25 000	LRT 152026
12 400	14 300	25 000	LRT 152012
10 200	15 200	25 000	LRT 172213
17 500	30 300	25 000	LRT 172226
17 600	20 900	25 000	LRT 172216
30 200	41 800	25 000	LRT 172232
17 300	26 600	20 000	LRT 202517
22 400	37 200	20 000	LRT 202526
19 400	24 500	20 000	LRT 202516
33 200	49 000	20 000	LRT 202532
18 700	31 100	17 000	LRT 253017
24 200	43 400	17 000	LRT 253026
20 800	28 400	17 000	LRT 253016
35 700	56 800	17 000	LRT 253032

1N=0.102kgf=0.2248lbs.
1mm=0.03937inch

NEEDLE ROLLER BEARINGS WITH SEPARABLE CAGE

With Inner Ring



Shaft dia. 30 – 65mm

Shaft dia. mm	Identification number	Mass (Ref.) g	Boundary dimensions mm					Standard mounting dimensions mm				
			<i>d</i>	<i>D</i>	<i>C</i>	$r_s^{(1)}$ min	F_w	d_b	D_a Max.	d_a Min. Max.		D_b
30	NAF 304517	101	30	45	17	0.3	35	39.5	43	32	34	35.6
	NAFW 304526	155	30	45	26	0.3	35	39.5	43	32	34	35.6
	NAF 304716	107	30	47	16	0.3	35	40.4	45	32	34	35.6
	NAFW 304732	215	30	47	32	0.3	35	40.4	45	32	34	35.6
35	NAF 355017	115	35	50	17	0.3	40	43.5	48	37	39	40.8
	NAFW 355034	230	35	50	34	0.3	40	43.5	48	37	39	40.8
	NAF 355520	186	35	55	20	0.3	40	45.2	53	37	39	40.8
	NAFW 355540	375	35	55	40	0.3	40	45.2	53	37	39	40.8
40	NAF 405517	128	40	55	17	0.3	45	48.5	53	42	44	45.8
	NAFW 405534	255	40	55	34	0.3	45	48.5	53	42	44	45.8
	NAF 406220	235	40	62	20	0.3	45	50.9	60	42	44	45.8
	NAFW 406240	475	40	62	40	0.3	45	50.9	60	42	44	45.8
45	NAF 456220	196	45	62	20	0.3	50	54.2	60	47	49	50.8
	NAFW 456240	390	45	62	40	0.3	50	54.2	60	47	49	50.8
	NAF 457220	340	45	72	20	1	55	60.9	67	50	54	55.8
	NAFW 457240	685	45	72	40	1	55	60.9	67	50	54	55.8
50	NAF 506820	230	50	68	20	0.3	55	59.5	66	52	54	55.8
	NAFW 506840	465	50	68	40	0.3	55	59.5	66	52	54	55.8
	NAF 507820	390	50	78	20	1	60	66.3	73	55	59	60.8
	NAFW 507840	775	50	78	40	1	60	66.3	73	55	59	60.8
55	NAF 558530	690	55	85	30	1.5	65	72	77	63	63.5	66
	NAFW 558560	1 380	55	85	60	1.5	65	72	77	63	63.5	66
60	NAF 609030	740	60	90	30	1.5	70	77	82	68	68.5	71
	NAFW 609060	1 480	60	90	60	1.5	70	77	82	68	68.5	71
65	NAF 659530	790	65	95	30	1.5	75	82	87	73	73.5	76
	NAFW 659560	1 580	65	95	60	1.5	75	82	87	73	73.5	76

Notes⁽¹⁾ Minimum allowable value of chamfer dimension *r*

⁽²⁾ Allowable rotational speed applies to oil lubrication. For grease lubrication, a maximum of 50% of this value is allowable.

Remarks1. RNAF has no oil hole. RNAFW is provided with an oil groove and an oil hole on the outer ring.

2. No grease is prepacked. Perform proper lubrication.

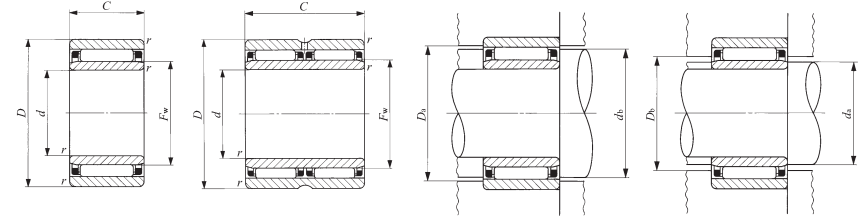

NAF			NAFW	
Basic dynamic load rating <i>C</i>	Basic static load rating <i>C</i> ₀	Allowable rotational speed ⁽²⁾	Assembled inner ring	
N	N	rpm		
20 500	36 900	14 000	LRT 303517	
26 600	51 500	14 000	LRT 303526	
23 100	33 900	14 000	LRT 303516	
39 500	67 800	14 000	LRT 303532	
22 200	42 700	12 000	LRT 354017	
38 000	85 400	12 000	LRT 354034	
31 400	48 000	12 000	LRT 354020	
53 900	96 000	12 000	LRT 354040	
23 300	47 100	11 000	LRT 404517	
39 900	94 200	11 000	LRT 404534	
33 200	53 300	11 000	LRT 404520	
56 900	107 000	11 000	LRT 404540	
27 100	59 300	10 000	LRT 455020	
46 400	119 000	10 000	LRT 455040	
37 400	66 400	9 000	LRT 455520	
64 100	133 000	9 000	LRT 455540	
28 600	66 000	9 000	LRT 505520	
49 000	132 000	9 000	LRT 505540	
38 900	71 700	8 500	LRT 506020	
66 700	143 000	8 500	LRT 506040	
59 300	127 000	7 500	LRT 556530	
102 000	255 000	7 500	LRT 556560	
61 200	136 000	7 000	LRT 607030	
105 000	272 000	7 000	LRT 607060	
63 100	144 000	6 500	LRT 657530	
108 000	289 000	6 500	LRT 657560	

1N=0.102kgf=0.2248lbs.
1mm=0.03937inch

NEEDLE ROLLER BEARINGS WITH SEPARABLE CAGE

With Inner Ring



Shaft dia. 70 – 90mm

Shaft dia. mm	Identification number	Mass (Ref.) g	Boundary dimensions mm					Standard mounting dimensions mm				
			d	D	C	$r_s^{(1)}$ min	F_w	d_b	D_a Max.	d_a Min. Max.	D_b	
70	NAF 7010030	835	70	100	30	1.5	80	87	92	78	78.5	81
	NAFW 7010060	1 680	70	100	60	1.5	80	87	92	78	78.5	81
75	NAF 7510530	885	75	105	30	1.5	85	92	97	83	83.5	86
80	NAF 8011030	935	80	110	30	1.5	90	97	102	88	88.5	91
85	NAF 8511530	985	85	115	30	1.5	95	102	107	93	93.5	96
90	NAF 9012030	1 040	90	120	30	1.5	100	107	112	98	98.5	101

Notes⁽¹⁾ Minimum allowable value of chamfer dimension r

⁽²⁾ Allowable rotational speed applies to oil lubrication. For grease lubrication, a maximum of 50% of this value is allowable.

Remarks 1. RNAF has no oil hole. RNAFW is provided with an oil groove and an oil hole on the outer ring.
2. No grease is prepacked. Perform proper lubrication.

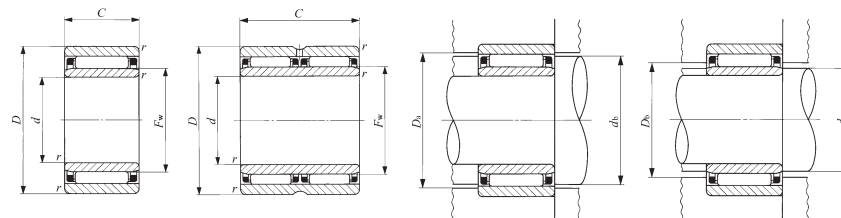

NAF

NAFW

Basic dynamic load rating C	Basic static load rating C_0	Allowable rotational speed ⁽²⁾	Assembled inner ring
N	N	rpm	
65 000	153 000	6 000	LRT 708030-1
111 000	306 000	6 000	LRT 708060
66 600	161 000	6 000	LRT 758530-1
69 600	174 000	5 500	LRT 809030-1
70 900	182 000	5 500	LRT 859530
72 500	191 000	4 500	LRT 9010030

1N=0.102kgf=0.2248lbs.

1mm=0.03937inch

ROLLER BEARINGS

- Caged Roller Bearings
- Full Complement Roller Bearings
- Roller Bearings for Sheaves



Structures of Roller Bearings

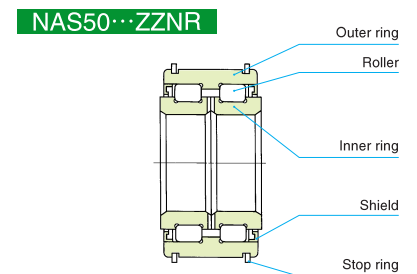
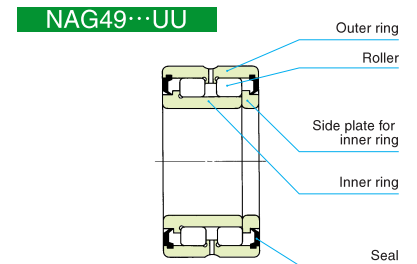
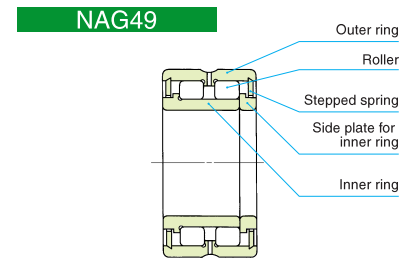
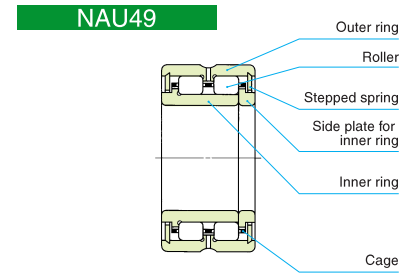

E

NAG
NAU
TRU
NAS

Types

The types of Roller Bearings shown in Table 1 are available.

Table 1 Type of bearing

Type	Caged type	Full complement type	For sheaves
Standard	NAU49 TRU	NAG49	—
With seal	NAU49...UU TRU...UU	NAG49...UU	NAS50...UUNR
With shield	—	—	NAS50...ZZNR

Caged Roller Bearings

These bearings are suitable for high-speed rotations and fluctuating loads. Also, as the axial distance between the double-row rollers is comparatively large, large moment loads can be supported.

Caged roller bearings with seal incorporate seals on both sides. Synthetic resin rubber seals are excellent in the prevention of dust penetration and grease leakage, providing an excellent sealing effect.

Full Complement Roller Bearings

These bearings are suitable for low-speed rotations or oscillating motions and heavy loads. Similar to the caged type, the structure is advantageous for supporting moment loads.

The bearings with seal incorporate seals on both sides.

Roller Bearings for Sheaves

These bearings are the double-row full complement type with a low sectional height designed for use in sheaves. There are two types; the sealed type and the shield type. They can withstand heavy radial loads and shock loads at comparatively low-speed rotations, and can also withstand axial loads.

They can easily be fixed axially to sheaves using the stop rings of the outer ring. As the width of the inner ring is designed to be larger than that of the outer ring, they require no spacer between sheaves. The structure is stable because the double-row rollers can withstand the moment loads caused by rope transition.

The surfaces of these bearings are treated to have high corrosion resistance.

Identification Number

The identification number of Roller Bearings consists of a model code, dimensions, any supplemental codes and a classification symbol. The arrangement examples are shown below.

Examples of identification number

Example 1

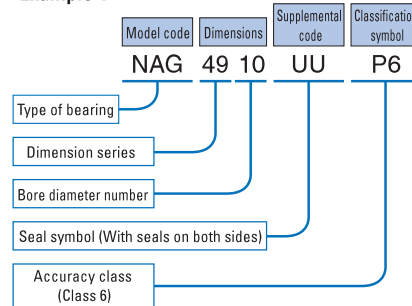

Example 2

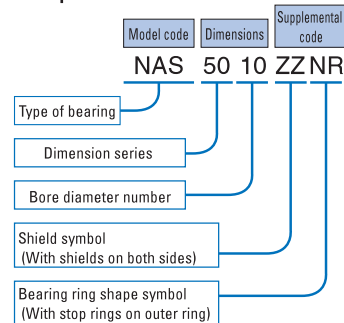

Accuracy

Roller Bearings are manufactured in accordance with JIS (See page A31.). A side plate for inner ring is assembled on one side of caged or full complement roller bearings. The tolerance of bore diameter of the side plate is shown below. Tolerances of Roller Bearings for Sheaves represent the values before surface treatment. The tolerance of internal distance between cir-clips is shown below.

Tolerance of bore diameter of the side plate d : E7
Tolerance of internal distance between cir-clips C_1 : 0~+0.4mm

Clearance

Roller Bearings are manufactured to the CN clearance shown in Table 18 on page A37. However, Roller Bearings for Sheaves are manufactured so that proper operating clearances are obtained after being mounted with a specified fit.

Fit

The recommended fits for Roller Bearings are shown in Tables 21 to 22 on pages A41 and A42. The recommended fits for Roller Bearings for Sheaves are shown in Table 2.

Table 2 Recommended fits for Roller Bearings for Sheaves

Tolerance class of shaft	Tolerance class of housing bore
g6	N7

Table 3 Bearings with prepacked grease

○ : With prepacked grease × : Without prepacked grease

Type	Standard	With seals	With shields
Caged type	NAU, TRU	×	○
Full complement type	NAG	×	○
For sheaves	NAS	—	○

Table 4 Number of oil holes of the inner ring and outer ring

Type	Nominal bore diameter d mm	Number of oil holes of the outer ring			Number of oil holes of the inner ring
		Standard	With seals	With shields	
Caged type	$d \leq 17$	0	0	—	0
	$17 < d$	2	2		
Full complement type	$d \leq 17$	0	0	—	0
	$17 < d$	2	2		
For sheaves	NAS	—	0	0	2

Remark The bearings with oil holes are also provided with an oil groove.

1N=0.102kgf=0.2248lbs.
1mm=0.03937inch

Lubrication

Bearings with prepacked grease are shown in Table 3. For Caged Roller Bearings and Full Complement Roller Bearings, ALVANIA GREASE S2 (SHELL) is prepacked as the lubricating grease. For Roller Bearings for Sheaves, ALVANIA GREASE EP2 (SHELL) is prepacked as the lubricating grease.

In the case of bearings without prepacked grease, perform proper lubrication for use. Operating without lubrication will increase the wear of the rolling contact surfaces and shorten their lives.

Oil Hole

The number of oil holes of the inner and outer rings is shown in Table 4.

Operating Temperature Range

The operating temperature range for Roller Bearings is $-20^{\circ}\text{C} \sim +120^{\circ}\text{C}$. However, the maximum allowable temperature for Roller Bearings for Sheaves is $+110^{\circ}\text{C}$.

Axial Load Capacity

Axial load capacity is not determined from the basic dynamic load rating based on rolling fatigue, but is determined by the amount of heat generated by sliding contact between the ends of rollers and guide shoulders of the inner and outer rings. It is therefore limited by the load conditions, sliding speeds, lubrication methods, etc.

The axial load capacity of Roller Bearings is obtained from the following equation.

If the axial load increases in comparison with the radial load, it will start to interfere with the smooth rolling motion. The axial load should therefore be within 20% of the radial load.

$$C_A = f_v a f_A \dots\dots\dots(1)$$

where, C_A : Axial load capacity N

f_v : Speed correction factor

f_v is obtained from Fig.2 by calculating the $d_m n$ value.

$$d_m n = d_m \times n$$

d_m : Mean value of bearing bore and outside diameters mm

$$\left(d_m = \frac{d + D}{2} \right)$$

n : Rotational speed rpm

When $d_m n \leq 1000$, $f_v = 1$.

a : Value determined by type of bearing (See Table 5.)

f_A : Axial load capacity factor (See Fig.1.)

Table 5 Value by type of bearing

Type of bearing	a
NAS 50	1
NAG 49	0.78
NAU 49, TRU	0.7

Calculation example

When a roller bearing for sheaves NAS 5016 ZZ NR is run at $n = 250$ rpm under grease lubrication and subjected to an intermittent axial load, the axial load capacity is calculated as follows.

As the bearing bore diameter is 80 mm, $f_A = 18000$ is obtained from the axial load capacity line of Fig. 1 (ii).

$$a = 1$$

$$d_m = \frac{80 + 125}{2} = 102.5$$

$$d_m n = 102.5 \times 250 = 25600$$

From Fig. 2, $f_v = 0.87$

Therefore, the axial load capacity C_A is obtained.

$$C_A = f_v a f_A = 0.87 \times 1 \times 18000 = 15700 \text{ N}$$

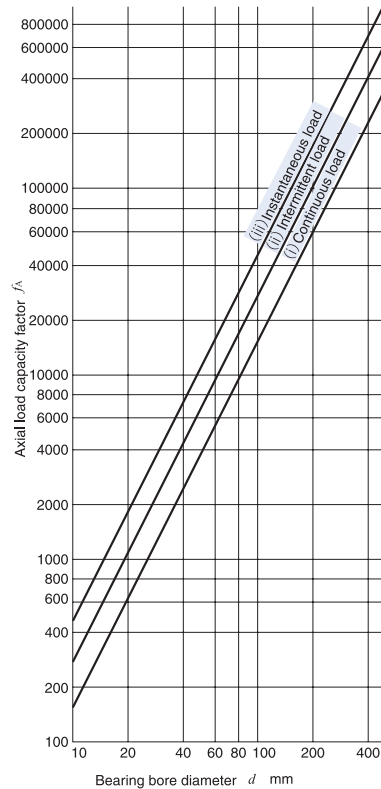

Fig. 1 Axial load capacity factor

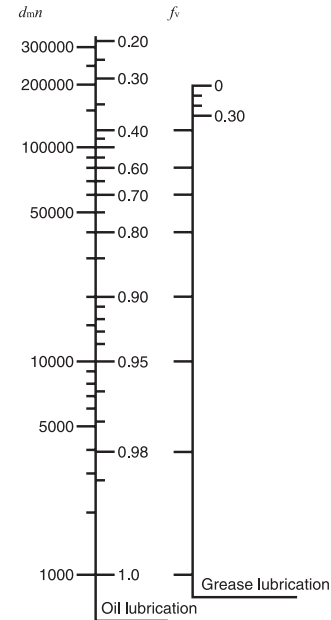

Fig. 2 Speed correction factor

Mounting

Unlike needle roller bearings, Caged and Full Complement Roller Bearings are non-separable.

As shown in Fig. 3 (1), the inner ring should be press-fitted until it makes close contact with the shaft shoulder, and fixed axially with a nut. Dimensions of the shoulders of the shaft and housing should be based on J and E_W shown in the table of dimensions, respectively.

In the case of Roller Bearings for Sheaves, as shown in Fig. 3 (2), the outer ring should be fixed by stop rings after being press-fitted into the sheaves, and the inner ring should be fixed securely in the axial direction.

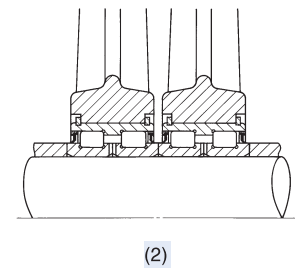
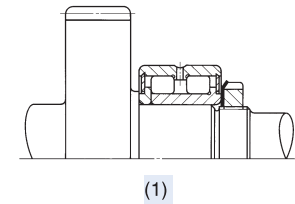
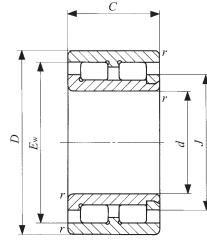

Fig. 3 Mounting examples

1N=0.102kgf=0.2248lbs.
1mm=0.03937inch

ROLLER BEARINGS

Caged Roller Bearings
Full Complement Roller Bearings



NAG49
($d \leq 17$)

Shaft dia. 10 – 35mm

Shaft dia. mm	Identification number			Mass (Ref.) g	Boundary dimensions mm					
	Full complement type	Caged type			d	D	C	$r_{s \min}^{(1)}$	J	E_w
10	NAG 4900	—	—	25.5	10	22	13	0.3	15.5	18.5
	—	NAU 4900	—	24.5	10	22	13	0.3	15.5	18.5
12	NAG 4901	—	—	28.5	12	24	13	0.3	17	20
	—	NAU 4901	—	27.5	12	24	13	0.3	17	20
15	NAG 4902	—	—	38	15	28	13	0.3	21	24
	—	NAU 4902	—	36.5	15	28	13	0.3	21	24
	—	—	TRU 153320	80.5	15	33	20	0.3	19.5	27
17	NAG 4903	—	—	41	17	30	13	0.3	22.5	25.5
	—	NAU 4903	—	39.5	17	30	13	0.3	22.5	25.5
	—	—	TRU 173425	100	17	34	25	0.3	21.5	29.5
20	NAG 4904	—	—	76.5	20	37	17	0.3	24	31.5
	—	NAU 4904	—	76	20	37	17	0.3	24	31.5
	—	—	TRU 203820	96.5	20	38	20	0.3	25	32.5
	—	—	TRU 203825	122	20	38	25	0.3	25	32.5
25	NAG 4905	—	—	89.5	25	42	17	0.3	29.5	37
	—	NAU 4905	—	89	25	42	17	0.3	29.5	37
	—	—	TRU 254425	154	25	44	25	0.3	30.5	38
28	—	—	TRU 284530	173	28	45	30	0.3	31.5	39.5
30	NAG 4906	—	—	103	30	47	17	0.3	34	41.5
	—	NAU 4906	—	102	30	47	17	0.3	34	41.5
	—	—	TRU 304830	197	30	48	30	0.3	35	42.5
32	—	—	TRU 325230	260	32	52	30	0.6	38	46
35	NAG 4907	—	—	172	35	55	20	0.6	40	49
	—	NAU 4907	—	168	35	55	20	0.6	40	49
	—	—	TRU 355630	270	35	56	30	0.6	40	49

Notes⁽¹⁾ Minimum allowable value of chamfer dimension r

⁽²⁾ Allowable rotational speed applies to oil lubrication. For grease lubrication, a maximum of 60% of this value is allowable. Considering that the axial load acts under practical operating conditions, up to 1/10 of this value is recommended for actual use.

Remarks1. The NAG and NAU series with a bore diameter d of 17 mm or less have no oil hole. In others, the outer ring has an oil groove and two oil holes.

2. No grease is prepacked. Perform proper lubrication.

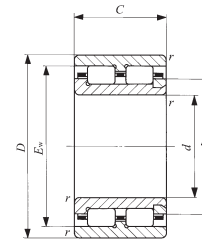

NAU49
($d \leq 17$)

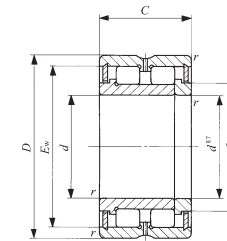

NAG49

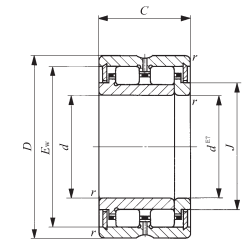

NAU49 TRU

Basic dynamic load rating C	Basic static load rating C_0	Allowable rotational speed ⁽²⁾
N	N	rpm
9 650	10 800	17 000
6 580	6 470	30 000
10 300	12 000	15 000
6 950	7 120	25 000
11 800	15 200	12 000
7 950	9 020	20 000
10 400	10 400	20 000
12 300	16 500	11 000
8 240	9 670	19 000
18 000	21 600	18 000
15 600	18 900	9 500
10 700	11 300	16 000
12 100	13 400	16 000
18 700	23 600	16 000
17 500	23 200	7 500
11 900	13 900	13 000
21 000	28 900	13 000
28 700	43 800	12 000
19 400	27 600	6 500
13 000	16 200	12 000
29 400	46 600	11 000
29 800	44 200	10 000
28 700	43 800	5 500
19 500	26 300	10 000
32 200	49 800	10 000

1N=0.102kgf=0.2248lbs.
1mm=0.03937inch

ROLLER BEARINGS

Caged Roller Bearings
Full Complement Roller Bearings



Shaft dia. 40 – 80mm

Shaft dia. mm	Identification number			Mass (Ref.) g	Boundary dimensions mm					
	Full complement type	Caged type			d	D	C	$r_{s \min}^{(1)}$	J	E_w
40	NAG 4908	—	—	225	40	62	22	0.6	46	56
	—	—	TRU 405930	265	40	59	30	0.6	45	52.5
	—	NAU 4908	—	220	40	62	22	0.6	46	56
42	—	—	TRU 426230	290	42	62	30	0.6	48	56.5
45	NAG 4909	—	—	265	45	68	22	0.6	51	61
	—	—	TRU 456430	295	45	64	30	0.6	50.5	58.5
	—	NAU 4909	—	260	45	68	22	0.6	51	61
50	NAG 4910	—	—	270	50	72	22	0.6	55.5	65.5
	—	NAU 4910	—	265	50	72	22	0.6	55.5	65.5
	—	—	TRU 507745	710	50	77	45	1	58	69
55	NAG 4911	—	—	395	55	80	25	1	61.5	72.5
	—	NAU 4911	—	385	55	80	25	1	61.5	72.5
	—	—	TRU 558138	615	55	81	38	1	61.5	72.5
60	NAG 4912	—	—	425	60	85	25	1	67	77.5
	—	NAU 4912	—	415	60	85	25	1	67	77.5
	—	—	TRU 608945	880	60	89	45	1	69.5	81.5
65	NAG 4913	—	—	455	65	90	25	1	72	83
	—	NAU 4913	—	440	65	90	25	1	72	83
70	NAG 4914	—	—	725	70	100	30	1	79	91.5
	—	NAU 4914	—	705	70	100	30	1	79	91.5
75	NAG 4915	—	—	775	75	105	30	1	83.5	95.5
	—	NAU 4915	—	750	75	105	30	1	83.5	95.5
	—	—	TRU 7510845	1 240	75	108	45	1	85.5	98.5
80	NAG 4916	—	—	815	80	110	30	1	89.5	102
	—	NAU 4916	—	790	80	110	30	1	89.5	102

Notes⁽¹⁾ Minimum allowable value of chamfer dimension r

⁽²⁾ Allowable rotational speed applies to oil lubrication. For grease lubrication, a maximum of 60% of this value is allowable. Considering that the axial load acts under practical operating conditions, up to 1/10 of this value is recommended for actual use.

Remarks1. The outer ring has an oil groove and two oil holes.
2. No grease is prepacked. Perform proper lubrication.

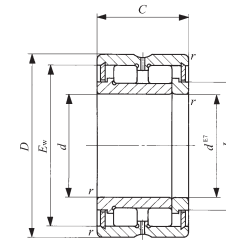

NAG49

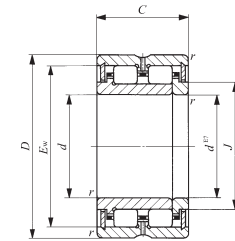

NAU49 TRU

Basic dynamic load rating C	Basic static load rating C_0	Allowable rotational speed ⁽²⁾
N	N	rpm
34 600	49 500	5 000
34 700	62 500	8 500
23 400	29 400	8 500
34 600	57 800	8 000
36 400	54 700	4 500
32 600	59 700	8 000
24 800	32 800	8 000
38 200	59 900	4 000
26 200	36 200	7 000
75 700	134 000	7 000
48 100	77 700	3 500
33 000	47 000	6 500
61 400	104 000	6 500
50 300	84 300	3 500
34 700	51 400	6 000
88 100	152 000	6 000
53 200	93 000	3 000
36 900	57 100	5 500
77 700	139 000	3 000
53 700	84 600	5 000
80 000	146 000	2 500
54 800	88 200	5 000
103 000	190 000	4 500
83 000	157 000	2 500
57 200	95 500	4 500

1N=0.102kgf=0.2248lbs.
1mm=0.03937inch

ROLLER BEARINGS

Caged Roller Bearings
Full Complement Roller Bearings



Shaft dia. 85 – 140mm

Shaft dia. mm	Identification number			Mass (Ref.) g	Boundary dimensions mm					
	Full complement type	Caged type			d	D	C	$r_{s \min}^{(1)}$	J	E_w
85	NAG 4917	—	—	1 190	85	120	35	1.5	96	110
	—	—	TRU 8511850	1 530	85	118	50	1	94.5	107.5
	—	NAU 4917	—	1 150	85	120	35	1.5	96	110
	—	—	TRU 8512045	1 500	85	120	45	1.5	96.5	110
90	NAG 4918	—	—	1 250	90	125	35	1.5	101	115.5
	—	NAU 4918	—	1 210	90	125	35	1.5	101	115.5
	—	—	TRU 9012550	1 740	90	125	50	1.5	101	114
95	NAG 4919	—	—	1 300	95	130	35	1.5	106	120.5
	—	NAU 4919	—	1 270	95	130	35	1.5	106	120.5
100	NAG 4920	—	—	1 850	100	140	40	1.5	114.5	129.5
	—	—	TRU 10013550	1 900	100	135	50	1.5	112	125.5
	—	NAU 4920	—	1 770	100	140	40	1.5	114.5	129.5
105	—	—	TRU 10515350	2 890	105	153	50	1.5	120	138
110	NAG 4922	—	—	2 010	110	150	40	1.5	123	138.5
	—	NAU 4922	—	1 930	110	150	40	1.5	123	138.5
120	NAG 4924	—	—	2 780	120	165	45	1.5	136	153.5
	—	NAU 4924	—	2 680	120	165	45	1.5	136	153.5
125	—	—	TRU 12517860	4 490	125	178	60	1.5	143.5	162
130	NAG 4926	—	—	3 750	130	180	50	2	147	165.5
	—	NAU 4926	—	3 610	130	180	50	2	147	165.5
135	—	—	TRU 13518860	4 790	135	188	60	1.5	154	172.5
140	NAG 4928	—	—	3 990	140	190	50	2	157.5	176
	—	NAU 4928	—	3 840	140	190	50	2	157.5	176

Notes⁽¹⁾ Minimum allowable value of chamfer dimension r

⁽²⁾ Allowable rotational speed applies to oil lubrication. For grease lubrication, a maximum of 60% of this value is allowable. Considering that the axial load acts under practical operating conditions, up to 1/10 of this value is recommended for actual use.

- Remarks1. The outer ring has an oil groove and two oil holes.
2. No grease is prepacked. Perform proper lubrication.

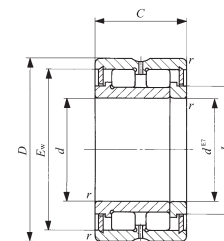

NAG49

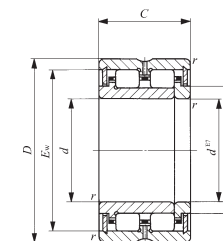

NAU49 TRU

Basic dynamic load rating C	Basic static load rating C_0	Allowable rotational speed ⁽²⁾
N	N	rpm
111 000	200 000	2 500
114 000	222 000	4 000
75 400	120 000	4 000
110 000	215 000	4 000
114 000	211 000	2 500
79 500	130 000	4 000
119 000	240 000	4 000
117 000	222 000	2 000
81 000	136 000	4 000
152 000	292 000	2 000
124 000	264 000	3 500
106 000	181 000	3 500
159 000	286 000	3 500
161 000	322 000	1 900
113 000	200 000	3 500
208 000	431 000	1 700
146 000	268 000	3 000
211 000	408 000	3 000
240 000	495 000	1 600
166 000	304 000	2 500
220 000	442 000	2 500
249 000	531 000	1 500
174 000	327 000	2 500

1N=0.102kgf=0.2248lbs.
1mm=0.03937inch

ROLLER BEARINGS

Caged Roller Bearings **With Seal**

Full Complement Roller Bearings **With Seal**



Shaft dia. 10 – 40mm

Shaft dia. mm	Identification number		Mass (Ref.) g	Boundary dimensions mm				
	Full complement type	Caged type		d	D	C	r_s min ⁽¹⁾	J
10	NAG 4900UU	—	25.5	10	22	13	0.3	15.5
12	NAG 4901UU	—	28.5	12	24	13	0.3	17
15	NAG 4902UU	—	38	15	28	13	0.3	21
		TRU 153320UU	80.5	15	33	20	0.3	19.5
17	NAG 4903UU	—	41	17	30	13	0.3	22.5
		TRU 173425UU	100	17	34	25	0.3	21.5
20	NAG 4904UU	—	76.5	20	37	17	0.3	24
		NAU 4904UU	76	20	37	17	0.3	24
		—	96.5	20	38	20	0.3	25
		TRU 203820UU TRU 203825UU	122	20	38	25	0.3	25
25	NAG 4905UU	—	89.5	25	42	17	0.3	29.5
		NAU 4905UU	89	25	42	17	0.3	29.5
		—	154	25	44	25	0.3	30.5
28	—	—	173	28	45	30	0.3	31.5
30	NAG 4906UU	—	103	30	47	17	0.3	34
		NAU 4906UU	102	30	47	17	0.3	34
		—	197	30	48	30	0.3	35
32	—	—	260	32	52	30	0.6	38
35	NAG 4907UU	—	172	35	55	20	0.6	40
		NAU 4907UU	168	35	55	20	0.6	40
		—	270	35	56	30	0.6	40
40	NAG 4908UU	—	225	40	62	22	0.6	46
		—	265	40	59	30	0.6	45
		NAU 4908UU	220	40	62	22	0.6	46

Notes⁽¹⁾ Minimum allowable value of chamfer dimension r

⁽²⁾ Allowable rotational speed applies to grease lubrication. Considering that the axial load acts under practical operating conditions, up to 1/10 of this value is recommended for actual use.

Remarks 1. The NAG and NAU series with a bore diameter, d , of 17 mm or less have no oil hole. In others, the outer ring has an oil groove and two oil holes.

2. The bearings with seals are provided with prepacked grease.

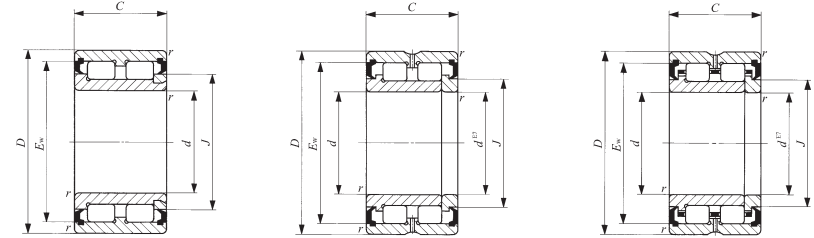

NAG49...UU
($d \leq 17$)

NAG49...UU

NAU49...UU
TRU...UU

E_w	Basic dynamic load rating C	Basic static load rating C_0	Allowable rotational speed ⁽²⁾
	N	N	rpm
19.5	9 650	10 800	10 000
21	10 300	12 000	9 000
25	11 800	15 200	7 000
27	10 400	10 400	9 500
26.5	12 300	16 500	6 500
29.5	18 000	21 600	8 500
31.5	15 600	18 900	5 500
31.5	10 700	11 300	8 000
32.5	12 100	13 400	7 500
32.5	18 700	23 600	7 500
37	17 500	23 200	4 500
37	11 900	13 900	6 500
38	21 000	28 900	6 000
39.5	28 700	43 800	6 000
41.5	19 400	27 600	4 000
41.5	13 000	16 200	5 500
42.5	29 400	46 600	5 500
46	29 800	44 200	5 000
49	28 700	43 800	3 500
49	19 500	26 300	4 500
49	32 200	49 800	4 500
56	34 600	49 500	3 000
52.5	34 700	62 500	4 000
56	23 400	29 400	4 000

1N=0.102kgf=0.2248lbs.

1mm=0.03937inch

ROLLER BEARINGS

Caged Roller Bearings **With Seal**

Full Complement Roller Bearings **With Seal**



Shaft dia. 42 – 80mm

Shaft dia. mm	Identification number			Mass (Ref.) g	Boundary dimensions mm				
	Full complement type	Caged type			<i>d</i>	<i>D</i>	<i>C</i>	<i>r_s</i> min ⁽¹⁾	<i>J</i>
42	—	—	TRU 426230UU	290	42	62	30	0.6	48
45	NAG 4909UU	—	—	265	45	68	22	0.6	51
	—	—	TRU 456430UU	295	45	64	30	0.6	50.5
	—	NAU 4909UU	—	260	45	68	22	0.6	51
50	NAG 4910UU	—	—	270	50	72	22	0.6	55.5
	—	NAU 4910UU	—	265	50	72	22	0.6	55.5
	—	—	TRU 507745UU	710	50	77	45	1	58
55	NAG 4911UU	—	—	395	55	80	25	1	61.5
	—	NAU 4911UU	—	385	55	80	25	1	61.5
	—	—	TRU 558138UU	615	55	81	38	1	61.5
60	NAG 4912UU	—	—	425	60	85	25	1	67
	—	NAU 4912UU	—	415	60	85	25	1	67
	—	—	TRU 608945UU	880	60	89	45	1	69.5
65	NAG 4913UU	—	—	455	65	90	25	1	72
	—	NAU 4913UU	—	440	65	90	25	1	72
70	NAG 4914UU	—	—	725	70	100	30	1	79
	—	NAU 4914UU	—	705	70	100	30	1	79
75	NAG 4915UU	—	—	775	75	105	30	1	83.5
	—	NAU 4915UU	—	750	75	105	30	1	83.5
	—	—	TRU 7510845UU	1 240	75	108	45	1	85.5
80	NAG 4916UU	—	—	815	80	110	30	1	89.5
	—	NAU 4916UU	—	790	80	110	30	1	89.5

Notes⁽¹⁾ Minimum allowable value of chamfer dimension *r*

⁽²⁾ Allowable rotational speed applies to grease lubrication. Considering that the axial load acts under practical operating conditions, up to 1/10 of this value is recommended for actual use.

Remarks1. The outer ring has an oil groove and two oil holes.

2. The bearings with seals are provided with prepacked grease.

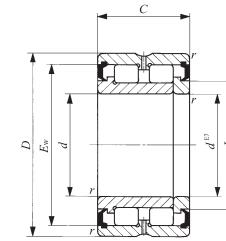

NAG49...UU

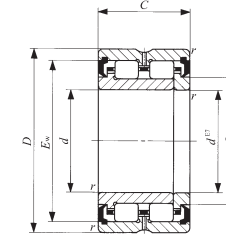

NAU49...UU
TRU...UU

<i>E_w</i>	Basic dynamic load rating <i>C</i>	Basic static load rating <i>C₀</i>	Allowable rotational speed ⁽²⁾
	N	N	rpm
56.5	34 600	57 800	4 000
61	36 400	54 700	2 500
58.5	32 600	59 700	3 500
61	24 800	32 800	3 500
65.5	38 200	59 900	2 500
65.5	26 200	36 200	3 500
69	75 700	134 000	3 500
72.5	48 100	77 700	2 000
72.5	33 000	47 000	3 000
72.5	61 400	104 000	3 000
77.5	50 300	84 300	2 000
77.5	34 700	51 400	3 000
81.5	88 100	152 000	3 000
83	53 200	93 000	1 900
83	36 900	57 100	2 500
91.5	77 700	139 000	1 800
91.5	53 700	84 600	2 500
95.5	80 000	146 000	1 700
95.5	54 800	88 200	2 500
98.5	103 000	190 000	2 000
102	83 000	157 000	1 600
102	57 200	95 500	2 000

1N=0.102kgf=0.2248lbs.
1mm=0.03937inch

ROLLER BEARINGS

Caged Roller Bearings **With Seal**

Full Complement Roller Bearings **With Seal**



Shaft dia. 85 – 140mm

Shaft dia. mm	Identification number			Mass (Ref.) g	Boundary dimensions mm				
	Full complement type	Caged type			d	D	C	$r_s^{(1)}$	J
85	NAG 4917UU	—	—	1 190	85	120	35	1.5	96
	—	—	TRU 8511850UU	1 530	85	118	50	1	94.5
	—	NAU 4917UU	—	1 150	85	120	35	1.5	96
	—	—	TRU 8512045UU	1 500	85	120	45	1.5	96.5
90	NAG 4918UU	—	—	1 250	90	125	35	1.5	101
	—	NAU 4918UU	—	1 210	90	125	35	1.5	101
	—	—	TRU 9012550UU	1 740	90	125	50	1.5	101
95	NAG 4919UU	—	—	1 300	95	130	35	1.5	106
	—	NAU 4919UU	—	1 270	95	130	35	1.5	106
100	NAG 4920UU	—	—	1 850	100	140	40	1.5	114.5
	—	—	TRU 10013550UU	1 900	100	135	50	1.5	112
	—	NAU 4920UU	—	1 770	100	140	40	1.5	114.5
105	—	—	TRU 10515350UU	2 890	105	153	50	1.5	120
110	NAG 4922UU	—	—	2 010	110	150	40	1.5	123
	—	NAU 4922UU	—	1 930	110	150	40	1.5	123
120	NAG 4924UU	—	—	2 780	120	165	45	1.5	136
	—	NAU 4924UU	—	2 680	120	165	45	1.5	136
125	—	—	TRU 12517860UU	4 490	125	178	60	1.5	143.5
130	NAG 4926UU	—	—	3 750	130	180	50	2	147
	—	NAU 4926UU	—	3 610	130	180	50	2	147
135	—	—	TRU 13518860UU	4 790	135	188	60	1.5	154
140	NAG 4928UU	—	—	3 990	140	190	50	2	157.5
	—	NAU 4928UU	—	3 840	140	190	50	2	157.5

Notes⁽¹⁾ Minimum allowable value of chamfer dimension r
⁽²⁾ Allowable rotational speed applies to grease lubrication. Considering that the axial load acts under practical operating conditions, up to 1/10 of this value is recommended for actual use.

Remarks1. The outer ring has an oil groove and two oil holes.
 2. The bearings with seals are provided with prepacked grease.

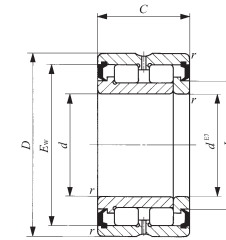

NAG49...UU

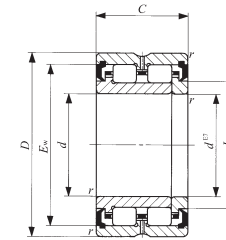

NAU49...UU
TRU...UU

E_w	Basic dynamic load rating C N	Basic static load rating C_0 N	Allowable rotational speed ⁽²⁾ rpm
110	111 000	200 000	1 500
107.5	114 000	222 000	2 000
110	75 400	120 000	2 000
110	110 000	215 000	2 000
115.5	114 000	211 000	1 400
115.5	79 500	130 000	1 900
114	119 000	240 000	1 900
120.5	117 000	222 000	1 300
120.5	81 000	136 000	1 800
129.5	152 000	292 000	1 200
125.5	124 000	264 000	1 700
129.5	106 000	181 000	1 700
138	159 000	286 000	1 600
138.5	161 000	322 000	1 100
138.5	113 000	200 000	1 600
153.5	208 000	431 000	1 000
153.5	146 000	268 000	1 400
162	211 000	408 000	1 400
165.5	240 000	495 000	950
165.5	166 000	304 000	1 300
172.5	220 000	442 000	1 300
176	249 000	531 000	900
176	174 000	327 000	1 200

1N=0.102kgf=0.2248lbs.
1mm=0.03937inch

E

NAG
TAU
NRU
AS

ROLLER BEARINGS

Roller Bearings for Sheaves



Shaft dia. 40 – 170mm

Shaft dia. mm	Identification number		Mass (Ref.) kg	Boundary dimensions mm						
	Sealed type	Shield type		<i>d</i>	<i>D</i>	<i>D</i> ₂	<i>B</i>	<i>C</i>	<i>C</i> ₁	<i>S</i>
40	NAS 5008UUNR	NAS 5008ZZNR	0.55	40	68	71.8	38	37	28	4.5
45	NAS 5009UUNR	NAS 5009ZZNR	0.70	45	75	78.8	40	39	30	4.5
50	NAS 5010UUNR	NAS 5010ZZNR	0.75	50	80	83.8	40	39	30	4.5
55	NAS 5011UUNR	NAS 5011ZZNR	1.15	55	90	94.8	46	45	34	5.5
60	NAS 5012UUNR	NAS 5012ZZNR	1.20	60	95	99.8	46	45	34	5.5
65	NAS 5013UUNR	NAS 5013ZZNR	1.30	65	100	104.8	46	45	34	5.5
70	NAS 5014UUNR	NAS 5014ZZNR	1.90	70	110	114.5	54	53	42	5.5
75	NAS 5015UUNR	NAS 5015ZZNR	2.00	75	115	119.5	54	53	42	5.5
80	NAS 5016UUNR	NAS 5016ZZNR	2.65	80	125	129.5	60	59	48	5.5
85	NAS 5017UUNR	NAS 5017ZZNR	2.80	85	130	134.5	60	59	48	5.5
90	NAS 5018UUNR	NAS 5018ZZNR	3.70	90	140	145.4	67	66	54	6
95	NAS 5019UUNR	NAS 5019ZZNR	3.90	95	145	150.4	67	66	54	6
100	NAS 5020UUNR	NAS 5020ZZNR	4.05	100	150	155.4	67	66	54	6
110	NAS 5022UUNR	NAS 5022ZZNR	6.50	110	170	175.4	80	79	65	7
120	NAS 5024UUNR	NAS 5024ZZNR	6.95	120	180	188.4	80	79	65	7
130	NAS 5026UUNR	NAS 5026ZZNR	10.5	130	200	208.4	95	94	77	8.5
140	NAS 5028UUNR	NAS 5028ZZNR	11.0	140	210	218.4	95	94	77	8.5
150	NAS 5030UUNR	NAS 5030ZZNR	13.5	150	225	233.4	100	99	81	9
160	NAS 5032UUNR	NAS 5032ZZNR	16.5	160	240	248.4	109	108	89	9.5
170	NAS 5034UUNR	NAS 5034ZZNR	22.5	170	260	270	122	121	99	11

Notes⁽¹⁾ Minimum allowable value of chamfer dimension *r*
⁽²⁾ Allowable rotational speed applies to grease lubrication. Considering that the axial load acts under practical operating conditions, up to 1/10 of this value is recommended for actual use.

Remarks1. The inner ring has an oil groove and two oil holes.
 2. Roller Bearings for Sheaves are provided with prepacked grease.

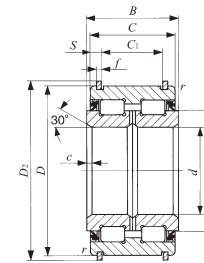

NAS50...UUNR

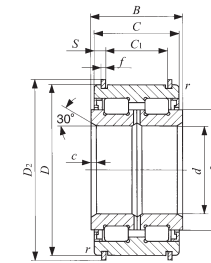

NAS50...ZZNR

<i>f</i>	<i>c</i>	<i>r</i> _{s min} ⁽¹⁾	<i>J</i>	Basic dynamic load rating <i>C</i> N	Basic static load rating <i>C</i> ₀ N	Allowable rotational speed ⁽²⁾ rpm
2	1.5	0.6	50	79 500	116 000	2 500
2	1.5	0.6	56	95 500	144 000	2 000
2	1.5	0.6	61	100 000	158 000	2 000
2.5	2	0.6	68	118 000	193 000	1 800
2.5	2	0.6	73	123 000	208 000	1 700
2.5	2	0.6	78	128 000	224 000	1 600
2.5	2	0.6	84	171 000	284 000	1 400
2.5	2	0.6	91	179 000	308 000	1 300
2.5	2	0.6	97	251 000	428 000	1 300
2.5	2	0.6	101	257 000	446 000	1 200
2.5	2.5	0.6	110	305 000	540 000	1 100
2.5	2.5	0.6	114	312 000	562 000	1 100
2.5	2.5	0.6	118	318 000	584 000	1 000
2.5	3	1	130	384 000	697 000	900
3	3	1	139.5	400 000	750 000	850
3	3	1	156	537 000	1 000 000	750
3	3	1	167	543 000	1 070 000	700
3	3.5	1	176.5	623 000	1 210 000	650
3	3.5	1.5	188.5	720 000	1 390 000	650
4	3.5	1.5	204.5	857 000	1 730 000	600

1N=0.102kgf=0.2248lbs.
 1mm=0.03937inch

ROLLER BEARINGS

Roller Bearings for Sheaves



Shaft dia. 180 – 440mm

Shaft dia. mm	Identification number		Mass (Ref.) kg	Boundary dimensions mm							
	Sealed type	Shield type		<i>d</i>	<i>D</i>	<i>D</i> ₂	<i>B</i>	<i>C</i>	<i>C</i> ₁	<i>S</i>	
180	NAS 5036UUNR	NAS 5036ZZNR	30.0	180	280	294	136	135	110	12.5	
190	NAS 5038UUNR	NAS 5038ZZNR	31.5	190	290	306	136	135	110	12.5	
200	NAS 5040UUNR	NAS 5040ZZNR	40.5	200	310	326	150	149	120	14.5	
220	NAS 5044UUNR	NAS 5044ZZNR	52.0	220	340	356	160	159	130	14.5	
240	NAS 5048UUNR	NAS 5048ZZNR	55.5	240	360	376	160	159	130	14.5	
260	NAS 5052UUNR	NAS 5052ZZNR	85.0	260	400	416	190	189	154	17.5	
280	NAS 5056UUNR	NAS 5056ZZNR	90.9	280	420	440	190	189	154	17.5	
300	NAS 5060UU	NAS 5060ZZ	130	300	460	—	218	216	—	—	
320	NAS 5064UU	NAS 5064ZZ	135	320	480	—	218	216	—	—	
340	NAS 5068UU	NAS 5068ZZ	180	340	520	—	243	241	—	—	
360	NAS 5072UU	NAS 5072ZZ	190	360	540	—	243	241	—	—	
380	NAS 5076UU	NAS 5076ZZ	200	380	560	—	243	241	—	—	
400	NAS 5080UU	NAS 5080ZZ	265	400	600	—	272	270	—	—	
420	NAS 5084UU	NAS 5084ZZ	275	420	620	—	272	270	—	—	
440	NAS 5088UU	NAS 5088ZZ	310	440	650	—	280	278	—	—	

- Notes⁽¹⁾ Minimum allowable value of chamfer dimension *r*
⁽²⁾ Allowable rotational speed applies to grease lubrication. Considering that the axial load acts under practical operating conditions, up to 1/10 of this value is recommended for actual use.
- Remarks 1. The bearings with a bore diameter *d* of 300 mm or more has neither stop rings nor stop ring grooves.
 2. The inner ring has an oil groove and two oil holes.
 3. Roller Bearings for Sheaves are provided with prepacked grease.

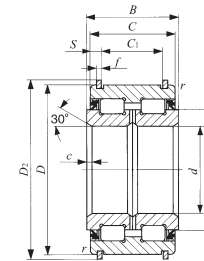

NAS50...UUNR

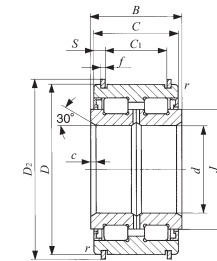

NAS50...ZZNR

<i>f</i>	<i>c</i>	<i>r</i> _{s min} ⁽¹⁾	<i>J</i>	Basic dynamic load rating	Basic static load rating	Allowable rotational speed ⁽²⁾
				<i>C</i> N	<i>C</i> ₀ N	rpm
5	3.5	1.5	217	1 070 000	2 140 000	550
5	3.5	1.5	225	1 120 000	2 230 000	500
5	3.5	1.5	242	1 310 000	2 650 000	500
6	4	1.5	260	1 510 000	3 110 000	450
6	4	1.5	278.5	1 570 000	3 350 000	400
7	5	2	312	2 130 000	4 510 000	350
7	5	2	335	2 210 000	4 860 000	350
—	5	2	359	2 670 000	5 870 000	300
—	5	2	375	2 700 000	6 140 000	300
—	6	2.5	404	3 370 000	7 560 000	300
—	6	2.5	423	3 420 000	7 940 000	250
—	6	2.5	442	3 580 000	8 300 000	250
—	6	2.5	471	4 250 000	10 100 000	250
—	6	2.5	490	4 390 000	10 400 000	250
—	8	3	516	4 570 000	10 900 000	200

1N=0.102kgf=0.2248lbs.
 1mm=0.03937inch

E
 NAG
 NAU
 TRU
 NAS

THRUST BEARINGS

- Thrust Needle Roller Bearings
- Thrust Roller Bearings



Structures of Thrust Bearings

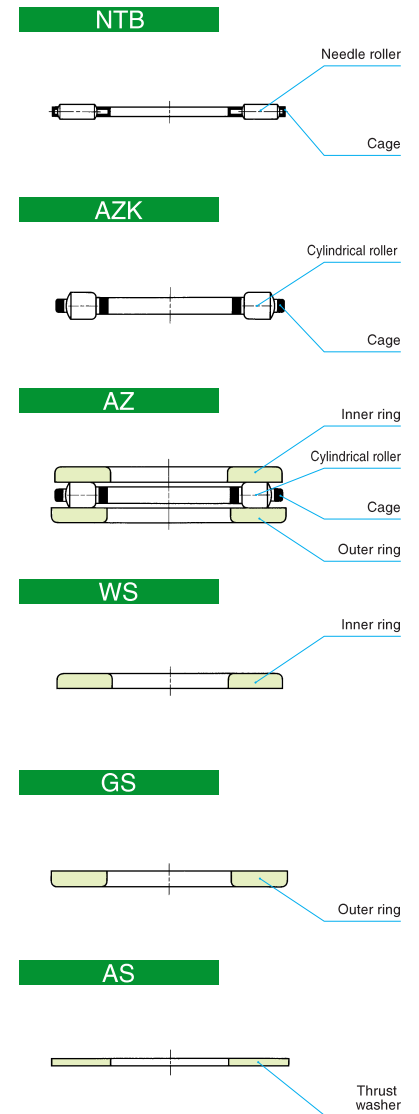

F

NTB
AS
AZK
WS-GS

Types

Table 1.1 Type of bearing

Type	Thrust needle roller bearings	Thrust roller bearings	
		Without inner and outer rings	With inner and outer rings
Model code	NTB	AZK	AZ

Table 1.2 Type of bearing ring

Type	Inner ring	Outer ring	Thrust washer
Model code	WS	GS	AS

Thrust Needle Roller Bearings

These bearings consist of a cage made from a steel plate, which is precisely press formed and surface-hardened, and needle rollers with a diameter variation within $2\mu\text{m}$. They have a rigid structure and a high lubricant-retaining capacity.

As they have the lowest sectional height compared with other thrust bearings, they can be used instead of conventional thrust washers and can withstand high-speed rotations with a low coefficient of friction. Specially designed thin inner rings (WS) and outer rings (GS), and especially thin (1 mm thick) thrust washers (AS), are available for use in various applications.

These bearings are generally used by utilizing their inner surface as the guide surface.

Thrust Roller Bearings

In this series, the caged cylindrical rollers AZK and the complete bearings AZ in which AZK are combined with an inner ring (WS) and an outer ring (GS) are available.

The cage has a special precise structure which is highly rigid, and cylindrical rollers are outwardly arranged and guided by the cage with exact precision to enable them to withstand heavy loads even at high rotational speeds.

Owing to the high accuracy of the bearing height T , they are suitable for use in machine tools, ultra-high pressure pumps, etc.

These bearings are generally used by utilizing their inner surface as the guide surface.

Identification Number

The identification number of Thrust Bearings consists of a model code, dimensions and a classification symbol. Some examples are shown below.

Examples of identification number

Example 1 (In case of NTB or AS)

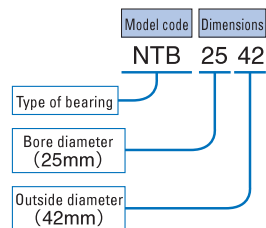

Example 2 (In case of AZ or AZK)

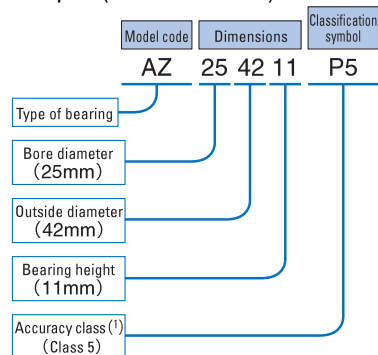

Example 3 (In case of WS or GS)

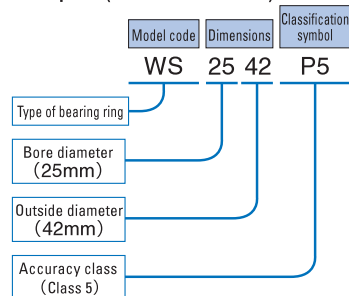

Note⁽¹⁾ Not applicable to the model AZK.

Accuracy

The accuracy of Thrust Bearings is based on JIS B 1514:2000 as shown in Table 2.

Table 2.1 Tolerances

unit: μm

Type of bearing	Item	Dimension	Dimension symbol	Tolerance	
Thrust needle roller bearings	NTB	Bore diameter	d	E11	
		Outside diameter	D	c12	
		Width	D_w	Equivalent to JIS B 1506 Class 2	
Thrust roller bearings	AZK	Bore diameter	d_c	As per Table 2.2	
		Outside diameter	D_c		
	AZ	Width	D_w	$1 \leq D_w \leq 10$	Equivalent to JIS B 1506 Class 2
				$10 < D_w \leq 30$	Equivalent to JIS B 1506 Class 3
Inner rings	WS	Height	T	As per Table 2.3	
		Bore diameter	d	As per Table 2.4	
		Outside diameter	D	b12	
Outer rings	GS	Width	B	h11	
		Bore diameter	d	B12	
		Outside diameter	D	As per Table 2.4	
Thrust washers	AS	Width	B	h11	
		Bore diameter	d	E12	
		Outside diameter	D	e12	
		Width	s	± 50	

Table 2.2 Tolerances of bore and outside diameters for AZK series

unit: μm

Nominal dimension mm		Δ_{d_c} Cage bore diameter deviation		Δ_{D_c} Cage outside diameter deviation	
Over	Incl.	High	Low	High	Low
—	50	+100	0	0	—300
50	100	+200	0	0	—400
100	200	+300	0	0	—500
200	300	+500	0	0	—700
300	400	+700	0	0	—1000
400	500	—	—	0	—1200

Table 2.3 Tolerances of height for AZ series

unit: μm

d Nominal bearing bore dia. mm		Δ_{T_s} Deviation of an actual bearing height	
Over	Incl.	High	Low
—	18	0	—75
18	30	0	—75
30	50	0	—100
50	80	0	—125
80	120	0	—150
120	180	0	—175
180	250	0	—200
250	315	0	—225
315	400	0	—300
400	500	0	—400

1N=0.102kgf=0.2248lbs.
1mm=0.03937inch

Table 2.4 Tolerances and allowable values for WS and GS

unit: μm

d or D ⁽¹⁾ Nominal bearing bore dia. or outside dia. mm		Inner ring			Outer ring			Inner ring or outer ring		
		Δ_{dmp} Single plane mean bore diameter deviation		V_{dsp} Bore diameter variation in a single radial plane	Δ_{Dmp} Single plane mean outside diameter deviation		V_{Dsp} Outside diameter variation in a single radial plane	S_1 or S_2 ⁽²⁾ Bearing ring thickness variation		
Over	Incl.	High	Low	Max.	High	Low	Max.	Class 0	Class 6	Class 5
—	18	0	- 8	6	0	- 11	8	10	5	3
18	30	0	- 10	8	0	- 13	10	10	5	3
30	50	0	- 12	9	0	- 16	12	10	6	3
50	80	0	- 15	11	0	- 19	14	10	7	4
80	120	0	- 20	15	0	- 22	17	15	8	4
120	180	0	- 25	19	0	- 25	19	15	9	5
180	250	0	- 30	23	0	- 30	23	20	10	5
250	315	0	- 35	26	0	- 35	26	25	13	7
315	400	0	- 40	30	0	- 40	30	30	15	7
400	500	0	- 45	34	0	- 45	34	30	18	9

Notes ⁽¹⁾ d for Δ_{dmp} and V_{dsp} , and D for Δ_{Dmp} and V_{Dsp} , respectively.

d for thickness variations of inner and outer rings .

⁽²⁾ d_i for thickness variations of rings for NAX(I) and NBX(I) .

Table 2.5 Permissible limit values for chamfer dimension

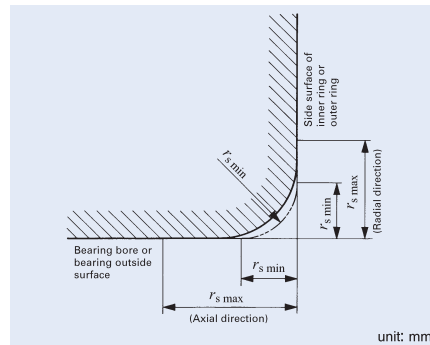

unit: mm

$r_{s \text{ min}}$	Radial and axial directions	
	$r_{s \text{ max}}$	
0.3	0.8	
0.6	1.5	
1	2.2	
1.1	2.7	
1.5	3.5	
2	4	
2.1	4.5	
3	5.5	
4	6.5	
5	8	

Fit

The recommended fits for Thrust Bearings are shown in Table 3.

Table 3 Recommended fits

Type of bearing		Tolerance class	
		Shaft	Housing bore
Thrust needle roller bearings	NTB	h8(h10)	—
Thrust roller bearings	AZK	h6(h8)	—
	AZ		H7(H9)
Inner rings	WS	h6(h8)	—
Outer rings	GS	—	H7(H9)
Thrust washers	AS	h8(h10)	—

Mounting

When mounting Thrust Bearings, the following items should be considered.

① When inner and outer rings are not used, the hardness of the raceway surfaces should be 58~64HRC, the effective hardening depth should be adequate, and the surface roughness should be less than $0.2 \mu\text{m} R_a$.

② When mounting inner and outer rings to shaft and housing bore, dimensions related to mounting should be based on the dimension tables.

Also, the mounting surfaces should be finished at right angles to the center axis and they should be sufficiently rigid.

③ To avoid elastic deformation, the thrust washer AS must be seated uniformly on its mating surface.

A small warp in an AS washer will be corrected automatically when an axial load is applied.

④ Thrust Roller Bearings are combinations of a copper alloy component and cylindrical rollers. When handling the AZK itself, care should be taken to prevent deformations, blemishes, etc.

F

NTB
AS
AZK
WS-GS

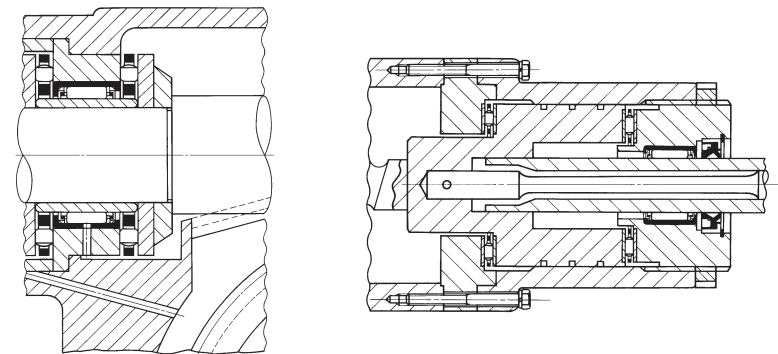
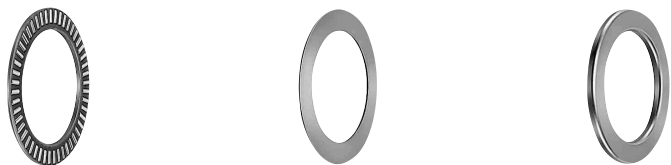

Fig.1 Mounting examples

1N=0.102kgf=0.2248lbs.
1mm=0.03937inch

THRUST BEARINGS

Thrust Needle Roller Bearings



Shaft dia. 10 – 85mm

Shaft dia. mm	Identification number						
	Thrust needle roller bearing	Mass (Ref.) g	Thrust washer	Mass (Ref.) g	Inner ring	Outer ring	Mass (Ref.) g
10	NTB 1024	3.3	AS 1024	2.9	WS 1024	GS 1024	8
12	NTB 1226	3.8	AS 1226	3.2	WS 1226	GS 1226	8.9
15	NTB 1528	4.1	AS 1528	3.4	WS 1528	GS 1528	9.3
16	NTB 1629	4.3	AS 1629	3.6	WS 1629	GS 1629	9.8
17	NTB 1730	4.5	AS 1730	3.7	WS 1730	GS 1730	10.2
18	NTB 1831	4.7	AS 1831	3.9	WS 1831	GS 1831	10.7
20	NTB 2035	6.1	AS 2035	5	WS 2035	GS 2035	13.8
25	NTB 2542	8.2	AS 2542	6.9	WS 2542	GS 2542	21
30	NTB 3047	9.4	AS 3047	7.9	WS 3047	GS 3047	24
35	NTB 3552	10.6	AS 3552	8.9	WS 3552	GS 3552	31.5
40	NTB 40603	22	AS 4060	12.1	WS 4060	GS 4060	42.5
45	NTB 4565	24.5	AS 4565	13.3	WS 4565	GS 4565	53.5
50	NTB 5070	26.5	AS 5070	14.5	WS 5070	GS 5070	58.5
55	NTB 5578	33.5	AS 5578	18.5	WS 5578	GS 5578	93
60	NTB 6085	38.5	AS 6085	22	WS 6085	GS 6085	105
65	NTB 6590	41.5	AS 6590	23.5	WS 6590	GS 6590	124
70	NTB 7095	61	AS 7095	25	WS 7095	GS 7095	132
75	NTB 75100	65	AS 75100	26.5	WS 75100	GS 75100	153
80	NTB 80105	68.5	AS 80105	28	WS 80105	GS 80105	162
85	NTB 85110	72	AS 85110	29.5	WS 85110	GS 85110	170

Notes⁽¹⁾ Minimum allowable value of chamfer dimension r

⁽²⁾ Allowable rotational speed applies to oil lubrication. For grease lubrication, a maximum of 25% of this value is allowable.

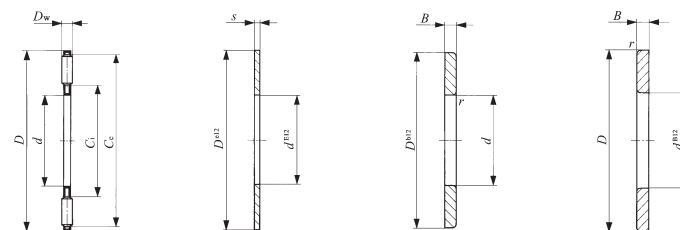

NTN

AS

WS

GS

d	Boundary dimensions mm								Basic dynamic load rating C N	Basic static load rating C_0 N	Allowable rotational speed ⁽²⁾ rpm
	D	D_w	s	B	$r_{s \min}$ ⁽¹⁾	C_1	C_e				
10	24	2	1	2.75	0.3	14	22	7 820	23 900	15 000	
12	26	2	1	2.75	0.3	16	24	8 340	26 900	13 000	
15	28	2	1	2.75	0.3	18	26	8 830	29 900	12 000	
16	29	2	1	2.75	0.3	19	27	9 070	31 400	11 000	
17	30	2	1	2.75	0.3	20	28	9 320	32 900	11 000	
18	31	2	1	2.75	0.3	21	29	9 550	34 400	10 000	
20	35	2	1	2.75	0.3	23	33	11 700	46 500	9 000	
25	42	2	1	3	0.6	29	40	14 400	64 700	7 500	
30	47	2	1	3	0.6	34	45	15 400	73 300	6 500	
35	52	2	1	3.5	0.6	39	50	16 300	81 900	5 500	
40	60	3	1	3.5	0.6	45	57	24 200	108 000	5 000	
45	65	3	1	4	0.6	50	62	25 900	121 000	4 500	
50	70	3	1	4	0.6	55	67	27 600	135 000	4 000	
55	78	3	1	5	0.6	61	75	32 400	171 000	4 000	
60	85	3	1	4.75	1	66	82	38 200	219 000	3 500	
65	90	3	1	5.25	1	71	87	40 100	237 000	3 000	
70	95	4	1	5.25	1	75	91	47 400	244 000	3 000	
75	100	4	1	5.75	1	80	96	48 400	256 000	3 000	
80	105	4	1	5.75	1	85	101	49 500	267 000	2 500	
85	110	4	1	5.75	1	90	106	50 300	279 000	2 500	

1N=0.102kgf=0.2248lbs.
1mm=0.03937inch

F
NTN
AS
AZK
WS-GS

THRUST BEARINGS

Thrust Needle Roller Bearings

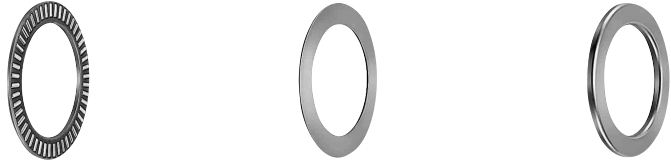

Shaft dia. 90 – 130mm

Shaft dia. mm	Identification number						
	Thrust needle roller bearing	Mass (Ref.) g	Thrust washer	Mass (Ref.) g	Inner ring	Outer ring	Mass (Ref.) g
90	NTB 90120	92	AS 90120	38	WS 90120	GS 90120	250
100	NTB 100135	119	AS 100135	50	WS 100135	GS 100135	350
110	NTB 110145	129	—	—	WS 110145	GS 110145	380
120	NTB 120155	139	—	—	WS 120155	GS 120155	410
130	NTB 130170	225	—	—	WS 130170	GS 130170	660

Notes⁽¹⁾ Minimum allowable value of chamfer dimension r

⁽²⁾ Allowable rotational speed applies to oil lubrication. For grease lubrication, a maximum of 25% of this value is allowable.

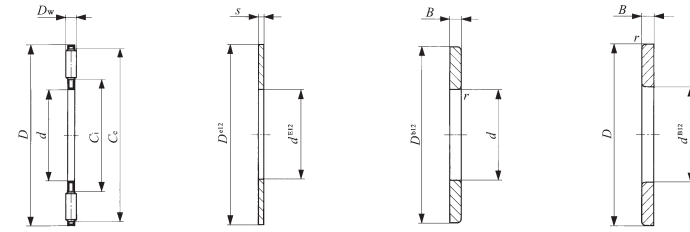

NTB

AS

WS

GS

d	Boundary dimensions mm								Basic dynamic load rating C N	Basic static load rating C_0 N	Allowable rotational speed ⁽²⁾ rpm
	D	D_w	s	B	$r_{s \min}$ ⁽¹⁾	C_i	C_e				
90	120	4	1	6.5	1	96	116	64 500	394 000	2 500	
100	135	4	1	7	1	107	131	80 300	541 000	2 000	
110	145	4	—	7	1	117	141	83 200	578 000	2 000	
120	155	4	—	7	1	127	151	87 900	634 000	1 800	
130	170	5	—	9	1	137	165	120 000	839 000	1 700	

1N=0.102kgf=0.2248lbs.

1mm=0.03937inch

F

NTB
AS
AZK
WS-GS

THRUST BEARINGS

Thrust Roller Bearings



Shaft dia. 10 – 65mm

Shaft dia. mm	Identification number						
	Thrust roller bearing	Mass (Ref.) g	Thrust roller bearing	Mass (Ref.) g	Inner ring	Outer ring	Mass (Ref.) g
10	AZ 10249	24.6	AZK 10243.5	8.6	WS 1024	GS 1024	
12	AZ 12269	27.5	AZK 12263.5	8.7	WS 1226	GS 1226	9.9
15	AZ 15289	29.2	AZK 15283.5	9.4	WS 1528	GS 1528	9.3
17	AZ 17309	30.5	AZK 17303.5	10.1	WS 1730	GS 1730	10.2
20	AZ 203510	45.5	AZK 20354.5	17.9	WS 2035	GS 2035	13.8
25	AZ 254211	70	AZK 25425	28	WS 2542	GS 2542	21
30	AZ 304711	79	AZK 30475	31	WS 3047	GS 3047	24
	AZ 305216	160	AZK 30527.5	70	WS 3052	GS 3052	45
35	AZ 355212	99	AZK 35525	36	WS 3552	GS 3552	31.5
	AZ 356218	260	AZK 35627.5	98	WS 3562	GS 3562	81
40	AZ 406013	139	AZK 40606	54	WS 4060	GS 4060	42.5
	AZ 406819	310	AZK 40689	132	WS 4068	GS 4068	89
45	AZ 456514	169	AZK 45656	62	WS 4565	GS 4565	53.5
	AZ 457320	360	AZK 45739	144	WS 4573	GS 4573	108
50	AZ 507014	185	AZK 50706	68	WS 5070	GS 5070	58.5
	AZ 507822	430	AZK 507811	194	WS 5078	GS 5078	118
55	AZ 557816	275	AZK 55786	89	WS 5578	GS 5578	93
	AZ 559025	725	AZK 559011	275	WS 5590	GS 5590	225
60	AZ 608517	345	AZK 60857.5	135	WS 6085	GS 6085	105
	AZ 609526	770	AZK 609511	290	WS 6095	GS 6095	240
	AZ 6013026	2 090	AZK 6013010	790	WS 60130	GS 60130	650
65	AZ 659018	380	AZK 65907.5	132	WS 6590	GS 6590	124
	AZ 6510027	860	AZK 6510011	310	WS 65100	GS 65100	275

Notes⁽¹⁾ Minimum allowable value of chamfer dimension *r*
⁽²⁾ Allowable rotational speed applies to oil lubrication. For grease lubrication, a maximum of 25% of this value is allowable.

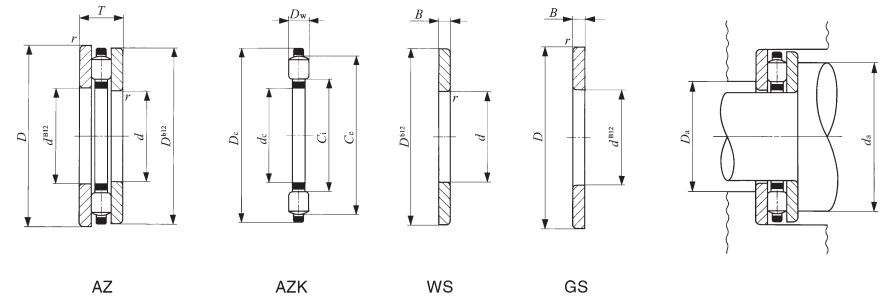

Shaft dia. mm	Boundary dimensions mm										Standard mounting dimensions mm		Basic dynamic load rating C N	Basic static load rating C ₀ N	Allowable rotational speed ⁽²⁾ rpm
	T	c	c	w	B	⁽¹⁾ min	C _i	C _e	d _a Min.	D _a Max.					
10	24	9	10.04	23.6	3.5	2.75	0.3	13	21	21	13	990	19 100	18 000	
12	26	9	12.04	25.6	3.5	2.75	0.3	15	23	23	16	10 400	23 900	16 000	
15	28	9	15.04	27.6	3.5	2.75	0.3	17	25	25	18	10 200	23 900	14 000	
17	30	9	17.04	29.6	3.5	2.75	0.3	19	27	27	20	11 400	28 600	13 000	
20	35	10	20.04	34.6	4.5	2.75	0.3	22	33	33	23	19 000	48 700	11 000	
25	42	11	25.05	41.6	5	3	0.6	28	39	39	28	22 700	60 700	9 000	
30	47	11	30.05	46.5	5	3	0.6	33	44	44	33	27 400	81 000	8 000	
	52	16	30.05	51.5	7.5	4.25	0.6	35	49	48	36	38 400	95 700	7 500	
35	52	12	35.05	51.5	5	3.5	0.6	38	49	49	39	29 100	91 100	7 000	
	62	18	35.05	61.5	7.5	5.25	1	42	58	57	43	47 900	135 000	6 500	
40	60	13	40.05	59.5	6	3.5	0.6	44	57	57	44	41 700	133 000	6 000	
	68	19	40.05	67.5	9	5	1	45	64	64	46	68 700	195 000	5 500	
45	65	14	45.05	64.5	6	4	0.6	49	62	62	49	40 800	133 000	5 500	
	73	20	45.05	72.5	9	5.5	1	50	69	69	51	75 700	227 000	5 000	
50	70	14	50.05	69.5	6	4	0.6	54	67	67	54	43 300	148 000	5 000	
	78	22	50.05	77.5	11	5.5	1	55	74	73	56	84 300	232 000	4 500	
55	78	16	55.05	77.5	6	5	0.6	59	75	75	60	51 700	192 000	4 500	
	90	25	55.05	89.5	11	7	1	63	85	84	63	108 000	332 000	4 000	
60	85	17	60.05	84.5	7.5	4.75	1	65	81	81	66	64 600	224 000	4 000	
	95	26	60.05	94.5	11	7.5	1	68	90	89	68	106 000	332 000	4 000	
	130	26	60.05	129.5	10	8	1.5	79	119	119	80	158 000	634 000	3 000	
65	90	18	65.05	89.5	7.5	5.25	1	70	86	86	71	68 300	247 000	4 000	
	100	27	65.05	99.5	11	8	1	73	95	94	73	116 000	379 000	3 500	

1N=0.102kgf=0.2248lbs.
 1mm=0.03937inch

F

NTB
AS
AZK
WS-GS

THRUST BEARINGS

Thrust Roller Bearings



Shaft dia. 70 – 130mm

Shaft dia. mm	Identification number						
	Thrust roller bearing	Mass (Ref.) g	Thrust roller bearing	Mass (Ref.) g	Inner ring	Outer ring	Mass (Ref.) g
70	AZ 709518	420	AZK 70957.5	156	WS 7095	GS 7095	132
	AZ 7010527	905	AZK 7010511	325	WS 70105	GS 70105	290
	AZ 7014026	2 250	AZK 7014010	890	WS 70140	GS 70140	680
75	AZ 7510019	465	AZK 751007.5	159	WS 75100	GS 75100	153
	AZ 7511027	960	AZK 7511011	340	WS 75110	GS 75110	310
80	AZ 8010519	495	AZK 801057.5	171	WS 80105	GS 80105	162
	AZ 8011528	1 060	AZK 8011511	370	WS 80115	GS 80115	345
	AZ 8015026	2 500	AZK 8015010	920	WS 80150	GS 80150	790
85	AZ 8511019	530	AZK 851107.5	190	WS 85110	GS 85110	170
	AZ 8512531	1 460	AZK 8512512	510	WS 85125	GS 85125	475
90	AZ 9012022	790	AZK 901209	290	WS 90120	GS 90120	250
	AZ 9013535	2 040	AZK 9013514	750	WS 90135	GS 90135	645
	AZ 9016026	2 710	AZK 9016010	1 000	WS 90160	GS 90160	855
100	AZ 10013525	1 190	AZK 10013511	490	WS 100135	GS 100135	350
	AZ 10015038	2 720	AZK 10015015	980	WS 100150	GS 100150	870
	AZ 10019039	5 960	AZK 10019015	2 120	WS 100190	GS 100190	1 920
110	AZ 11014525	1 350	AZK 11014511	590	WS 110145	GS 110145	380
	AZ 11016040	3 220	AZK 11016017	1 320	WS 110160	GS 110160	950
	AZ 11020039	6 400	AZK 11020015	2 280	WS 110200	GS 110200	2 060
120	AZ 12015525	1 450	AZK 12015511	630	WS 120155	GS 120155	410
	AZ 12017542	4 020	AZK 12017518	1 640	WS 120175	GS 120175	1 190
	AZ 12022039	7 730	AZK 12022015	2 730	WS 120220	GS 120220	2 500
130	AZ 13017030	2 180	AZK 13017012	860	WS 130170	GS 130170	660
	AZ 13018542	4 300	AZK 13018518	1 760	WS 130185	GS 130185	1 270
	AZ 13023039	8 240	AZK 13023015	2 940	WS 130230	GS 130230	2 650

Notes⁽¹⁾ Minimum allowable value of chamfer dimension r
⁽²⁾ Allowable rotational speed applies to oil lubrication. For grease lubrication, a maximum of 25% of this value is allowable.

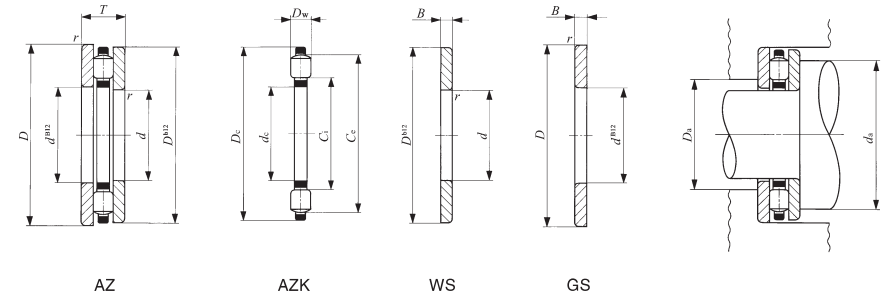

Boundary dimensions mm											Standard mounting dimensions mm		Basic dynamic load rating	Basic static load rating	Allowable rotational speed ⁽²⁾
d	D	T	d_c	D_c	D_w	B	$r_{s \min}^{(1)}$	C_i	C_e	d_a Min.	D_a Max.	C N	C_0 N	rpm	
70	95	18	70.05	94.5	7.5	5.25	1	75	91	91	76	72 000	269 000	3 500	
70	105	27	70.05	104.5	11	8	1	78 100	99	78	114 000	379 000	3 500		
70	140	26	70.05	139.5	10	8	1.1	89 129	129	90	169 000	713 000	3 000		
75	100	19	75.05	99.5	7.5	5.75	1	80	96	96	81	71 100	269 000	3 500	
75	110	27	75.05	109.5	11	8	1	83 105	104	83	123 000	427 000	3 000		
80	105	19	80.05	104.5	7.5	5.75	1	85 101	101	86	74 500	292 000	3 000		
80	115	28	80.05	114.5	11	8.5	1	88 110	109	88	122 000	427 000	3 000		
80	150	26	80.05	149.5	10	8	1.5	99 139	139	100	180 000	792 000	2 500		
85	110	19	85.05	109.5	7.5	5.75	1	90 106	106	91	77 800	314 000	3 000		
85	125	31	85.05	124.5	12	9.5	1	95 119	118	95	145 000	513 000	3 000		
90	120	22	90.05	119.5	9	6.5	1	97 116	115	97	99 700	390 000	3 000		
90	135	35	90.05	134.5	14	10.5	1.1	100 129	128	101	181 000	626 000	2 500		
90	160	26	90.05	159.5	10	8	1.5	109 149	149	110	189 000	871 000	2 500		
100	135	25	100.05	134.5	11	7	1	108 130	129	108	136 000	522 000	2 500		
100	150	38	100.05	149.5	15	11.5	1.1	112 143	142	113	219 000	796 000	2 500		
100	190	39	100.1	189.3	15	12	1.5	119 179	177	120	333 000	1 420 000	2 000		
110	145	25	110.1	144.5	11	7	1	118 140	139	118	142 000	569 000	2 500		
110	160	40	110.1	159.5	17	11.5	1.1	120 154	153	121	282 000	1 030 000	2 000		
110	200	39	110.1	199.3	15	12	2	129 188	187	130	388 000	1 770 000	2 000		
120	155	25	120.1	154.5	11	7	1	128 150	149	128	149 000	617 000	2 000		
120	175	42	120.1	174.5	18	12	1.1	132 168	167	133	313 000	1 160 000	2 000		
120	220	39	120.1	219	15	12	2.1	141 207	206	142	415 000	1 980 000	1 800		
130	170	30	130.1	169.5	12	9	1	140 164	163	140	176 000	741 000	2 000		
130	185	42	130.1	184.5	18	12	1.5	142 178	177	143	333 000	1 290 000	1 900		
130	230	39	130.1	229	15	12	2.1	151 217	216	152	440 000	2 180 000	1 700		

1N=0.102kgf=0.2248lbs.
 1mm=0.03937inch



THRUST BEARINGS

Thrust Roller Bearings



Shaft dia. 140 – 280mm

Shaft dia. mm	Identification number						
	Thrust roller bearing	Mass (Ref.) g	Thrust roller bearing	Mass (Ref.) g	Inner ring	Outer ring	Mass (Ref.) g
140	AZ 14018031	2 410	AZK 14018012	920	WS 140180	GS 140180	745
	AZ 14019542	4 560	AZK 14019518	1 860	WS 140195	GS 140195	1 350
	AZ 14024039	8 680	AZK 14024015	3 100	WS 140240	GS 140240	2 790
150	AZ 15019031	2 560	AZK 15019012	980	WS 150190	GS 150190	790
	AZ 15020542	4 840	AZK 15020518	1 980	WS 150205	GS 150205	1 430
	AZ 15025039	9 140	AZK 15025015	3 260	WS 150250	GS 150250	2 940
160	AZ 16020031	2 710	AZK 16020012	1 030	WS 160200	GS 160200	840
	AZ 16027039	10 800	AZK 16027015	3 840	WS 160270	GS 160270	3 480
170	AZ 17023045	6 220	AZK 17023019	2 420	WS 170230	GS 170230	1 900
	AZ 17028039	11 300	AZK 17028015	4 020	WS 170280	GS 170280	3 640
180	AZ 18024045	6 540	AZK 18024019	2 540	WS 180240	GS 180240	2 000
	AZ 18031039	14 600	AZK 18031015	5 200	WS 180310	GS 180310	4 700
190	AZ 19025548	8 060	AZK 19025520	3 100	WS 190255	GS 190255	2 480
	AZ 19032039	15 000	AZK 19032015	5 280	WS 190320	GS 190320	4 860
200	AZ 20026548	8 430	AZK 20026520	3 250	WS 200265	GS 200265	2 590
	AZ 20034039	17 200	AZK 20034015	6 120	WS 200340	GS 200340	5 540
220	AZ 22029050	10 400	AZK 22029022	4 280	WS 220290	GS 220290	3 060
	AZ 22036052	24 000	AZK 22036020	8 000	WS 220360	GS 220360	8 000
240	AZ 24031554	13 200	AZK 24031524	5 520	WS 240315	GS 240315	3 840
	AZ 24038052	26 500	AZK 24038020	9 440	WS 240380	GS 240380	8 530
260	AZ 26034055	15 400	AZK 26034025	6 600	WS 260340	GS 260340	4 400
	AZ 26042080	51 600	AZK 26042030	18 200	WS 260420	GS 260420	16 700
280	AZ 28044080	54 600	AZK 28044030	19 200	WS 280440	GS 280440	17 700

Notes⁽¹⁾ Minimum allowable value of chamfer dimension r
⁽²⁾ Allowable rotational speed applies to oil lubrication. For grease lubrication, a maximum of 25% of this value is allowable.

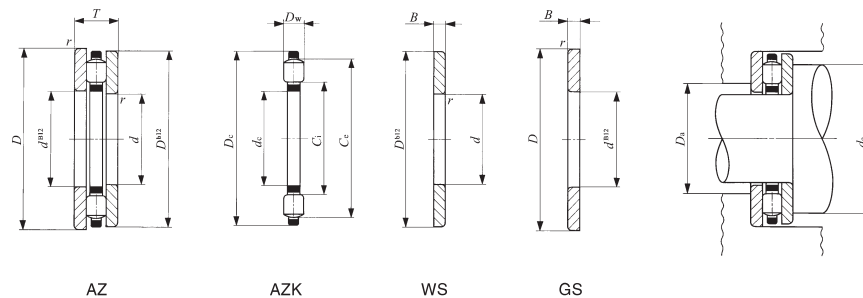

Boundary dimensions mm											Standard mounting dimensions mm		Basic dynamic load rating	Basic static load rating	Allowable rotational speed ⁽²⁾
d	D	T	d_c	D_c	D_w	B	$r_{s \min}^{(1)}$	C_i	C_e	d_a Min.	d_a Max.	C	C_0	rpm	
140	180	31	140.1	179.5	12	9.5	1	150	174	173	150	184 000	798 000	1 900	
140	195	42	140.1	194.5	18	12	1.5	152	188	187	153	353 000	1 420 000	1 800	
140	240	39	140.1	239	15	12	2.1	161	227	226	162	435 000	2 180 000	1 600	
150	190	31	150.1	189.5	12	9.5	1	160	184	183	160	181 000	798 000	1 800	
150	205	42	150.1	204.5	18	12	1.5	162	198	197	163	349 000	1 420 000	1 700	
150	250	39	150.1	249	15	12	2.1	171	237	236	172	459 000	2 380 000	1 500	
160	200	31	160.1	199.5	12	9.5	1	170	194	193	170	189 000	855 000	1 700	
160	270	39	160.1	269	15	12	3	183	256	255	184	519 000	2 850 000	1 400	
170	230	45	170.1	229	19	13	1.5	183	221	220	184	406 000	1 730 000	1 500	
170	280	39	170.1	279	15	12	3	193	266	265	194	543 000	3 070 000	1 300	
180	240	45	180.1	239	19	13	1.5	193	231	230	194	426 000	1 870 000	1 400	
180	310	39	180.1	308	15	12	3	204	294	293	205	619 000	3 710 000	1 200	
190	255	48	190.1	254	20	14	2	205	245	244	206	470 000	2 080 000	1 300	
190	320	39	190.1	318	15	12	4	214	304	303	215	647 000	3 980 000	1 200	
200	265	48	200.15	264	20	14	2	215	255	254	216	465 000	2 080 000	1 300	
200	340	39	200.15	338	15	12	4	227	323	322	228	710 000	4 580 000	1 100	
220	290	50	220.15	289	22	14	2	236	280	278	237	557 000	2 530 000	1 300	
220	360	52	220.15	358	20	16	4	246	343	342	247	943 000	5 520 000	1 000	
240	315	54	240.15	314	24	15	2	256	304	302	257	695 000	3 250 000	1 100	
240	380	52	240.15	378	20	16	4	266	363	362	267	977 000	5 910 000	1 000	
260	340	55	260.15	339	25	15	2.1	278	328	326	279	739 000	3 510 000	1 000	
260	420	80	260.15	418	30	25	5	289	402	400	291	1 430 000	7 490 000	900	
280	440	80	280.15	438	30	25	5	309	422	420	311	1 420 000	7 490 000	800	

1N=0.102kgf=0.2248lbs.
 1mm=0.03937inch

COMBINED TYPE NEEDLE ROLLER BEARINGS

- Needle Roller Bearings with Thrust Ball Bearing
- Needle Roller Bearings with Thrust Roller Bearing
- Needle Roller Bearings with Angular Contact Ball Bearing
- Needle Roller Bearings with Three-point Contact Ball Bearing



Structures of Combined Type Needle Roller Bearings

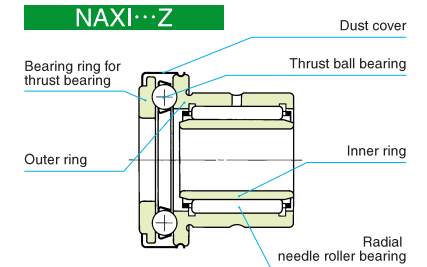

NBXI

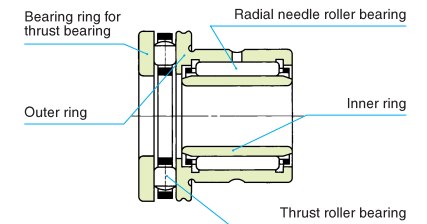

NATA

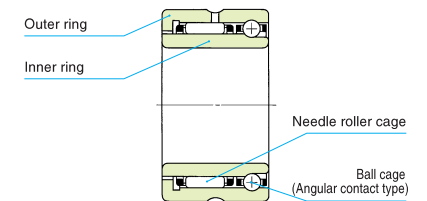

NATB

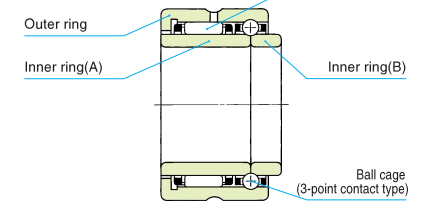

Types

Table 1.1 Type of bearing

Type	Combined with thrust ball bearing		Combined with thrust roller bearing	
	Without inner ring	With inner ring	Without inner ring	With inner ring
—	NAX	NAXI	NBX	NBXI
With dust cover	NAX...Z	NAXI...Z	NBX...Z	NBXI...Z

Table 1.2 Type of bearing

Type	Combined with angular contact ball bearing	Combined with three-point contact ball bearing
Model code	NATA	NATB

Needle Roller Bearings with Thrust Ball Bearing

In this series, needle roller bearings are combined with thrust ball bearings to receive thrust loads.

In bearings with a dust cover, the dust cover is formed from a thin steel plate and fixed to a groove cut on the outer cylindrical surface of the outer ring collar. The cover forms a labyrinth with the thrust raceway ring, and is therefore effective in preventing leakage of grease and penetration of dust and dirt.

In the case of bearings without an inner ring, the tolerances of roller set bore diameter F_w are shown in Table 14 on page A33. Therefore, the required radial internal clearances can be selected by combining the bearings with shafts that have been heat-treated and finished by grinding as shown in Table 23 on page A42 and Table 26 on page A44.

G

NAX
NBX
NATA
NATB

Needle Roller Bearings with Thrust Roller Bearing

In this series, needle roller bearings are combined with thrust roller bearings to receive thrust loads.

Their axial load ratings are greater than those of bearings that are combined with thrust ball bearings. Also, elastic deformation of the rolling contact surfaces under load is minimal. Furthermore, the thrust bearing section is finished to high accuracy, and therefore high rotational accuracy is obtained in the case of both vertical and horizontal shafts.

Like the needle roller bearings with thrust ball bearing, this series also includes bearings with a dust cover and bearings with an inner ring.

Needle Roller Bearings with Angular Contact Ball Bearing

In this series, caged needle roller bearings are combined with angular contact ball bearings to receive thrust loads. These bearings conform to the international dimension series #59, which is based on the ISO Standard. They can withstand heavy radial loads and unidirectional axial loads simultaneously.

When the axial load exceeds 25% of the radial load, the radial load will be induced in the angular contact ball bearing, and bearing life will be affected. The relationship between the two loads must therefore be taken into careful consideration.

Needle Roller Bearings with Three-point Contact Ball Bearing

These bearings can withstand heavy radial loads and bi-directional axial loads at the same time during high-speed rotation.

Since the non-interchangeable inner rings are separated at the center of the ball raceway surface, they must be firmly tightened against the shaft in the axial direction. The axial clearance of this bearing is 0.1~0.3 mm, and like NATA59, the axial load should not exceed 25% of the radial load.

Identification Number

The identification number of Combined Type Needle Roller Bearings consists of a model code, dimensions, any supplemental codes and a classification symbol. Some examples are shown below.

Examples of identification number

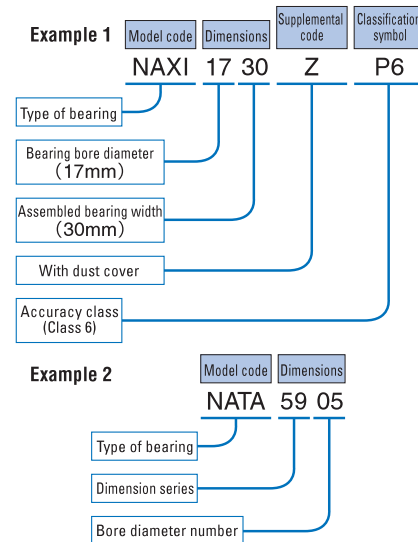

Accuracy

Dimensional accuracy and rotational accuracy of Combined Type Needle Roller Bearings are based on Table 2 below and Tables 12 and 13 on page A31. Thickness variations of thrust rings of NAX(I) and NBX(I) are based on Table 2.4 on page F5. Bore diameter of the small width inner ring of NATB59 is made for a transition fit with k5 tolerance shaft.

Table 2 Tolerances

Type of bearing	Item	Dimension	Dimension symbol	Tolerance
NAX(I) ⁽¹⁾ NBX(I) ⁽¹⁾	Bore dia. of bearing ring for thrust bearing		d_i	E7
	Assembled bearing width		L	0 -0.25
	Bearing height of thrust bearing		H	0 -0.20
NATB59	Width of inner ring		B	0 -0.3

Note⁽¹⁾ Also applicable to bearings with dust cover

Clearance

Combined Type Needle Roller Bearings are manufactured to have the radial internal clearance CN shown in Table 18 on page A37.

Fit

The recommended fits for Combined Type Needle Roller Bearings are shown in Table 3.

Table 3 Recommended fits

Type of bearing	Item	Tolerance class		
		Shaft		Housing bore
		Without inner ring	With inner ring	
NAX(I) ⁽¹⁾ NBX(I) ⁽¹⁾	h5, k5	k5	K6, M6	
NATA59 NATB59	—	k5 ⁽²⁾	M6 ⁽²⁾	

Notes⁽¹⁾ The housing bore for the thrust bearing must be machined to be more than 0.5 mm larger than the outside diameters D_1 and D_2 to ensure that it does not incur radial loads.

⁽²⁾ If the fit is made tighter than specified in this table, radial loads will act upon the thrust bearing, limiting its function.

Lubrication

Grease is not prepacked in Combined Type Needle Roller Bearings, so perform proper lubrication for use. Operating without lubrication will increase the wear of the rolling contact surfaces and shorten the bearing life.

Oil Hole

The outer ring of Combined Type Needle Roller Bearings has an oil groove and an oil hole. When outer rings with multiple oil holes or inner rings with oil hole(s) are required, please contact

Rating Life

In Combined Type Needle Roller Bearings, caged needle roller bearings are subjected to radial loads while thrust bearings receive axial loads. Therefore, it is necessary to calculate their lives respectively (page A17).

Mounting

Fig.1 shows mounting examples of Combined Type Needle Roller Bearings. When applying preload to the NAX and NBX models, it is recommended that thrust raceway rings are not tightened directly with nuts, but are tightened using springs as shown in Fig. 2.

Mounting two NATA models symmetrically allows them to be subjected to two-way axial loads. When mounting these models, an axial clearance of 0.2~0.3 mm should be provided in the angular contact ball bearings so that radial loads are not applied to the angular contact ball bearings.

Dimensions related to mounting should be based on the table of dimensions.

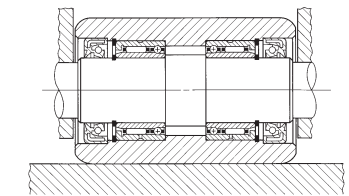
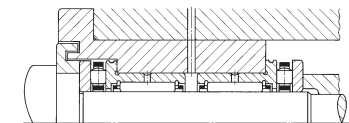

Fig.1 Mounting examples

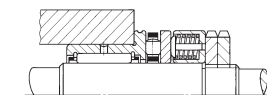

Fig.2 Mounting example when applying preload

1N=0.102kgf=0.2248lbs.
1mm=0.03937inch

COMBINED TYPE NEEDLE ROLLER BEARINGS

Needle Roller Bearings with Thrust Ball Bearing
Needle Roller Bearings with Thrust Roller Bearing

Without Inner Ring
Without Inner Ring

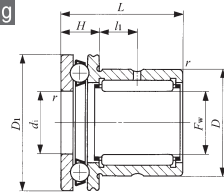

NAX

Shaft dia. 10 – 70mm

Shaft dia. mm	Identification number							
	Mass (Ref.) g	With dust cover	Mass (Ref.) g	Mass (Ref.) g	With dust cover	Mass (Ref.) g	With dust cover	Mass (Ref.) g
10	NAX 1023	38.5	NAX 1023Z	40	—	—	—	—
12	NAX 1223	43.5	NAX 1223Z	45.5	—	—	—	—
15	NAX 1523	47.5	NAX 1523Z	48.5	—	—	—	—
	—	—	—	—	NBX 1523	54	NBX 1523Z	55
17	NAX 1725	54	NAX 1725Z	56	—	—	—	—
	—	—	—	—	NBX 1725	61	NBX 1725Z	63
20	NAX 2030	85.5	NAX 2030Z	89	—	—	—	—
	—	—	—	—	NBX 2030	94	NBX 2030Z	97.5
25	NAX 2530	131	NAX 2530Z	135	—	—	—	—
	—	—	—	—	NBX 2530	143	NBX 2530Z	147
30	NAX 3030	145	NAX 3030Z	151	—	—	—	—
	—	—	—	—	NBX 3030	160	NBX 3030Z	166
35	NAX 3530	169	NAX 3530Z	176	—	—	—	—
	—	—	—	—	NBX 3530	186	NBX 3530Z	193
40	NAX 4032	219	NAX 4032Z	227	—	—	—	—
	—	—	—	—	NBX 4032	240	NBX 4032Z	248
45	NAX 4532	264	NAX 4532Z	273	—	—	—	—
	—	—	—	—	NBX 4532	293	NBX 4532Z	302
50	NAX 5035	287	NAX 5035Z	297	—	—	—	—
	—	—	—	—	NBX 5035	315	NBX 5035Z	325
60	NAX 6040	417	NAX 6040Z	454	—	—	—	—
	—	—	—	—	NBX 6040	501	NBX 6040Z	538
70	NAX 7040	555	NAX 7040Z	606	—	—	—	—

Notes⁽¹⁾ Minimum allowable value of chamfer dimension r
⁽²⁾ Allowable rotational speed applies to oil lubrication. For grease lubrication, a maximum of 70% of this value is allowable in the NAX series, and a maximum of 25% of this value is allowable in the NBX series.

Remarks1. The outer ring has an oil groove and an oil hole.
2. Grease is not prepacked. Perform proper lubrication.

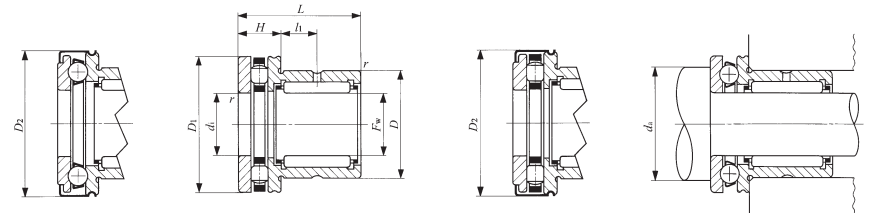

NAX...Z

NBX

NBX...Z

F_w	Boundary dimensions mm										Standard mounting dimension d_a Min. mm	Basic dynamic load rating C		Basic static load rating C_0		Allowable rotational speed ⁽²⁾ rpm
	D	D_1	D_2	L	H	l_1	r_s min	d_i	Radial N	Axial N		Radial N	Axial N			
10	19	24	25	23	9	6.5	0.3	10	18	8 230	10 000	9 190	11 100	9 500		
12	21	26	27	23	9	6.5	0.3	12	20	9 250	9 670	11 200	11 100	9 000		
15	24	28	29	23	9	6.5	0.3	15	23	12 300	9 930	14 900	12 200	8 500		
15	24	28	29	23	9	6.5	0.3	15	26	12 300	10 200	14 900	23 900	14 000		
17	26	30	31	25	9	8	0.3	17	25	12 900	10 800	16 300	14 500	8 500		
17	26	30	31	25	9	8	0.3	17	28	12 900	11 400	16 300	28 600	13 000		
20	30	35	36	30	10	10.5	0.3	20	29	17 600	14 200	25 400	19 700	7 500		
20	30	35	36	30	10	10.5	0.3	20	33	17 600	19 000	25 400	48 700	11 000		
25	37	42	43	30	11	9.5	0.6	25	35	20 000	19 600	32 100	29 700	7 000		
25	37	42	43	30	11	9.5	0.6	25	40	20 000	22 700	32 100	60 700	9 000		
30	42	47	48	30	11	9.5	0.6	30	40	25 100	20 400	40 100	33 600	6 500		
30	42	47	48	30	11	9.5	0.6	30	45	25 100	27 400	40 100	81 000	8 000		
35	47	52	53	30	12	9	0.6	35	45	26 900	21 200	46 200	37 600	6 000		
35	47	52	53	30	12	9	0.6	35	50	26 900	29 100	46 200	91 100	7 000		
40	52	60	61	32	13	10	0.6	40	52	29 400	26 900	54 100	50 000	5 500		
40	52	60	61	32	13	10	0.6	40	57	29 400	41 700	54 100	133 000	6 000		
45	58	65	66.5	32	14	9	0.6	45	57	31 000	27 900	60 200	55 100	5 000		
45	58	65	66.5	32	14	9	0.6	45	62	31 000	40 800	60 200	133 000	5 500		
50	62	70	71.5	35	14	10	0.6	50	62	42 200	28 800	83 400	60 100	4 500		
50	62	70	71.5	35	14	10	0.6	50	67	42 200	43 300	83 400	148 000	5 000		
60	72	85	86.5	40	17	12	1	60	75	47 500	41 400	103 000	89 700	4 000		
60	72	85	86.5	40	17	12	1	60	82	47 500	64 600	103 000	224 000	4 000		
70	85	95	96.5	40	18	11	1	70	85	55 500	43 100	120 000	101 000	3 500		

1N=0.102kgf=0.2248lbs.
1mm=0.03937inch

COMBINED TYPE NEEDLE ROLLER BEARINGS

Needle Roller Bearings with Thrust Ball Bearing
Needle Roller Bearings with Thrust Roller Bearing

With Inner Ring
With Inner Ring

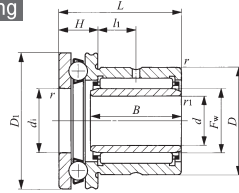

Shaft dia. 7 – 60mm

NAXI

Shaft dia. mm	Identification number								d	D	D ₁
	Mass (Ref.) g	With dust cover	Mass (Ref.) g		Mass (Ref.) g	With dust cover	Mass (Ref.) g				
7	NAXI 723	43.5	NAXI 723Z	45	—	—	—	—	7	19	24
9	NAXI 923	49.5	NAXI 923Z	51.5	—	—	—	—	9	21	26
12	NAXI 1223	55.5	NAXI 1223Z	56.5	—	—	—	—	12	24	28
	—	—	—	—	NBXI 1223	62	NBXI 1223Z	63	12	24	28
14	NAXI 1425	63.5	NAXI 1425Z	65.5	—	—	—	—	14	26	30
	—	—	—	—	NBXI 1425	70.5	NBXI 1425Z	72.5	14	26	30
17	NAXI 1730	99	NAXI 1730Z	103	—	—	—	—	17	30	35
	—	—	—	—	NBXI 1730	108	NBXI 1730Z	111	17	30	35
20	NAXI 2030	159	NAXI 2030Z	163	—	—	—	—	20	37	42
	—	—	—	—	NBXI 2030	171	NBXI 2030Z	175	20	37	42
25	NAXI 2530	179	NAXI 2530Z	185	—	—	—	—	25	42	47
	—	—	—	—	NBXI 2530	194	NBXI 2530Z	200	25	42	47
30	NAXI 3030	208	NAXI 3030Z	215	—	—	—	—	30	47	52
	—	—	—	—	NBXI 3030	225	NBXI 3030Z	232	30	47	52
35	NAXI 3532	265	NAXI 3532Z	273	—	—	—	—	35	52	60
	—	—	—	—	NBXI 3532	286	NBXI 3532Z	294	35	52	60
40	NAXI 4032	315	NAXI 4032Z	324	—	—	—	—	40	58	65
	—	—	—	—	NBXI 4032	344	NBXI 4032Z	353	40	58	65
45	NAXI 4535	358	NAXI 4535Z	368	—	—	—	—	45	62	70
	—	—	—	—	NBXI 4535	386	NBXI 4535Z	396	45	62	70
50	NAXI 5040	582	NAXI 5040Z	619	—	—	—	—	50	72	85
	—	—	—	—	NBXI 5040	666	NBXI 5040Z	703	50	72	85
60	NAXI 6040	750	NAXI 6040Z	801	—	—	—	—	60	85	95

Notes⁽¹⁾ Minimum allowable value of chamfer dimension r or r_1

⁽²⁾ Allowable rotational speed applies to oil lubrication. For grease lubrication, a maximum of 70% of this value is allowable in the NAXI series, and a maximum of 25% of this value is allowable in the NBXI series.

Remarks1. The outer ring has an oil groove and an oil hole.
2. Grease is not prepacked. Perform proper lubrication.

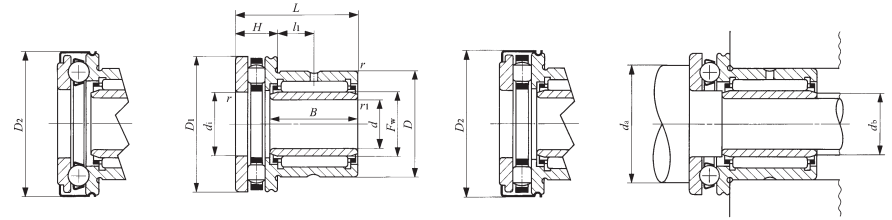

NAXI...Z

NBXI

NBXI...Z

D ₂	Boundary dimensions mm										Standard mounting dimensions mm		Basic dynamic load rating C		Basic static load rating C ₀		Allowable rotational speed ⁽²⁾ rpm	Assembled inner ring
	L	B	H	l ₁	r _{s min} ⁽¹⁾	r _{1s min} ⁽¹⁾	F _w	d _i	d _a Min.	d _b	Radial N	Axial N	Radial N	Axial N				
25	23	16	9	6.5	0.3	0.2	10	10	18	9	8 230	10 000	9 190	11 100	9 500	LRT 71016		
27	23	16	9	6.5	0.3	0.3	12	12	20	11	9 250	9 670	11 200	11 100	9 000	LRT 91216		
29	23	16.5	9	6.5	0.3	0.3	15	15	23	14	12 300	9 930	14 900	12 200	8 500	LRT 121516		
29	23	16.5	9	6.5	0.3	0.3	15	15	26	14	12 300	10 200	14 900	23 900	14 000	LRT 121516		
31	25	17	9	8	0.3	0.3	17	17	25	16	12 900	10 800	16 300	14 500	8 500	LRT 141717		
31	25	17	9	8	0.3	0.3	17	17	28	16	12 900	11 400	16 300	28 600	13 000	LRT 141717		
36	30	20.5	10	10.5	0.3	0.3	20	20	29	19	17 600	14 200	25 400	19 700	7 500	LRT 172020		
36	30	20.5	10	10.5	0.3	0.3	20	20	33	19	17 600	19 000	25 400	48 700	11 000	LRT 172020		
43	30	20.5	11	9.5	0.6	0.3	25	25	35	24	20 000	19 600	32 100	29 700	7 000	LRT 202520		
43	30	20.5	11	9.5	0.6	0.3	25	25	40	24	20 000	22 700	32 100	60 700	9 000	LRT 202520		
48	30	20.5	11	9.5	0.6	0.3	30	30	40	29	25 100	20 400	40 100	33 600	6 500	LRT 253020		
48	30	20.5	11	9.5	0.6	0.3	30	30	45	29	25 100	27 400	40 100	81 000	8 000	LRT 253020		
53	30	20	12	9	0.6	0.3	35	35	45	34	26 900	21 200	46 200	37 600	6 000	LRT 303520		
53	30	20	12	9	0.6	0.3	35	35	50	34	26 900	29 100	46 200	91 100	7 000	LRT 303520		
61	32	20	13	10	0.6	0.3	40	40	52	39	29 400	26 900	54 100	50 000	5 500	LRT 354020		
61	32	20	13	10	0.6	0.3	40	40	57	39	29 400	41 700	54 100	133 000	6 000	LRT 354020		
66.5	32	20	14	9	0.6	0.3	45	45	57	44	31 000	27 900	60 200	55 100	5 000	LRT 404520		
66.5	32	20	14	9	0.6	0.3	45	45	62	44	31 000	40 800	60 200	133 000	5 500	LRT 404520		
71.5	35	25	14	10	0.6	0.3	50	50	62	49	42 200	28 800	83 400	60 100	4 500	LRT 455025		
71.5	35	25	14	10	0.6	0.3	50	50	67	49	42 200	43 300	83 400	148 000	5 000	LRT 455025		
86.5	40	25.5	17	12	1	1	60	60	75	59	47 500	41 400	103 000	89 700	4 000	LRT 506025		
86.5	40	25.5	17	12	1	1	60	60	82	59	47 500	64 600	103 000	224 000	4 000	LRT 506025		
96.5	40	25.5	18	11	1	1	70	70	85	68	55 500	43 100	120 000	101 000	3 500	LRT 607025		

1N=0.102kgf=0.2248lbs.
1mm=0.03937inch

COMBINED TYPE NEEDLE ROLLER BEARINGS

Needle Roller Bearings with Angular Contact Ball Bearing
Needle Roller Bearings with Three-point Contact Ball Bearing

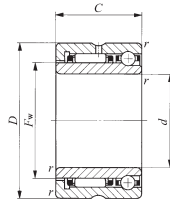

NATA59

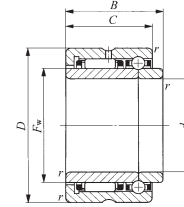

NATB59

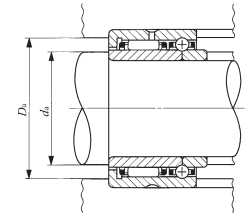
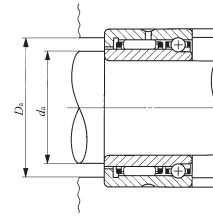

Shaft dia. 15 – 70mm

Shaft dia. mm	Identification number				Boundary dimensions mm					
	Angular contact type	Mass (Ref.) g	Three-point contact type	Mass (Ref.) g	d	D	C	B	$r_{s\min}^{(1)}$	F_w
15	NATA 5902	50.5	NATB 5902	53	15	28	18	20	0.3	20
17	NATA 5903	55.5	NATB 5903	58.5	17	30	18	20	0.3	22
20	NATA 5904	111	NATB 5904	115	20	37	23	25	0.3	25
25	NATA 5905	131	NATB 5905	136	25	42	23	25	0.3	30
30	NATA 5906	151	NATB 5906	157	30	47	23	25	0.3	35
35	NATA 5907	250	NATB 5907	260	35	55	27	30	0.6	42
40	NATA 5908	355	NATB 5908	375	40	62	30	34	0.6	48
45	NATA 5909	410	NATB 5909	435	45	68	30	34	0.6	55
50	NATA 5910	420	NATB 5910	445	50	72	30	34	0.6	58
55	NATA 5911	585	NATB 5911	615	55	80	34	38	1	63
60	NATA 5912	625	NATB 5912	660	60	85	34	38	1	68
65	NATA 5913	665	NATB 5913	710	65	90	34	38	1	75
70	NATA 5914	1 070	NATB 5914	1 130	70	100	40	45	1	80

Notes⁽¹⁾ Minimum allowable value of chamfer dimension r
⁽²⁾ Allowable rotational speed applies to oil lubrication. For grease lubrication, a maximum of 60% of this value is allowable.
 Remarks1. The outer ring has an oil groove and an oil hole.
 2. Grease is not prepacked. Perform proper lubrication.

Standard mounting dimensions mm		Basic dynamic load rating C		Basic static load rating C_0		Allowable rotational speed ⁽²⁾ rpm
d_a Min.	D_a Max.	Radial N	Axial N	Radial N	Axial N	
17	26	7 710	1 900	10 200	2 920	20 000
19	28	8 220	2 050	11 500	3 340	18 000
22	35	14 300	3 810	18 400	6 110	16 000
27	40	15 800	4 300	22 100	7 520	13 000
32	45	17 700	4 550	26 800	8 460	11 000
39	51	24 000	4 890	42 100	9 870	9 500
44	58	30 600	5 350	60 400	11 800	8 500
49	64	32 600	5 450	68 500	12 700	7 000
54	68	33 600	5 660	72 500	13 600	7 000
60	75	39 500	10 400	74 400	24 700	6 500
65	80	41 800	10 700	82 200	26 700	6 000
70	85	43 800	11 000	90 200	28 700	5 500
75	95	56 400	13 500	127 000	35 000	5 000

1N=0.102kgf=0.2248lbs.
1mm=0.03937inch

INNER RINGS

- Inner Rings for Shell Type Needle Roller Bearings
- Inner Rings for General Usage



Structure and Features

TURNUP Inner Rings are heat-treated and finished by grinding to a high degree of accuracy. In the case of needle roller bearings, normally, the shafts are heat-treated and finished by grinding, and used as the raceway surfaces. However, when it is impossible to make shaft surfaces according to the specified surface hardness or surface roughness, inner rings are used.

Inner rings include those for Shell Type Needle Roller Bearings and those for general use and are available in a variety of dimensions. When shafts move axially or seals are used adjacent to bearings, wide inner rings can be selected.

Inner rings can also be used economically as bushings without requiring any additional machining.

Types

For Inner Rings, the types shown in Table 1 are available.

Table 1.1 Inner Rings for Shell Type Needle Roller Bearings

Series		Model codes of assembled bearings
Metric series	IRT	TA...Z, TLA...Z TAM, TLAM, YT, YTL
Inch series	IRB	BA...Z, BHA...Z BAM, BHAM, YB, YBH

Table 1.2 Inner Rings for General Usage

Series		Model codes of assembled bearings
Metric series	LRT	RNA 49, RNA 69 RNA 48, TAF, TR RNAF, NAX, NBX
	LRTZ	RNA 49...UU, RNA 69...UU GTR
Inch series	LRB	BR
	LRBZ...B	BR...UU
	LRBZ	GBR, GBR...UU

Shapes of Inner Rings

IRT
IRB
LRT

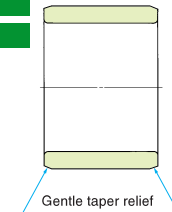

LRTZ
LRBZ

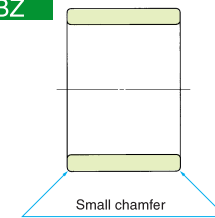

LRB

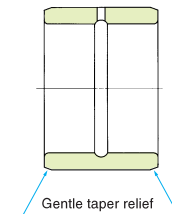

LRBZ...B

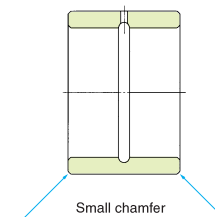

H

IRT
IRB
LRT
LRB

INNER RINGS

Inner Rings for Shell Type Needle Roller Bearings



Shaft dia. 7 – 17mm

Shaft dia. mm	Identification number	Mass (Ref.) g	Boundary dimensions mm				Standard mounting dimension mm		Assembled bearings		
			<i>d</i>	<i>F</i>	<i>B</i>	<i>r_s</i> ⁽¹⁾ min	Min.	Max.	TA···Z (TAM)	TLA···Z (TLAM)	YT YTL
7	IRT 710	3.2	7	10	10.5	0.3	9	9.7	TA 1010Z	TLA 1010Z	—
	IRT 712	3.9	7	10	12.5	0.3	9	9.7	TA 1012Z	TLA 1012Z	—
	IRT 715	4.8	7	10	15.5	0.3	9	9.7	TA 1015Z	TLA 1015Z	—
8	IRT 810	5.1	8	12	10.5	0.3	10	11	—	TLA 1210Z	YTL 1210
	IRT 812	6	8	12	12.5	0.3	10	11	TA 1212Z	TLA 1212Z	YT 1212
	IRT 815	7.5	8	12	15.5	0.3	10	11	TA 1215Z	—	—
10	IRT 1012	5.2	10	13	12.5	0.3	12	12.7	—	TLA 1312Z	—
	IRT 1012-2	7.2	10	14	12.5	0.3	12	13	—	TLA 1412Z	—
	IRT 1016-2	9.6	10	14	16.5	0.3	12	13	TA 1416Z	TLA 1416Z	—
	IRT 1020-2	11.9	10	14	20.5	0.3	12	13	TA 1420Z	—	—
	IRT 1010-1	7.9	10	15	10.5	0.3	12	14	TA 1510Z	—	—
	IRT 1012-1	9.4	10	15	12.5	0.3	12	14	TA 1512Z	TLA 1512Z	—
	IRT 1015-1	11.7	10	15	15.5	0.3	12	14	TA 1515Z	—	—
	IRT 1020-1	15.5	10	15	20.5	0.3	12	14	TA 1520Z	—	—
	IRT 1025-1	19.3	10	15	25.5	0.3	12	14	TA 1525Z	—	—
12	IRT 1212	6.1	12	15	12.5	0.3	14	14.5	TA 1512Z	TLA 1512Z	—
	IRT 1216	8.1	12	15	16.5	0.3	14	14.5	—	TLA 1516Z	—
	IRT 1222	11	12	15	22.5	0.3	14	14.5	—	TLA 1522Z	—
	IRT 1212-1	8.5	12	16	12.5	0.3	14	15	—	TLA 1612Z	—
	IRT 1216-1	11.2	12	16	16.5	0.3	14	15	TA 1616Z	TLA 1616Z	—
	IRT 1220-1	13.9	12	16	20.5	0.3	14	15	TA 1620Z	—	—
	IRT 1222-1	15.2	12	16	22.5	0.3	14	15	—	TLA 1622Z	—
	IRT 1215-2	13.6	12	17	15.5	0.3	14	16	TA 1715Z	—	YT 1715
	IRT 1220-2	18	12	17	20.5	0.3	14	16	TA 1720Z	—	—
	IRT 1225-2	22.5	12	17	25.5	0.3	14	16	TA 1725Z	—	YT 1725
15	IRT 1512	7.5	15	18	12.5	0.3	17	17.5	—	TLA 1812Z	—
	IRT 1513	8.1	15	18	13.5	0.3	17	17.5	TA 1813Z	—	—

Note(1) Minimum allowable value of chamfer dimension *r*
Remark No oil hole is provided.

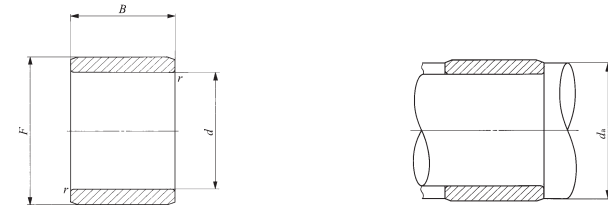

IRT

Shaft dia. mm	Identification number	Mass (Ref.) g	Boundary dimensions mm				Standard mounting dimension mm		Assembled bearings		
			<i>d</i>	<i>F</i>	<i>B</i>	<i>r_s</i> ⁽¹⁾ min	Min.	Max.	TA···Z (TAM)	TLA···Z (TLAM)	YT YTL
15	IRT 1515	9.3	15	18	15.5	0.3	17	17.5	TA 1815Z	—	—
	IRT 1516	9.9	15	18	16.5	0.3	17	17.5	—	TLA 1816Z	—
	IRT 1517	10.5	15	18	17.5	0.3	17	17.5	TA 1817Z	—	—
	IRT 1519	11.7	15	18	19.5	0.3	17	17.5	TA 1819Z	—	—
	IRT 1520	12.3	15	18	20.5	0.3	17	17.5	TA 1820Z	—	—
	IRT 1525	15.2	15	18	25.5	0.3	17	17.5	TA 1825Z	—	—
	IRT 1516-1	13.6	15	19	16.5	0.3	17	18	TA 1916Z	—	—
	IRT 1520-1	16.8	15	19	20.5	0.3	17	18	TA 1920Z	—	—
	IRT 1515-2	16.4	15	20	15.5	0.3	17	19	TA 2015Z	—	YT 2015
	IRT 1520-2	21.5	15	20	20.5	0.3	17	19	TA 2020Z	TLA 2020Z	YT 202820
	IRT 1525-2	27	15	20	25.5	0.3	17	19	TA 2025Z	—	YT 2025
	IRT 1530-2	32	15	20	30.5	0.3	17	19	TA 2030Z	TLA 2030Z	—
17	IRT 1716	11.1	17	20	16.5	0.3	19	19.5	—	TLA 2016Z	—
	IRT 1720	13.7	17	20	20.5	0.3	19	19.5	TA 2020Z	TLA 2020Z	YT 202820
	IRT 1730	20.5	17	20	30.5	0.3	19	19.5	TA 202820Z	—	—
	IRT 1716-1	15.1	17	21	16.5	0.3	19	20	TA 2030Z	TLA 2030Z	—
	IRT 1720-1	18.8	17	21	20.5	0.3	19	20	TA 2116Z	—	YT 2116
	IRT 1710-2	12.4	17	22	10.5	0.3	19	21	TA 2120Z	—	YT 2120
	IRT 1715-2	18.3	17	22	15.5	0.3	19	21	TA 2210Z	—	—
	IRT 1716-2	19.4	17	22	16.5	0.3	19	21	TA 2215Z	—	—
	IRT 1720-2	24	17	22	20.5	0.3	19	21	TA 223016Z	TLA 2216Z	YT 223016
	IRT 1725-2	30	17	22	25.5	0.3	19	21	TA 2220Z	TLA 2220Z	YT 223020
	IRT 1730-2	36	17	22	30.5	0.3	19	21	TA 223020Z	—	—
	IRT 1725-2	30	17	22	25.5	0.3	19	21	TA 2225Z	—	—
IRT 1730-2	36	17	22	30.5	0.3	19	21	TA 2230Z	—	—	

Note(1) Minimum allowable value of chamfer dimension *r*
Remark No oil hole is provided.

1N=0.102kgf=0.2248lbs.
1mm=0.03937inch

INNER RINGS

Inner Rings for Shell Type Needle Roller Bearings

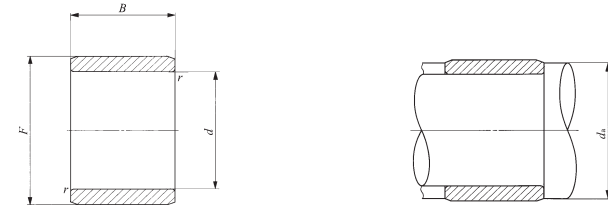

IRT

Shaft dia. 20 – 45mm

Shaft dia. mm	Identification number	Mass (Ref.) g	Boundary dimensions mm				Standard mounting dimension mm		Assembled bearings		
			d	F	B	r _s ⁽¹⁾	Min.	Max.	TA···Z (TAM)	TLA···Z (TLAM)	YT YTL
20	IRT 2016	17.5	20	24	16.5	0.3	22	23	TA 243216Z	—	YT 243216
	IRT 2020	22	20	24	20.5	0.3	22	23	TA 2420Z	—	YT 243220
									TA 243220Z	—	—
	IRT 2028	30.5	20	24	28.5	0.3	22	23	TA 2428Z	—	YT 2428
	IRT 2010-1	14.3	20	25	10.5	0.3	22	24	TA 2510Z	—	YT 2510
	IRT 2015-1	21	20	25	15.5	0.3	22	24	TA 2515Z	—	YT 2515
	IRT 2020-1	28	20	25	20.5	0.3	22	24	TA 2520Z	TLA 2520Z	YT 2520
	IRT 2025-1	34.5	20	25	25.5	0.3	22	24	TA 2525Z	—	YT 2525
	IRT 2026-1	36	20	25	26.5	0.3	22	24	—	TLA 2526Z	YTL 2526
22	IRT 2030-1	41.5	20	25	30.5	0.3	22	24	TA 2530Z	—	—
	IRT 2038-1	52.5	20	25	38.5	0.3	22	24	—	TLAW 2538Z	—
									—	—	—
22	IRT 2216	19.1	22	26	16.5	0.3	24	25	TA 2616Z	—	YT 2616
	IRT 2220	24	22	26	20.5	0.3	24	25	TA 2620Z	—	YT 2620
	IRT 2220-1	37	22	28	20.5	0.3	24	27	TA 2820Z	TLA 2820Z	YT 2820
	IRT 2230-1	55.5	22	28	30.5	0.3	24	27	TA 2830Z	—	—
25	IRT 2520	26.5	25	29	20.5	0.3	27	28	TA 2920Z	—	YT 2920
	IRT 2530	40	25	29	30.5	0.3	27	28	TA 2930Z	—	—
	IRT 2515-1	25.5	25	30	15.5	0.3	27	29	TA 3015Z	—	—
	IRT 2520-1	34	25	30	20.5	0.3	27	29	TA 3020Z	TLA 3020Z	—
	IRT 2525-1	42.5	25	30	25.5	0.3	27	29	TA 3025Z	—	—
	IRT 2526-1	44	25	30	26.5	0.3	27	29	—	TLA 3026Z	—
	IRT 2530-1	50.5	25	30	30.5	0.3	27	29	TA 3030Z	—	—
	IRT 2538-1	64	25	30	38.5	0.3	27	29	—	TLAW 3038Z	—
28	IRT 2820	29.5	28	32	20.5	0.3	30	31	TA 3220Z	—	YT 3220
	IRT 2830	44	28	32	30.5	0.3	30	31	TA 3230Z	—	—
30	IRT 3012	24.5	30	35	12.5	0.6	34	34.5	TA 3512Z	TLA 3512Z	—
	IRT 3015	30.5	30	35	15.5	0.6	34	34.5	TA 3515Z	—	—

Note⁽¹⁾ Minimum allowable value of chamfer dimension r
Remark No oil hole is provided.

Shaft dia. mm	Identification number	Mass (Ref.) g	Boundary dimensions mm				Standard mounting dimension mm		Assembled bearings		
			d	F	B	r _s ⁽¹⁾	Min.	Max.	TA···Z (TAM)	TLA···Z (TLAM)	YT YTL
30	IRT 3020	40	30	35	20.5	0.6	34	34.5	TA 3520Z	TLA 3520Z	—
	IRT 3025	50	30	35	25.5	0.6	34	34.5	TA 3525Z	—	—
	IRT 3030	60	30	35	30.5	0.6	34	34.5	TA 3530Z	—	—
32	IRT 3220	42.5	32	37	20.5	0.6	36	36.5	TA 3720Z	—	YT 3720
	IRT 3230	63.5	32	37	30.5	0.6	36	36.5	TA 3730Z	—	—
	IRT 3215-1	39.5	32	38	15.5	0.6	36	37	TA 3815Z	—	—
	IRT 3220-1	52	32	38	20.5	0.6	36	37	TA 3820Z	—	—
	IRT 3225-1	64.5	32	38	25.5	0.6	36	37	TA 3825Z	—	—
	IRT 3230-1	77.5	32	38	30.5	0.6	36	37	TA 3830Z	—	—
	IRT 3245-1	115	32	38	45.5	0.6	36	37	TAW 3845Z	—	—
35	IRT 3515	35	35	40	15.5	0.6	39	39.5	TA 4015Z	—	YT 4015
	IRT 3520	46.5	35	40	20.5	0.6	39	39.5	TA 4020Z	TLA 4020Z	—
	IRT 3525	58	35	40	25.5	0.6	39	39.5	TA 4025Z	—	YT 4025
	IRT 3530	69	35	40	30.5	0.6	39	39.5	TA 4030Z	—	—
	IRT 3540	91.5	35	40	40.5	0.6	39	39.5	TA 4040Z	—	—
40	IRT 4020	52.5	40	45	20.5	0.6	44	45.5	TA 4520Z	TLA 4520Z	YT 4520
	IRT 4025	65.5	40	45	25.5	0.6	44	45.5	TA 4525Z	—	YT 4525
	IRT 4030	78.5	40	45	30.5	0.6	44	45.5	TA 4530Z	—	—
	IRT 4040	104	40	45	40.5	0.6	44	45.5	TA 4540Z	—	—
45	IRT 4512	36	45	50	12.5	0.6	49	49.5	TA 5012Z	—	—
	IRT 4515	44.5	45	50	15.5	0.6	49	49.5	TA 5015Z	—	—
	IRT 4520	59	45	50	20.5	0.6	49	49.5	TA 5020Z	TLA 5020Z	—
	IRT 4525	73	45	50	25.5	0.6	49	49.5	TA 5025Z	TLA 5025Z	—
	IRT 4530	87.5	45	50	30.5	0.6	49	49.5	TA 5030Z	—	—
	IRT 4540	116	45	50	40.5	0.6	49	49.5	TA 5040Z	—	—
	IRT 4545	131	45	50	45.5	0.6	49	49.5	TAW 5045Z	—	—

Note⁽¹⁾ Minimum allowable value of chamfer dimension r
Remark No oil hole is provided.

1N=0.102kgf=0.2248lbs.
1mm=0.03937inch

INNER RINGS

Inner Rings for Shell Type Needle Roller Bearings

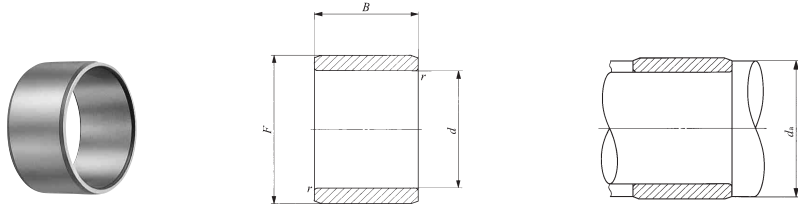

IRT

Shaft dia. 50 – 60mm

Shaft dia. mm	Identification number	Mass (Ref.) g	Boundary dimensions mm				Standard mounting dimension mm		Assembled bearings		
			d	F	B	r _s min ⁽¹⁾	Min.	Max.	TA...Z (TAM)	TLA...Z (TLAM)	YT YTL
50	IRT 5020-1	65	50	55	20.5	0.6	54	54.5	TA 5520Z	TLA 5520Z	—
	IRT 5025-1	81	50	55	25.5	0.6	54	54.5	TA 5525Z	TLA 5525Z	—
	IRT 5030-1	96.5	50	55	30.5	0.6	54	54.5	TA 5530Z	—	—
	IRT 5040-1	128	50	55	40.5	0.6	54	54.5	TA 5540Z	—	—
	IRT 5045-1	144	50	55	45.5	0.6	54	54.5	TAW 5545Z	—	—
	IRT 5050-1	160	50	55	50.5	0.6	54	54.5	TAW 5550Z	—	—
	IRT 5025	169	50	60	25.5	1.5	58	59	TA 6025Z	—	—
	IRT 5030	205	50	60	30.5	1.5	58	59	TA 6030Z	—	—
	IRT 5040	270	50	60	40.5	1.5	58	59	TA 6040Z	—	—
	IRT 5045	300	50	60	45.5	1.5	58	59	TAW 6045Z	—	—
IRT 5050	335	50	60	50.5	1.5	58	59	TAW 6050Z	—	—	
52	IRT 5212	86	52	62	12.5	1.5	60	60.5	TA 6212Z	—	—
55	IRT 5525	185	55	65	25.5	1.5	63	63.5	TA 6525Z	—	—
	IRT 5530	220	55	65	30.5	1.5	63	63.5	TA 6530Z	—	—
	IRT 5545	330	55	65	45.5	1.5	63	63.5	TAW 6545Z	—	—
	IRT 5550	365	55	65	50.5	1.5	63	63.5	TAW 6550Z	—	—
60	IRT 6025	200	60	70	25.5	1.5	68	68.5	TA 7025Z	—	—
	IRT 6030	240	60	70	30.5	1.5	68	68.5	TA 7030Z	—	—
	IRT 6040	320	60	70	40.5	1.5	68	68.5	TA 7040Z	—	—
	IRT 6050	395	60	70	50.5	1.5	68	68.5	TAW 7050Z	—	—

Note(1) Minimum allowable value of chamfer dimension r
Remark No oil hole is provided.

Inner Rings for Shell Type Needle Roller Bearings Inch Series

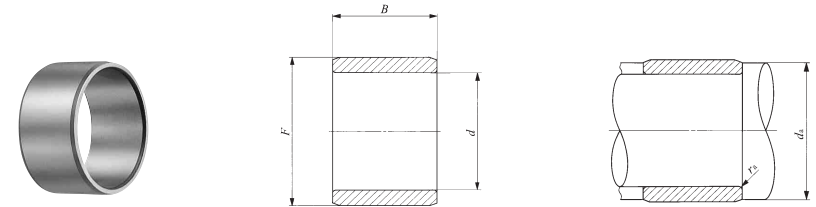

IRB

Shaft dia. 7.938 – 15.875mm

Shaft dia. mm (inch)	Identification number	Mass (Ref.) g	Boundary dimensions mm(inch)			Standard mounting dimensions mm ⁽¹⁾			Assembled bearings		
			d	F	B	d _a Min.	d _a Max.	r _{as} max Max.	BA...Z (BAM)	BHA...Z (BHAM)	YB YBH
7.938 (⁵ / ₁₆)	IRB 58	8	7.938 (⁵ / ₁₆)	12.700 (¹ / ₂)	13.08	11.3	11.7	0.3	BA 88Z	BHA 88Z	YB 88
	IRB 68	8.9	9.525 (³ / ₈)	14.288 (⁹ / ₁₆)	13.08	12.8	13.2	0.3	BA 98Z	BHA 98Z	YB 98
9.525 (³ / ₈)	IRB 68-1	12.6	9.525 (³ / ₈)	15.875 (⁵ / ₈)	13.08	12.8	14	0.3	BA 108Z	BHA 108Z	YB 108
	IRB 612	13.2	9.525 (³ / ₈)	14.288 (⁹ / ₁₆)	19.43	12.8	13.2	0.3	BA 912Z	—	YB 912
	IRB 612-1	18.8	9.525 (³ / ₈)	15.875 (⁵ / ₈)	19.43	12.8	14	0.3	BA 1012Z	BHA 1012Z	YB 1012
	IRB 78	10.1	11.112 (⁷ / ₁₆)	15.875 (⁵ / ₈)	13.08	14.4	14.8	0.3	BA 108Z	BHA 108Z	YB 108
11.112 (⁷ / ₁₆)	IRB 712	15	11.112 (⁷ / ₁₆)	15.875 (⁵ / ₈)	19.43	14.4	14.8	0.3	BA 1012Z	—	YB 1012
	IRB 714	17.4	11.112 (⁷ / ₁₆)	15.875 (⁵ / ₈)	22.60	14.4	14.8	0.3	BA 1014Z	—	—
	IRB 716	19.9	11.112 (⁷ / ₁₆)	15.875 (⁵ / ₈)	25.78	14.4	14.8	0.3	BA 1016Z	BHA 1016Z	—
12.700 (¹ / ₂)	IRB 86	8.5	12.700 (¹ / ₂)	17.462 (¹ / ₂)	9.90	16.9	16.9	0.3	BA 116Z	—	—
	IRB 88	11.2	12.700 (¹ / ₂)	17.462 (¹ / ₂)	13.08	16.9	16.9	0.3	BA 118Z	—	—
	IRB 812	16.7	12.700 (¹ / ₂)	17.462 (¹ / ₂)	19.43	16.9	16.9	0.3	BA 1112Z	—	YB 1112
	IRB 88-1	15.8	12.700 (¹ / ₂)	19.050 (³ / ₄)	13.08	16.9	17.5	0.6	BA 128Z	—	YB 128
	IRB 810-1	19.6	12.700 (¹ / ₂)	19.050 (³ / ₄)	16.25	16.9	17.5	0.6	BA 1210Z	—	YB 1210
	IRB 812-1	23.5	12.700 (¹ / ₂)	19.050 (³ / ₄)	19.43	16.9	17.5	0.6	BA 1212Z	—	YB 1212
	IRB 814-1	27.5	12.700 (¹ / ₂)	19.050 (³ / ₄)	22.60	16.9	17.5	0.6	BA 1214Z	—	—
IRB 816-1	31	12.700 (¹ / ₂)	19.050 (³ / ₄)	25.78	16.9	17.5	0.6	BA 1216Z	—	—	
14.288 (⁹ / ₁₆)	IRB 98	17.3	14.288 (⁹ / ₁₆)	20.638 (⁵ / ₈)	13.08	19	19.6	0.6	BA 138Z	—	YB 138
	IRB 910	21.5	14.288 (⁹ / ₁₆)	20.638 (⁵ / ₈)	16.25	19	19.6	0.6	BA 1310Z	—	YB 1310
	IRB 912	26	14.288 (⁹ / ₁₆)	20.638 (⁵ / ₈)	19.43	19	19.6	0.6	BA 1312Z	BHA 1312Z	YB 1312
	IRB 914	30	14.288 (⁹ / ₁₆)	20.638 (⁵ / ₈)	22.60	19	19.6	0.6	BA 1314Z	—	—
	IRB 916	34.5	14.288 (⁹ / ₁₆)	20.638 (⁵ / ₈)	25.78	19	19.6	0.6	BA 1316Z	—	—
IRB 920	43	14.288 (⁹ / ₁₆)	20.638 (⁵ / ₈)	32.13	19	19.6	0.6	BA 1320Z	—	—	
15.875 (⁵ / ₈)	IRB 106	14.5	15.875 (⁵ / ₈)	22.225 (⁷ / ₈)	9.90	20.7	21.2	0.6	BA 146Z	—	—
	IRB 108	18.9	15.875 (⁵ / ₈)	22.225 (⁷ / ₈)	13.08	20.7	21.2	0.6	BA 148Z	—	YB 148
	IRB 1012	28	15.875 (⁵ / ₈)	22.225 (⁷ / ₈)	19.43	20.7	21.2	0.6	BA 1412Z	BHA 1412Z	YB 1412

Note(1) Maximum allowable fillet corner radius of shaft
Remark No oil hole is provided.

1N=0.102kgf=0.2248lbs.
1mm=0.03937inch

INNER RINGS

Inner Rings for Shell Type Needle Roller Bearings Inch Series



Shaft dia. 15.875 – 63.500mm

Shaft dia. mm (inch)	Identification number	Mass (Ref.) g	Boundary dimensions mm(inch)			Standard mounting dimensions mm (^())			Assembled bearings		
			<i>d</i>	<i>F</i>	<i>B</i>	<i>d_a</i> Min.	<i>r_s</i> Max.	<i>r_s</i> Max.	BA...Z (BAM)	BHA...Z (BHAM)	YB YBH
15.875 (⁵ / ₈)	IRB 1014	33	15.875 (⁵ / ₈)	22.225 (⁷ / ₈)	22.60	20.7	21.2	0.6	BA 1414Z	—	—
	IRB 1016	37.5	15.875 (⁵ / ₈)	22.225 (⁷ / ₈)	25.78	20.7	21.2	0.6	BA 1416Z	BHA 1416Z	YB 1416
	IRB 1022	51.5	15.875 (⁵ / ₈)	22.225 (⁷ / ₈)	35.30	20.7	21.2	0.6	BA 1422Z	—	—
	IRB 1022	51.5	15.875 (⁵ / ₈)	22.225 (⁷ / ₈)	35.30	20.7	21.2	0.6	BA 1422Z	—	—
17.462 (¹¹ / ₁₆)	IRB 1110	25.5	17.462 (¹¹ / ₁₆)	23.812 (¹⁵ / ₁₆)	16.25	22.3	22.8	0.6	BA 1510Z	—	—
	IRB 1116	40.5	17.462 (¹¹ / ₁₆)	23.812 (¹⁵ / ₁₆)	25.78	22.3	22.8	0.6	BA 1516Z	—	—
19.050 (³ / ₄)	IRB 128	22	19.050 (³ / ₄)	25.400 (1)	13.08	23.9	24.4	0.6	BA 168Z	BHA 168Z	YB 168 YBH 168
	IRB 1212	33	19.050 (³ / ₄)	25.400 (1)	19.43	23.9	24.4	0.6	BA 1612Z	BHA 1612Z	YB 1612 YBH 1612
	IRB 1214	38.5	19.050 (³ / ₄)	25.400 (1)	22.60	23.9	24.4	0.6	BA 1614Z	—	—
	IRB 1216	43.5	19.050 (³ / ₄)	25.400 (1)	25.78	23.9	24.4	0.6	BA 1616Z	BHA 1616Z	YB 1616 YBH 1616
	IRB 1220	54.5	19.050 (³ / ₄)	25.400 (1)	32.13	23.9	24.4	0.6	BA 1620Z	—	—
20.638 (¹³ / ₁₆)	IRB 1316	34	20.638 (¹³ / ₁₆)	25.400 (1)	25.78	24.9	24.9	0.6	BA 1616Z	BHA 1616Z	YB 1616 YBH 1616
22.225 (⁷ / ₈)	IRB 148	25	22.225 (⁷ / ₈)	28.575 (1 ¹ / ₂)	13.08	27	27.5	0.6	BA 188Z	—	YB 188
	IRB 1412	37.5	22.225 (⁷ / ₈)	28.575 (1 ¹ / ₂)	19.43	27	27.5	0.6	BA 1812Z	BHA 1812Z	YB 1812
	IRB 1416	50	22.225 (⁷ / ₈)	28.575 (1 ¹ / ₂)	25.78	27	27.5	0.6	BA 1816Z	BHA 1816Z	YB 1816
	IRB 1420	62.5	22.225 (⁷ / ₈)	28.575 (1 ¹ / ₂)	32.13	27	27.5	0.6	BA 1820Z	BHA 1820Z	—
25.400 (1)	IRB 168	28.5	25.400 (1)	31.750 (1 ¹ / ₂)	13.08	30	30.7	0.6	BA 208Z	—	—
	IRB 1610	35.5	25.400 (1)	31.750 (1 ¹ / ₂)	16.25	30	30.7	0.6	BA 2010Z	—	YB 2010
	IRB 1612	42.5	25.400 (1)	31.750 (1 ¹ / ₂)	19.43	30	30.7	0.6	BA 2012Z	—	YB 2012
	IRB 1616	56	25.400 (1)	31.750 (1 ¹ / ₂)	25.78	30	30.7	0.6	BA 2016Z	BHA 2016Z	YB 2016
	IRB 1620	70	25.400 (1)	31.750 (1 ¹ / ₂)	32.13	30	30.7	0.6	BA 2020Z	—	—
	IRB 168-1	36.5	25.400 (1)	33.338 (1 ¹ / ₂)	13.08	30	32.1	0.6	BA 218Z	—	—
	IRB 1610-1	45.5	25.400 (1)	33.338 (1 ¹ / ₂)	16.25	30	32.1	0.6	BA 2110Z	—	—
	IRB 1612-1	54.5	25.400 (1)	33.338 (1 ¹ / ₂)	19.43	30	32.1	0.6	BA 2112Z	—	—

Note () Maximum allowable fillet corner radius of shaft
Remark No oil hole is provided.

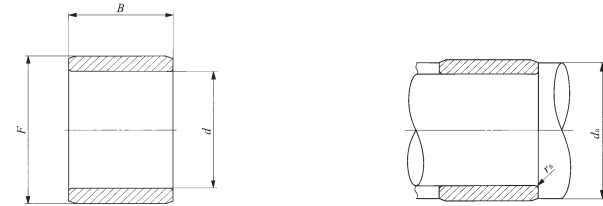

RB

Shaft dia. mm (inch)	Identification number	Mass (Ref.) g	Boundary dimensions mm(inch)			Standard mounting dimensions mm (^())			Assembled bearings		
			<i>d</i>	<i>F</i>	<i>B</i>	<i>d_a</i> Min.	<i>r_s</i> Max.	<i>r_s</i> Max.	BA...Z (BAM)	BHA...Z (BHAM)	YB YBH
28.575 (1 ¹ / ₈)	IRB 188	31.5	28.575 (1 ¹ / ₈)	34.925 (1 ³ / ₈)	13.08	33.2	33.9	0.6	BA 228Z	—	YB 228
	IRB 1812	47	28.575 (1 ¹ / ₈)	34.925 (1 ³ / ₈)	19.43	33.2	33.9	0.6	BA 2212Z	BHA 2212Z	YB 2212
	IRB 1816	62.5	28.575 (1 ¹ / ₈)	34.925 (1 ³ / ₈)	25.78	33.2	33.9	0.6	BA 2216Z	BHA 2216Z	—
	IRB 1820	78	28.575 (1 ¹ / ₈)	34.925 (1 ³ / ₈)	32.13	33.2	33.9	0.6	BA 2220Z	—	YB 2220
31.750 (1 ¹ / ₄)	IRB 2010	43	31.750 (1 ¹ / ₄)	38.100 (1 ¹ / ₂)	16.25	37	37.1	0.6	BA 2410Z	—	—
	IRB 2014	60	31.750 (1 ¹ / ₄)	38.100 (1 ¹ / ₂)	22.60	37	37.1	0.6	BA 2414Z	—	YB 2414
	IRB 2016	68.5	31.750 (1 ¹ / ₄)	38.100 (1 ¹ / ₂)	25.78	37	37.1	0.6	BA 2416Z	—	YB 2416
	IRB 2020	85.5	31.750 (1 ¹ / ₄)	38.100 (1 ¹ / ₂)	32.13	37	37.1	0.6	BA 2420Z	—	YB 2420
34.925 (1 ³ / ₈)	IRB 2210	47	34.925 (1 ³ / ₈)	41.275 (1 ⁵ / ₈)	16.25	40.2	40.2	0.6	BA 2610Z	—	YB 2610
	IRB 2220	93.5	34.925 (1 ³ / ₈)	41.275 (1 ⁵ / ₈)	32.13	40.2	40.2	0.6	BA 2620Z	—	—
36.512 (1 ⁷ / ₁₆)	IRB 2316	99	36.512 (1 ⁷ / ₁₆)	44.450 (1 ⁷ / ₁₆)	25.78	42.5	43.2	0.6	BA 2816Z	—	—
38.100 (1 ¹ / ₂)	IRB 2412	62	38.100 (1 ¹ / ₂)	44.450 (1 ⁷ / ₁₆)	19.43	43.3	43.4	0.6	BA 2812Z	—	—
	IRB 2416	81	38.100 (1 ¹ / ₂)	44.450 (1 ⁷ / ₁₆)	25.78	43.3	43.4	0.6	BA 2816Z	—	YB 2816
	IRB 2424	121	38.100 (1 ¹ / ₂)	44.450 (1 ⁷ / ₁₆)	38.48	43.3	43.4	0.6	BA 2824Z	BHA 2824Z	—
	IRB 248-1	64	38.100 (1 ¹ / ₂)	47.625 (1 ³ / ₈)	13.08	44.5	45.5	1	BA 308Z	—	—
IRB 2410-1	79.5	38.100 (1 ¹ / ₂)	47.625 (1 ³ / ₈)	16.25	44.5	45.5	1	BA 3010Z	—	—	
41.275 (1 ⁵ / ₈)	IRB 2616	136	41.275 (1 ⁵ / ₈)	50.800 (2)	25.78	47.5	48.5	1	BA 3216Z	—	—
	IRB 2628	235	41.275 (1 ⁵ / ₈)	50.800 (2)	44.83	47.5	48.5	1	BAW 3228Z	—	—
42.862 (1 ¹¹ / ₁₆)	IRB 2720	146	42.862 (1 ¹¹ / ₁₆)	50.800 (2)	32.13	48.5	49.5	0.6	BA 3220Z	—	—
	IRB 3016	100	47.625 (1 ³ / ₈)	53.975 (2 ¹ / ₈)	25.78	52.9	52.9	0.6	BA 3416Z	—	—
47.625 (1 ³ / ₈)	IRB 3024	149	47.625 (1 ³ / ₈)	53.975 (2 ¹ / ₈)	38.48	52.9	52.9	0.6	BA 3424Z	—	—
	IRB 3616	183	57.150 (2 ¹ / ₄)	66.675 (2 ⁵ / ₈)	25.78	63.5	64.5	1	BA 4216Z	—	—
63.500 (2 ¹ / ₂)	IRB 4016	131	63.500 (2 ¹ / ₂)	69.850 (2 ³ / ₄)	25.78	68.7	68.8	0.6	BA 4416Z	—	—
	IRB 4020	164	63.500 (2 ¹ / ₂)	69.850 (2 ³ / ₄)	32.13	68.7	68.8	0.6	BA 4420Z	—	—

Note () Maximum allowable fillet corner radius of shaft
Remark No oil hole is provided.

1N=0.102kgf=0.2248lbs.
1mm=0.03937inch

INNER RINGS

Inner Rings for General Usage



Shaft dia. 5 – 20mm

Shaft dia. mm	Identification number		Mass (Ref.) g	Boundary dimensions mm				Standard mounting dimension mm		Assembled bearings	
				<i>d</i>	<i>F</i>	<i>B</i>	<i>r</i> _{s min} ⁽¹⁾	Min.	Max.		
5	LRT 5710	—	1.4	5	7	10	0.15	6.2	6.7	RNA 495	
	LRT 5812	—	2.8	5	8	12	0.2	6.6	7.7	TAF 81512	
	LRT 5816	—	3.8	5	8	16	0.2	6.6	7.7	TAF 81516	
6	LRT 6810	—	1.7	6	8	10	0.15	7.2	7.7	RNA 496	
	LRT 6912	—	3.2	6	9	12	0.2	7.6	8.7	TAF 91612	
	LRT 6916	—	4.3	6	9	16	0.2	7.6	8.7	TAF 91616	
	LRT 61010	—	3.9	6	10	10	0.3	8	9.7	RNAF 101710	
7	LRT 7910	—	1.9	7	9	10	0.15	8.2	8.7	RNA 497	
	LRT 71012	—	3.6	7	10	12	0.2	8.6	9.7	TAF 101712	
	LRT 71012-1	—	3.6	7	10	12	0.3	9	9.7	RNAF 102012	
	LRT 71016	—	4.9	7	10	16	0.2	8.6	9.7	TAF 101716	NAX 1023
8	LRT 81011	—	2.4	8	10	11	0.2	9.6	9.9	RNA 498	
9	LRT 91211	—	3.1	9	12	11	0.3	11	11.5	RNA 499	
	LRT 91212	—	4.5	9	12	12	0.3	11	11.5	TAF 121912	RNAF 122212
	LRT 91216	—	6	9	12	16	0.3	11	11.5	TAF 121916	NAX 1223
10	LRT 101412	—	7	10	14	12	0.3	12	13	RNAF 142612	
	LRT 101413	—	7.5	10	14	13	0.3	12	13	RNA 4900	RNAF 142213
	—	LRTZ 101414	8.2	10	14	14	0.3	12	13	RNA 4900 UU	
	LRT 101416	—	9	10	14	16	0.3	12	13	TAF 142216	
LRT 101420	—	11.5	10	14	20	0.3	12	13	TAF 142220	RNAFW142220	
12	LRT 121516	—	8	12	15	16.5	0.3	14	14.5	NAX 1523	NBX 1523
	LRT 121612	—	8.5	12	16	12	0.3	14	15	RNAF 162812	
	LRT 121613	—	8.5	12	16	13	0.3	14	15	RNA 4901	RNAF 162413
	—	LRTZ 121614	9.6	12	16	14	0.3	14	15	RNA 4901 UU	
	LRT 121616	—	10.5	12	16	16	0.3	14	15	TAF 162416	
	LRT 121620	—	13.5	12	16	20	0.3	14	15	TAF 162420	RNAFW162420

Note⁽¹⁾ Minimum allowable value of chamfer dimension *r*
Remark No oil hole is provided.

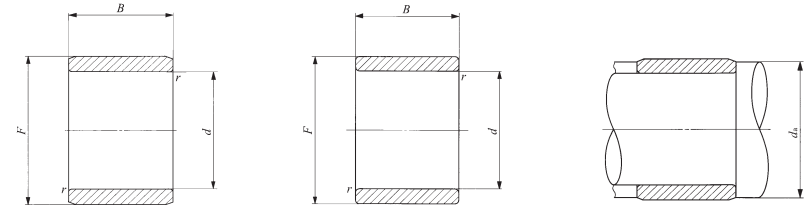

LRT

LRTZ

Shaft dia. mm	Identification number		Mass (Ref.) g	Boundary dimensions mm				Standard mounting dimension mm		Assembled bearings	
				<i>d</i>	<i>F</i>	<i>B</i>	<i>r</i> _{s min} ⁽¹⁾	Min.	Max.		
12	LRT 121622	—	14.5	12	16	22	0.3	14	15	RNA 6901	
	—	LRTZ 121623	15.5	12	16	23	0.3	14	15	RNA 6901 UU	
14	LRT 141717	—	9.5	14	17	17	0.3	16	16.5	NAX 1725	NBX 1725
15	LRT 151916	—	12.5	15	19	16	0.3	17	18	TAF 192716	
	LRT 151920	—	16	15	19	20	0.3	17	18	TAF 192720	
	LRT 152012	—	12	15	20	12	0.3	17	19	RNAF 203212	
	LRT 152013	—	13.5	15	20	13	0.3	17	19	RNA 4902	RNAF 202813
	—	LRTZ 152014	14.5	15	20	14	0.3	17	19	RNA 4902 UU	
	LRT 152020	—	21.5	15	20	20.5	0.3	17	19	TR 203320	
	—	LRTZ 152020	21.5	15	20	20.5	0.3	17	19	GTR 203320	
	LRT 152023	—	24	15	20	23	0.3	17	19	RNA 6902	
—	LRTZ 152024	25	15	20	24	0.3	17	19	RNA 6902 UU		
LRT 152026	—	28	15	20	26	0.3	17	19	RNAFW 202826		
17	LRT 172020	—	13.5	17	20	20.5	0.3	19	19.5	NAX 2030	NBX 2030
	LRT 172116	—	14.5	17	21	16	0.3	19	20	TAF 212916	
	LRT 172120	—	18	17	21	20	0.3	19	20	TAF 212920	
	LRT 172213	—	15.5	17	22	13	0.3	19	21	RNA 4903	RNAF 223013
	—	LRTZ 172214	16.5	17	22	14	0.3	19	21	RNA 4903 UU	
	LRT 172216	—	19	17	22	16	0.3	19	21	RNAF 223516	
	LRT 172223	—	26.5	17	22	23	0.3	19	21	RNA 6903	
	—	LRTZ 172224	28	17	22	24	0.3	19	21	RNA 6903 UU	
	LRT 172225	—	30	17	22	25.5	0.3	19	21	TR 223425	
	—	LRTZ 172225	30	17	22	25.5	0.3	19	21	GTR 223425	
LRT 172226	—	31	17	22	26	0.3	19	21	RNAFW 223026		
LRT 172232	—	38	17	22	32	0.3	19	21	RNAFW 223532		
20	LRT 202416	—	16.5	20	24	16	0.3	22	23	TAF 243216	
	LRT 202420	—	20.5	20	24	20	0.3	22	23	TAF 243220	

Note⁽¹⁾ Minimum allowable value of chamfer dimension *r*
Remark No oil hole is provided.

1N=0.102kgf=0.2248lbs.
1mm=0.03937inch



INNER RINGS

Inner Rings for General Usage



Shaft dia. 20 – 32mm

Shaft dia. mm	Identification number		Mass (Ref.) g	Boundary dimensions mm				Standard mounting dimension mm		Assembled bearings
				<i>d</i>	<i>F</i>	<i>B</i>	<i>r</i> _{s min} ⁽¹⁾	Min.	Max.	
20	LRT 202516	—	22	20	25	16	0.3	22	24	RNAF 253716
	LRT 202517	—	23	20	25	17	0.3	22	24	RNA 4904 RNAF 253517
	—	LRTZ 202518	24	20	25	18	0.3	22	24	RNA 4904 UU
	LRT 202520	—	28	20	25	20.5	0.3	22	24	TR 253820 NAX 2530 NBX 2530
	—	LRTZ 202520	28	20	25	20.5	0.3	22	24	GTR 253820
	LRT 202525	—	35	20	25	25.5	0.3	22	24	TR 253825
	—	LRTZ 202525	35	20	25	25.5	0.3	22	24	GTR 253825
	LRT 202526	—	36	20	25	26	0.3	22	24	RNAFW 253526
	LRT 202530	—	40.5	20	25	30	0.3	22	24	RNA 6904
	—	LRTZ 202531	41.5	20	25	31	0.3	22	24	RNA 6904 UU
LRT 202532	—	44	20	25	32	0.3	22	24	RNAFW 253732	
22	LRT 222616	—	17.5	22	26	16	0.3	24	25	TAF 263416
	LRT 222620	—	24	22	26	20	0.3	24	25	TAF 263420
	LRT 222817	—	30.5	22	28	17	0.3	24	27	RNA 49/22
	—	LRTZ 222818	32	22	28	18	0.3	24	27	RNA 49/22 UU
	LRT 222830	—	55	22	28	30	0.3	24	27	RNA 69/22
—	LRTZ 222831	55	22	28	31	0.3	24	27	RNA 69/22 UU	
25	LRT 252920	—	25	25	29	20	0.3	27	28	TAF 293820
	LRT 252930	—	38	25	29	30	0.3	27	28	TAF 293830
	LRT 253016	—	28	25	30	16	0.3	27	29	RNAF 304216
	LRT 253017	—	28.5	25	30	17	0.3	27	29	RNA 4905 RNAF 304017
	—	LRTZ 253018	29.5	25	30	18	0.3	27	29	RNA 4905 UU
	LRT 253020	—	34	25	30	20.5	0.3	27	29	NAX 3030 NBX 3030
	LRT 253025	—	42	25	30	25.5	0.3	27	29	TR 304425
	—	LRTZ 253025	42	25	30	25.5	0.3	27	29	GTR 304425
	LRT 253026	—	44.5	25	30	26	0.3	27	29	RNAFW 304026
	LRT 253030	—	49	25	30	30	0.3	27	29	RNA 6905

Note(1) Minimum allowable value of chamfer dimension *r*
Remark No oil hole is provided.

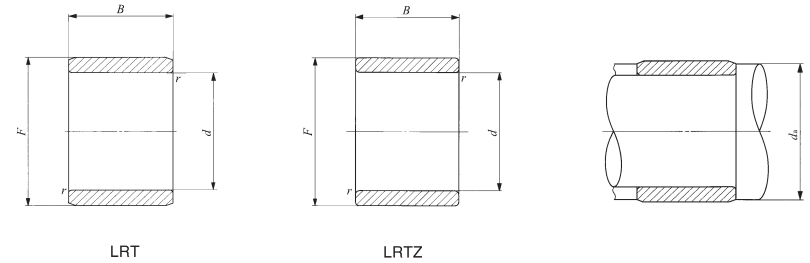

Shaft dia. mm	Identification number		Mass (Ref.) g	Boundary dimensions mm				Standard mounting dimension mm		Assembled bearings
				<i>d</i>	<i>F</i>	<i>B</i>	<i>r</i> _{s min} ⁽¹⁾	Min.	Max.	
25	—	LRTZ 253031	51	25	30	31	0.3	27	29	RNA 6905 UU
	LRT 253032	—	54	25	30	32	0.3	27	29	RNAFW 304232
28	LRT 283217	—	24.5	28	32	17	0.3	30	31	RNA 49/28
	—	LRTZ 283218	25.5	28	32	18	0.3	30	31	RNA 49/28 UU
	LRT 283220	—	28.5	28	32	20	0.3	30	31	TAF 324220
	LRT 283230	—	43	28	32	30	0.3	30	31	RNA 69/28 TAF 324230
	—	LRTZ 283230	43	28	32	30.5	0.3	30	31	GTR 324530
—	LRTZ 283231	44	28	32	31	0.3	30	31	RNA 69/28 UU	
30	LRT 303516	—	31.5	30	35	16	0.3	32	34	RNAF 354716
	LRT 303517	—	33.5	30	35	17	0.3	32	34	RNA 4906 RNAF 354517
	—	LRTZ 303518	35	30	35	18	0.3	32	34	RNA 4906 UU
	LRT 303520	—	38.5	30	35	20	0.3	32	34	TAF 354520 NAX 3530 NBX 3530
	LRT 303526	—	52	30	35	26	0.3	32	34	RNAFW 354526
	LRT 303530	—	59	30	35	30	0.3	32	34	RNA 6906 TAF 354530
	LRT 303530-1	—	59	30	35	30.5	0.3	32	34	TR 354830
	—	LRTZ 303530	59	30	35	30.5	0.3	32	34	GTR 354830
	—	LRTZ 303531	61	30	35	31	0.3	32	34	RNA 6906 UU
	LRT 303532	—	64	30	35	32	0.3	32	34	RNAFW 354732
32	LRT 323720	—	43.5	32	37	20	0.3	34	36	TAF 374720
	LRT 323730	—	63	32	37	30	0.3	34	36	TAF 374730
	LRT 323830	—	77	32	38	30.5	0.6	36	37	TR 385230
	—	LRTZ 323830	77	32	38	30.5	0.6	36	37	GTR 385230
	LRT 324020	—	69	32	40	20	0.6	36	39	RNA 49/32
	—	LRTZ 324021	72.5	32	40	21	0.6	36	39	RNA 49/32 UU
	LRT 324036	—	123	32	40	36	0.6	36	39	RNA 69/32
—	LRTZ 324037	130	32	40	37	0.6	36	39	RNA 69/32 UU	

Note(1) Minimum allowable value of chamfer dimension *r*
Remark No oil hole is provided.

1N=0.102kgf=0.2248lbs.
1mm=0.03937inch

H

IRT
IRB
LRT
LRB

INNER RINGS

Inner Rings for General Usage



Shaft dia. 35 – 50mm

Shaft dia. mm	Identification number		Mass (Ref.) g	Boundary dimensions mm				Standard mounting dimension mm		Assembled bearings	
				d	F	B	$r_{s \text{ min}}^{(1)}$	Min.	Max.		
35	LRT 354017	—	39	35	40	17	0.3	37	39	RNAF 405017	
	LRT 354020	—	46	35	40	20	0.3	37	39	TAF 405020 RNAF 405520 NAX 4032 NBX 4032	
	—	LRTZ 354020	46	35	40	20.5	0.6	39	39.5	GTR 405520	
	LRT 354030	—	67	35	40	30	0.3	37	39	TAF 405030	
	LRT 354034	—	78	35	40	34	0.3	37	39	RNAFW 405034	
	LRT 354040	—	95	35	40	40	0.3	37	39	RNAFW 405540	
	LRT 354220	—	65	35	42	20	0.6	39	41	RNA 4907	
	—	LRTZ 354221	67	35	42	21	0.6	39	41	RNA 4907 UU	
	LRT 354230	—	97	35	42	30.5	0.6	39	41	TR 425630	
	—	LRTZ 354230	100	35	42	30.5	0.6	39	41	GTR 425630	
38	LRT 354236	—	120	35	42	36	0.6	39	41	RNA 6907	
	—	LRTZ 354237	120	35	42	37	0.6	39	41	RNA 6907 UU	
	LRT 384320	—	47.5	38	43	20	0.3	40	42	TAF 435320	
LRT 384330	—	72	38	43	30	0.3	40	42	TAF 435330		
40	LRT 404517	—	44.5	40	45	17	0.3	42	44	RNAF 455517	
	LRT 404520	—	51	40	45	20	0.3	42	44	TAF 455520 RNAF 456220 NAX 4532 NBX 4532	
	LRT 404530	—	77	40	45	30	0.3	42	44	TAF 455530	
	LRT 404530-1	—	77	40	45	30.5	0.6	44	44.5	TR 455930	
	—	LRTZ 404530	77	40	45	30.5	0.6	44	44.5	GTR 455930	
	LRT 404534	—	88	40	45	34	0.3	42	44	RNAFW 455534	
	LRT 404540	—	105	40	45	40	0.3	42	44	RNAFW 456240	
	LRT 404822	—	93	40	48	22	0.6	44	47	RNA 4908	
	—	LRTZ 404823	95	40	48	23	0.6	44	47	RNA 4908 UU	
	LRT 404840	—	165	40	48	40	0.6	44	47	RNA 6908	
—	LRTZ 404841	170	40	48	41	0.6	44	47	RNA 6908 UU		

Note⁽¹⁾ Minimum allowable value of chamfer dimension r
Remark No oil hole is provided.

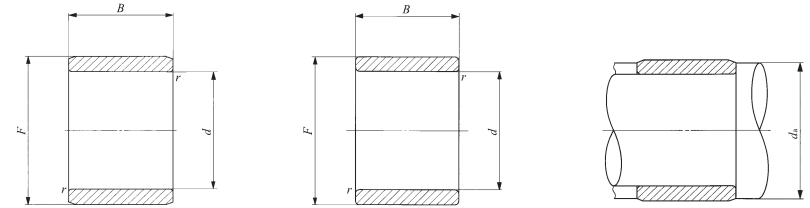

LRT

LRTZ

Shaft dia. mm	Identification number		Mass (Ref.) g	Boundary dimensions mm				Standard mounting dimension mm		Assembled bearings	
				d	F	B	$r_{s \text{ min}}^{(1)}$	Min.	Max.		
42	LRT 424720	—	54	42	47	20	0.3	44	46	TAF 475720	
	LRT 424730	—	81	42	47	30	0.3	44	46	TAF 475730	
	LRT 424830	—	100	42	48	30.5	0.6	46	47	TR 486230	
	—	LRTZ 424830	100	42	48	30.5	0.6	46	47	GTR 486230	
45	LRT 455020	—	58	45	50	20	0.3	47	49	RNAF 506220	
	LRT 455025	—	71	45	50	25	0.3	47	49	TAF 506225 NAX 5035 NBX 5035	
	LRT 455030	—	90	45	50	30.5	0.6	49	49.5	TR 506430	
	—	LRTZ 455030	90	45	50	30.5	0.6	49	49.5	GTR 506430	
	LRT 455035	—	95	45	50	35	0.3	47	49	TAF 506235	
	LRT 455040	—	115	45	50	40	0.3	47	49	RNAFW 506240	
	LRT 455222	—	88	45	52	22	0.6	49	51	RNA 4909	
	—	LRTZ 455223	93	45	52	23	0.6	49	51	RNA 4909 UU	
	LRT 455240	—	165	45	52	40	0.6	49	51	RNA 6909	
	—	LRTZ 455241	170	45	52	41	0.6	49	51	RNA 6909 UU	
50	LRT 455520	—	120	45	55	20	1	50	54	RNAF 557220	
	LRT 455540	—	245	45	55	40	1	50	54	RNAFW 557240	
	LRT 505520	—	63	50	55	20	0.3	52	54	RNAF 556820	
	LRT 505525	—	77	50	55	25	0.3	52	54	TAF 556825	
	LRT 505535	—	110	50	55	35	0.3	52	54	TAF 556835	
	LRT 505540	—	130	50	55	40	0.3	52	54	RNAFW 556840	
	LRT 505822	—	116	50	58	22	0.6	54	57	RNA 4910	
	—	LRTZ 505823	118	50	58	23	0.6	54	57	RNA 4910 UU	
	LRT 505840	—	210	50	58	40	0.6	54	57	RNA 6910	
	—	LRTZ 505841	215	50	58	41	0.6	54	57	RNA 6910 UU	
LRT 505845	—	235	50	58	45.5	1	55	57	TR 587745		
—	LRTZ 505845	235	50	58	45.5	1	55	57	GTR 587745		
LRT 506020	—	135	50	60	20	1	55	59	RNAF 607820		

Note⁽¹⁾ Minimum allowable value of chamfer dimension r
Remark No oil hole is provided.

1N=0.102kgf=0.2248lbs.
1mm=0.03937inch

INNER RINGS

Inner Rings for General Usage



Shaft dia. 50 – 80mm

Shaft dia. mm	Identification number		Mass (Ref.) g	Boundary dimensions mm				Standard mounting dimension mm		Assembled bearings	
				<i>d</i>	<i>F</i>	<i>B</i>	<i>r_s</i> min ⁽¹⁾	Min.	Max.		
50	LRT 506025	—	165	50	60	25.5	1	55	59	NAX 6040	NBX 6040
	LRT 506040	—	265	50	60	40	1	55	59	RNAFW 607840	
55	LRT 556025	—	88	55	60	25	0.3	57	59	TAF 607225	
	LRT 556035	—	120	55	60	35	0.3	57	59	TAF 607235	
	LRT 556238	—	190	55	62	38.5	1	60	60.5	TR 628138	
	—	LRTZ 556238	190	55	62	38.5	1	60	60.5	GTR 628138	
	LRT 556325	—	145	55	63	25	1	60	61	RNA 4911	
	—	LRTZ 556326	150	55	63	26	1	60	61	RNA 4911 UU	
	LRT 556345	—	255	55	63	45	1	60	61	RNA 6911	
	—	LRTZ 556346	260	55	63	46	1	60	61	RNA 6911 UU	
55	LRT 556530	—	220	55	65	30	1.5	63	63.5	RNAF 658530	
	LRT 556560	—	435	55	65	60	1.5	63	63.5	RNAFW 658560	
60	LRT 606825	—	150	60	68	25	0.6	64	66	TAF 688225	
	LRT 606825-1	—	150	60	68	25	1	65	66	RNA 4912	
	—	LRTZ 606826	160	60	68	26	1	65	66	RNA 4912 UU	
	LRT 606835	—	210	60	68	35	0.6	64	66	TAF 688235	
	LRT 606845	—	275	60	68	45	1	65	66	RNA 6912	
	—	LRTZ 606846	280	60	68	46	1	65	66	RNA 6912 UU	
	LRT 607025	—	195	60	70	25.5	1	65	68	NAX 7040	
	LRT 607030	—	240	60	70	30	1.5	68	68.5	RNAF 709030	
	LRT 607045	—	355	60	70	45.5	1	65	68	TR 708945	
	—	LRTZ 607045	360	60	70	45.5	1	65	68	GTR 708945	
60	LRT 607060	—	480	60	70	60	1.5	68	68.5	RNAFW 709060	
	LRT 657225	—	145	65	72	25	1	70	70.5	RNA 4913	
65	—	LRTZ 657226	150	65	72	26	1	70	70.5	RNA 4913 UU	
	LRT 657245	—	255	65	72	45	1	70	70.5	RNA 6913	
	—	LRTZ 657246	265	65	72	46	1	70	70.5	RNA 6913 UU	
	LRT 657335	—	235	65	73	35	1	70	71	TAF 739035	

Note⁽¹⁾ Minimum allowable value of chamfer dimension *r*
Remark No oil hole is provided.

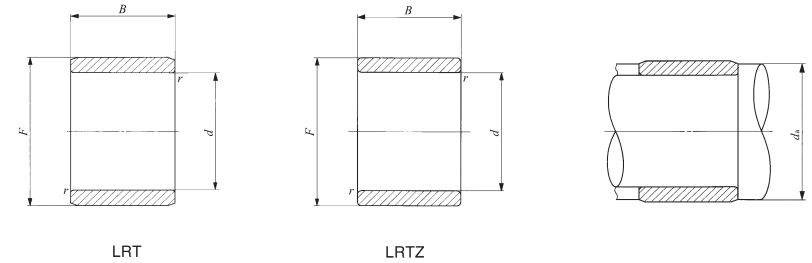

Shaft dia. mm	Identification number		Mass (Ref.) g	Boundary dimensions mm				Standard mounting dimension mm		Assembled bearings	
				<i>d</i>	<i>F</i>	<i>B</i>	<i>r_s</i> min ⁽¹⁾	Min.	Max.		
65	LRT 657530	—	260	65	75	30	1.5	73	73.5	RNAF 759530	
	LRT 657560	—	520	65	75	60	1.5	73	73.5	RNAFW 759560	
70	LRT 708025	—	225	70	80	25	1	75	78	TAF 809525	
	LRT 708030	—	275	70	80	30	1	75	78	RNA 4914	
	LRT 708030-1	—	275	70	80	30	1.5	78	78.5	RNAF 8010030	
	—	LRTZ 708031	275	70	80	31	1	75	78	RNA 4914 UU	
	LRT 708035	—	310	70	80	35	1	75	78	TAF 809535	
	LRT 708054	—	490	70	80	54	1	75	78	RNA 6914	
	—	LRTZ 708055	500	70	80	55	1	75	78	RNA 6914 UU	
70	LRT 708060	—	560	70	80	60	1.5	78	78.5	RNAFW 8010060	
	LRT 758345	—	350	75	83	45.5	1	80	81	TR 8310845	
75	—	LRTZ 758345	350	75	83	45.5	1	80	81	GTR 8310845	
	LRT 758525	—	240	75	85	25	1	80	83	TAF 8510525	
	LRT 758530	—	290	75	85	30	1	80	83	RNA 4915	
	LRT 758530-1	—	290	75	85	30	1.5	83	83.5	RNAF 8510530	
	—	LRTZ 758531	300	75	85	31	1	80	83	RNA 4915 UU	
	LRT 758535	—	335	75	85	35	1	80	83	TAF 8510535	
	LRT 758554	—	520	75	85	54	1	80	83	RNA 6915	
	—	LRTZ 758555	530	75	85	55	1	80	83	RNA 6915 UU	
80	LRT 809025	—	255	80	90	25	1	85	88	TAF 9011025	
	LRT 809030	—	310	80	90	30	1	85	88	RNA 4916	
	LRT 809030-1	—	310	80	90	30	1.5	88	88.5	RNAF 9011030	
	—	LRTZ 809031	315	80	90	31	1	85	88	RNA 4916 UU	
	LRT 809035	—	355	80	90	35	1	85	88	TAF 9011035	
	LRT 809054	—	550	80	90	54	1	85	88	RNA 6916	
80	—	LRTZ 809055	560	80	90	55	1	85	88	RNA 6916 UU	

Note⁽¹⁾ Minimum allowable value of chamfer dimension *r*
Remark No oil hole is provided.

1N=0.102kgf=0.2248lbs.
1mm=0.03937inch

INNER RINGS

Inner Rings for General Usage



Shaft dia. 85 – 140mm

Shaft dia. mm	Identification number		Mass (Ref.) g	Boundary dimensions mm				Standard mounting dimension mm		Assembled bearings
				<i>d</i>	<i>F</i>	<i>B</i>	$r_{s \text{ min}}^{(1)}$	Min.	Max.	
85	LRT 859350	—	440	85	93	50.5	1	90	91	TR 9311850
	—	LRTZ 859350	440	85	93	50.5	1	90	91	GTR 9311850
	LRT 859526	—	280	85	95	26	1	90	93	TAF 9511526
	LRT 859530	—	330	85	95	30	1.5	93	93.5	RNAF 9511530
	LRT 859536	—	390	85	95	36	1	90	93	TAF 9511536
	LRT 859545	—	490	85	95	45.5	1.5	93	93.5	TR 9512045
	—	LRTZ 859545	490	85	95	45.5	1.5	93	93.5	GTR 9512045
	LRT 8510035	—	575	85	100	35	1.1	91.5	98	RNA 4917
	—	LRTZ 8510036	605	85	100	36	1.1	91.5	98	RNA 4917 UU
	LRT 8510063	—	1 040	85	100	63	1.1	91.5	98	RNA 6917
—	LRTZ 8510064	1 060	85	100	64	1.1	91.5	98	RNA 6917 UU	
90	LRT 9010026	—	295	90	100	26	1	95	98	TAF 10012026
	LRT 9010030	—	355	90	100	30	1.5	98	98.5	RNAF 10012030
	LRT 9010036	—	415	90	100	36	1	95	98	TAF 10012036
	LRT 9010050	—	580	90	100	50.5	1.5	98	98.5	TR 10012550
	—	LRTZ 9010050	580	90	100	50.5	1.5	98	98.5	GTR 10012550
	LRT 9010535	—	610	90	105	35	1.1	96.5	103	RNA 4918
	—	LRTZ 9010536	630	90	105	36	1.1	96.5	103	RNA 4918 UU
	LRT 9010563	—	1 100	90	105	63	1.1	96.5	103	RNA 6918
—	LRTZ 9010564	1 120	90	105	64	1.1	96.5	103	RNA 6918 UU	
95	LRT 9510526	—	315	95	105	26	1	100	103	TAF 10512526
	LRT 9510536	—	430	95	105	36	1	100	103	TAF 10512536
	LRT 9511035	—	650	95	110	35	1.1	101.5	108	RNA 4919
	—	LRTZ 9511036	660	95	110	36	1.1	101.5	108	RNA 4919 UU
	LRT 9511063	—	1 160	95	110	63	1.1	101.5	108	RNA 6919
—	LRTZ 9511064	1 180	95	110	64	1.1	101.5	108	RNA 6919 UU	

Note⁽¹⁾ Minimum allowable value of chamfer dimension *r*
 Remark No oil hole is provided.

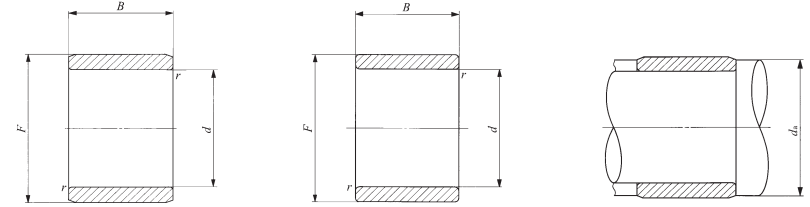

LRT

LRTZ

Shaft dia. mm	Identification number		Mass (Ref.) g	Boundary dimensions mm				Standard mounting dimension mm		Assembled bearings
				<i>d</i>	<i>F</i>	<i>B</i>	$r_{s \text{ min}}^{(1)}$	Min.	Max.	
100	LRT 10011030	—	380	100	110	30	1	105	108	TAF 11013030
	LRT 10011040	—	500	100	110	40	1	105	108	TAF 11013040
	LRT 10011050	—	640	100	110	50.5	1.5	108	108.5	TR 11013550
	—	LRTZ 10011050	640	100	110	50.5	1.5	108	108.5	GTR 11013550
	LRT 10011540	—	770	100	115	40	1.1	106.5	113	RNA 4920
	—	LRTZ 10011541	780	100	115	41	1.1	106.5	113	RNA 4920 UU
105	LRT 10511550	—	670	105	115	50.5	1.5	113	113.5	TR 11515350
	—	LRTZ 10511550	670	105	115	50.5	1.5	113	113.5	GTR 11515350
110	LRT 11012030	—	410	110	120	30	1	115	118	RNA 4822
	LRT 11012540	—	840	110	125	40	1.1	116.5	123	RNA 4922
	—	LRTZ 11012541	870	110	125	41	1.1	116.5	123	RNA 4922 UU
120	LRT 12013030	—	450	120	130	30	1	125	128	RNA 4824
	LRT 12013545	—	1 030	120	135	45	1.1	126.5	133	RNA 4924
	—	LRTZ 12013546	1 050	120	135	46	1.1	126.5	133	RNA 4924 UU
125	LRT 12514060	—	1 460	125	140	60.5	1.5	133	138	TR 14017860
	—	LRTZ 12514060	1 460	125	140	60.5	1.5	133	138	GTR 14017860
130	LRT 13014535	—	860	130	145	35	1.1	136.5	143	RNA 4826
	LRT 13015050	—	1 670	130	150	50	1.5	138	148	RNA 4926
	—	LRTZ 13015051	1 720	130	150	51	1.5	138	148	RNA 4926 UU
135	LRT 13515060	—	1 560	135	150	60.5	1.5	143	148	TR 15018860
	—	LRTZ 13515060	1 560	135	150	60.5	1.5	143	148	GTR 15018860
140	LRT 14015535	—	930	140	155	35	1.1	146.5	153	RNA 4828
	LRT 14016050	—	1 790	140	160	50	1.5	148	158	RNA 4928
	—	LRTZ 14016051	1 830	140	160	51	1.5	148	158	RNA 4928 UU

Note⁽¹⁾ Minimum allowable value of chamfer dimension *r*
 Remark No oil hole is provided.

1N=0.102kgf=0.2248lbs.
 1mm=0.03937inch



INNER RINGS

Inner Rings for General Usage



Shaft dia. 150 – 440mm

Shaft dia. mm	Identification number		Mass (Ref.) g	Boundary dimensions mm				Standard mounting dimension mm		Assembled bearings	
				d	F	B	$r_s^{(1)}$	Min.	Max.		
150	LRT 15016540	—	1 130	150	165	40	1.1	156.5	163	RNA 4830	
	LRT 15017060	—	2 290	150	170	60	2	159	168	RNA 4930	
160	LRT 16017540	—	1 200	160	175	40	1.1	166.5	173	RNA 4832	
	LRT 16018060	—	2 440	160	180	60	2	169	178	RNA 4932	
170	LRT 17018545	—	1 420	170	185	45	1.1	176.5	183	RNA 4834	
	LRT 17019060	—	2 580	170	190	60	2	179	188	RNA 4934	
180	LRT 18019545	—	1 500	180	195	45	1.1	186.5	193	RNA 4836	
	LRT 18020569	—	3 950	180	205	69	2	189	203	RNA 4936	
190	LRT 19021050	—	2 380	190	210	50	1.5	198	208	RNA 4838	
	LRT 19021569	—	4 200	190	215	69	2	199	213	RNA 4938	
200	LRT 20022050	—	2 520	200	220	50	1.5	208	218	RNA 4840	
	LRT 20022580	—	5 000	200	225	80	2.1	211	223	RNA 4940	
220	LRT 22024050	—	2 750	220	240	50	1.5	228	238	RNA 4844	
	LRT 22024580	—	5 500	220	245	80	2.1	231	243	RNA 4944	
240	LRT 24026560	—	4 530	240	265	60	2	249	262	RNA 4848	
	LRT 24026580	—	6 000	240	265	80	2.1	251	262	RNA 4948	
260	LRT 26028560	—	4 930	260	285	60	2	269	282	RNA 4852	
	LRT 260290100	—	9 900	260	290	100	2.1	271	287	RNA 4952	
280	LRT 28030569	—	6 050	280	305	69	2	289	302	RNA 4856	
	LRT 280310100	—	10 600	280	310	100	2.1	291	307	RNA 4956	
300	LRT 30033080	—	9 100	300	330	80	2.1	311	327	RNA 4860	
	LRT 300340118	—	18 000	300	340	118	3	313	337	RNA 4960	
320	LRT 32035080	—	9 600	320	350	80	2.1	331	347	RNA 4864	
	LRT 320360118	—	19 200	320	360	118	3	333	357	RNA 4964	

Note⁽¹⁾ Minimum allowable value of chamfer dimension r
 Remark No oil hole is provided.

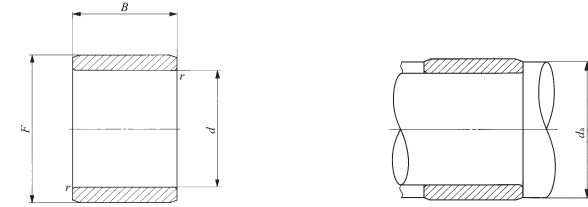

LRT

Shaft dia. mm	Identification number		Mass (Ref.) g	Boundary dimensions mm				Standard mounting dimension mm		Assembled bearings	
				d	F	B	$r_s^{(1)}$	Min.	Max.		
340	LRT 34037080	—	10 200	340	370	80	2.1	351	367	RNA 4868	
	LRT 340380118	—	20 300	340	380	118	3	353	377	RNA 4968	
360	LRT 36039080	—	10 800	360	390	80	2.1	371	387	RNA 4872	
	LRT 360400118	—	21 500	360	400	118	3	373	397	RNA 4972	
380	LRT 380415100	—	16 700	380	415	100	2.1	391	412	RNA 4876	
	LRT 380430140	—	33 900	380	430	140	4	396	427	RNA 4976	
400	LRT 400450140	—	35 600	400	450	140	4	416	447	RNA 4980	
420	LRT 420470140	—	37 300	420	470	140	4	436	467	RNA 4984	
440	LRT 440490160	—	44 100	440	490	160	4	456	487	RNA 4988	

Note⁽¹⁾ Minimum allowable value of chamfer dimension r
 Remark No oil hole is provided.

1N=0.102kgf=0.2248lbs.
 1mm=0.03937inch

INNER RINGS

Inner Rings for General Usage **Inch Series**

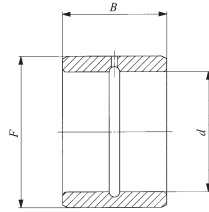

LRB

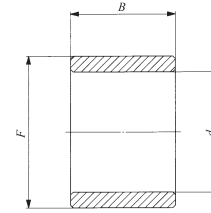

LRBZ

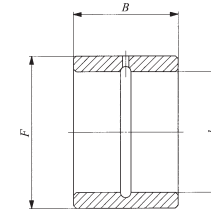

LRBZ...B

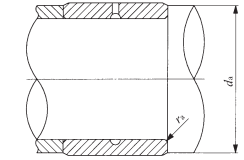

Shaft dia. 9.525 – 22.225mm

Shaft dia. mm (inch)	Identification number		Mass (Ref.) g	Boundary dimensions mm(inch)			Standard mounting dimensions mm (1)		
				<i>d</i>	<i>F</i>	<i>B</i>	<i>d_a</i> Min.	<i>d_a</i> Max.	<i>r_{as}</i> max Max.
9.525 (3/8)	LRB 61012	—	18.5	9.525 (3/8)	15.875 (5/8)	19.300	14	14.5	0.6
	—	LRBZ 61012	18.5	9.525 (3/8)	15.875 (5/8)	19.300	14	14.5	0.6
	—	LRBZ 61016	25	9.525 (3/8)	15.875 (5/8)	25.650	14	14.5	0.6
	—	LRBZ 61016 B	25	9.525 (3/8)	15.875 (5/8)	25.650	14	14.5	0.6
12.700 (1/2)	LRB 81212	—	23.5	12.70 (1/2)	19.5 (3/4)	19.300	17.5	18	1
	LRB 81216	—	31	12.70 (1/2)	19.5 (3/4)	25.650	17.5	18	1
	—	LRBZ 81212	23.5	12.70 (1/2)	19.5 (3/4)	19.300	17.5	18	0.6
	—	LRBZ 81216	31	12.70 (1/2)	19.5 (3/4)	25.650	17.5	18	0.6
—	LRBZ 81216 B	31	12.70 (1/2)	19.5 (3/4)	25.650	17.5	18	0.6	
15.875 (5/8)	LRB 101412	—	28	15.875 (5/8)	22.225 (7/8)	19.300	21	21.2	1
	LRB 101416	—	37.5	15.875 (5/8)	22.225 (7/8)	25.650	21	21.2	1
	—	LRBZ 101412	28	15.875 (5/8)	22.225 (7/8)	19.300	21	21.2	0.6
	—	LRBZ 101416	37.5	15.875 (5/8)	22.225 (7/8)	25.650	21	21.2	0.6
—	LRBZ 101416 B	37.5	15.875 (5/8)	22.225 (7/8)	25.650	21	21.2	0.6	
19.050 (3/4)	LRB 121612	—	33	19.050 (3/4)	25.40 (1)	19.300	24	24.4	1
	LRB 121616	—	44	19.050 (3/4)	25.40 (1)	25.650	24	24.4	1
	—	LRBZ 121612	33	19.050 (3/4)	25.40 (1)	19.300	24	24.4	0.6
	—	LRBZ 121616	44	19.050 (3/4)	25.40 (1)	25.650	24	24.4	0.6
—	LRBZ 121616 B	44	19.050 (3/4)	25.40 (1)	25.650	24	24.4	0.6	
22.225 (7/8)	LRB 141816	—	5	22.225 (7/8)	28.575 (1 1/8)	25.650	27	27.5	1
	LRB 141820	—	62	22.225 (7/8)	28.575 (1 1/8)	32.000	27	27.5	1
	—	LRBZ 141816	5	22.225 (7/8)	28.575 (1 1/8)	25.650	27	27.5	0.6
	—	LRBZ 141820	62	22.225 (7/8)	28.575 (1 1/8)	32.000	27	27.5	0.6
—	LRBZ 141820 B	62	22.225 (7/8)	28.575 (1 1/8)	32.000	27	27.5	0.6	

Note(1) Maximum allowable fillet corner radius of shaft

Remark LRBZ has no oil hole. LRB and LRBZ...B are provided with an oil groove and an oil hole.

Assembled bearings	
BR 101812	GBR 101812
GBR 101812	GBR 101816UU
BR 101816UU	
BR 122012	BR 122016
GBR 122012	GBR 122016UU
BR 122016UU	
BR 142212	BR 142216
GBR 142212	GBR 142216
GBR 142216	GBR 142216UU
BR 142216UU	
BR 162412	BR 162416
GBR 162412	GBR 162416
GBR 162416	GBR 162416UU
BR 162416UU	
BR 182616	BR 182620
GBR 182616	GBR 182620UU
BR 182620UU	

1N=0.102kgf=0.2248lbs.
1mm=0.03937inch

INNER RINGS

Inner Rings for General Usage **Inch Series**

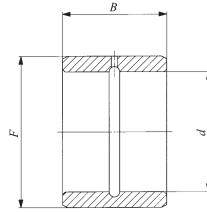

LRB

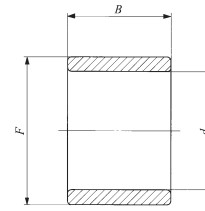

LRBZ

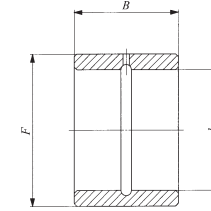

LRBZ...B

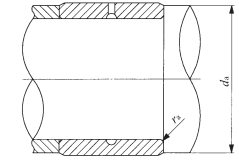

Shaft dia. 25.400 – 38.100mm

Shaft dia. mm (inch)	Identification number		Mass (Ref.) g	Boundary dimensions mm(inch)			Standard mounting dimensions mm		
				<i>d</i>	<i>F</i>	<i>B</i>	<i>d_a</i>		<i>r_{as max}</i> ⁽¹⁾
						Min.	Max.	Max.	
25.400 (1)	LRB 162016	—	56	25.400 (1)	31.750 (1 1/4)	25.650	30.5	30.7	1
	LRB 162020	—	72	25.400 (1)	31.750 (1 1/4)	32.000	30.5	30.7	1
	—	LRBZ 162016	56	25.400 (1)	31.750 (1 1/4)	25.650	30.5	30.7	0.6
	—	LRBZ 162020	72	25.400 (1)	31.750 (1 1/4)	32.000	30.5	30.7	0.6
	—	LRBZ 162020 B	72	25.400 (1)	31.750 (1 1/4)	32.000	30.5	30.7	0.6
28.575 (1 1/8)	LRB 182216	—	63	28.575 (1 1/8)	34.925 (1 3/8)	25.650	33.5	33.9	1
	LRB 182220	—	77	28.575 (1 1/8)	34.925 (1 3/8)	32.000	33.5	33.9	1
	—	LRBZ 182216	63	28.575 (1 1/8)	34.925 (1 3/8)	25.650	33.5	33.9	0.6
	—	LRBZ 182220	77	28.575 (1 1/8)	34.925 (1 3/8)	32.000	33.5	33.9	0.6
	—	LRBZ 182220 B	77	28.575 (1 1/8)	34.925 (1 3/8)	32.000	33.5	33.9	0.6
31.750 (1 1/4)	LRB 202416	—	71	31.750 (1 1/4)	38.100 (1 1/2)	25.650	37	37.1	1.5
	LRB 202420	—	86	31.750 (1 1/4)	38.100 (1 1/2)	32.000	37	37.1	1.5
	—	LRBZ 202416	71	31.750 (1 1/4)	38.100 (1 1/2)	25.650	37	37.1	0.6
	—	LRBZ 202420	86	31.750 (1 1/4)	38.100 (1 1/2)	32.000	37	37.1	0.6
	—	LRBZ 202420 B	86	31.750 (1 1/4)	38.100 (1 1/2)	32.000	37	37.1	0.6
34.925 (1 3/8)	LRB 222616	—	77	34.925 (1 3/8)	41.275 (1 5/8)	25.650	40.2	40.2	1.5
	LRB 222620	—	96	34.925 (1 3/8)	41.275 (1 5/8)	32.000	40.2	40.2	1.5
	—	LRBZ 222616	77	34.925 (1 3/8)	41.275 (1 5/8)	25.650	40.2	40.2	0.6
	—	LRBZ 222620	96	34.925 (1 3/8)	41.275 (1 5/8)	32.000	40.2	40.2	0.6
	—	LRBZ 222620 B	96	34.925 (1 3/8)	41.275 (1 5/8)	32.000	40.2	40.2	0.6
38.100 (1 1/2)	LRB 242816	—	80	38.100 (1 1/2)	44.450 (1 7/8)	25.650	43.3	43.4	1.5
	LRB 242820	—	100	38.100 (1 1/2)	44.450 (1 7/8)	32.000	43.3	43.4	1.5
	LRB 243020	—	155	38.100 (1 1/2)	47.625 (1 7/8)	32.000	43.3	45	1.5
	—	LRBZ 242820	100	38.100 (1 1/2)	44.450 (1 7/8)	32.000	43.3	43.4	0.6
	—	LRBZ 242820 B	100	38.100 (1 1/2)	44.450 (1 7/8)	32.000	43.3	43.4	0.6
	—	LRBZ 243020	160	38.100 (1 1/2)	47.625 (1 7/8)	32.000	43.3	45	1
	—	LRBZ 243020 B	160	38.100 (1 1/2)	47.625 (1 7/8)	32.000	43.3	45	1

Note⁽¹⁾ Maximum allowable fillet corner radius of shaft

Remark LRBZ has no oil hole. LRB and LRBZ...B are provided with an oil groove and an oil hole.

Assembled bearings

BR 202816
BR 202820
GBR 202816
GBR 202820UU
BR 202820UU

BR 223016
BR 223020
GBR 223016
GBR 223020UU
BR 223020UU

BR 243316
BR 243320
GBR 243316
GBR 243320 GBR 243320UU
BR 243320UU

BR 263516
BR 263520
GBR 263516
GBR 263520 GBR 263520UU
BR 263520UU

BR 283716
BR 283720 BR 283820
BR 303920
GBR 283720 GBR 283820 GBR 283720UU
BR 283720UU
GBR 303920 GBR 303920UU
BR 303920UU

1N=0.102kgf=0.2248lbs.
1mm=0.03937inch

INNER RINGS

Inner Rings for General Usage **Inch Series**

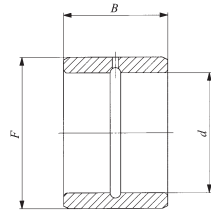

LRB

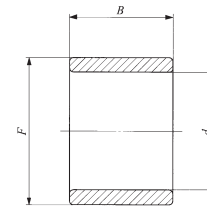

LRBZ

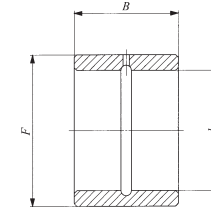

LRBZ...B

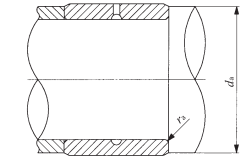

Shaft dia. 41.275 – 63.500mm

Shaft dia. mm (inch)	Identification number		Mass (Ref.) g	Boundary dimensions mm(inch)			Standard mounting dimensions mm ⁽¹⁾		
				<i>d</i>	<i>F</i>	<i>B</i>	<i>d_a</i>		<i>r_{as} max</i>
						Min.	Max.	Max.	
41.275 (1 5/8)	LRB 263216	—	135	41.275 (1 5/8)	50.800 (2)	25.650	48	49	1.5
	LRB 263220	—	170	41.275 (1 5/8)	50.800 (2)	32.000	48	49	1.5
	—	LRBZ 263216	135	41.275 (1 5/8)	50.800 (2)	25.650	48	49	1
	—	LRBZ 263220	170	41.275 (1 5/8)	50.800 (2)	32.000	48	49	1
	—	LRBZ 263220 B	170	41.275 (1 5/8)	50.800 (2)	32.000	48	49	1
44.450 (1 3/4)	LRB 283624	—	300	44.450 (1 3/4)	57.150 (2 1/4)	38.350	52.5	55	1.5
	LRB 283628	—	345	44.450 (1 3/4)	57.150 (2 1/4)	44.700	52.5	55	1.5
	—	LRBZ 283624	300	44.450 (1 3/4)	57.150 (2 1/4)	38.350	52.5	55	1.5
	—	LRBZ 283628	345	44.450 (1 3/4)	57.150 (2 1/4)	44.700	52.5	55	1.5
	—	LRBZ 283628 B	345	44.450 (1 3/4)	57.150 (2 1/4)	44.700	52.5	55	1.5
50.800 (2)	LRB 324024	—	335	50.800 (2)	63.500 (2 1/2)	38.350	58	61	2
	LRB 324028	—	390	50.800 (2)	63.500 (2 1/2)	44.700	58	61	2
	—	LRBZ 324024	335	50.800 (2)	63.500 (2 1/2)	38.350	58	61	1.5
	—	LRBZ 324028	390	50.800 (2)	63.500 (2 1/2)	44.700	58	61	1.5
	—	LRBZ 324028 B	390	50.800 (2)	63.500 (2 1/2)	44.700	58	61	1.5
57.150 (2 1/4)	LRB 364424	—	375	57.150 (2 1/4)	69.850 (2 3/4)	38.350	65	67	2
	LRB 364428	—	440	57.150 (2 1/4)	69.850 (2 3/4)	44.700	65	67	2
	—	LRBZ 364424	375	57.150 (2 1/4)	69.850 (2 3/4)	38.350	65	67	1.5
	—	LRBZ 364428	440	57.150 (2 1/4)	69.850 (2 3/4)	44.700	65	67	1.5
	—	LRBZ 364428 B	440	57.150 (2 1/4)	69.850 (2 3/4)	44.700	65	67	1.5
63.500 (2 1/2)	LRB 404824	—	410	63.500 (2 1/2)	76.200 (3)	38.350	71	73	2
	LRB 404828	—	480	63.500 (2 1/2)	76.200 (3)	44.700	71	73	2
	—	LRBZ 404824	410	63.500 (2 1/2)	76.200 (3)	38.350	71	73	1.5
	—	LRBZ 404828	480	63.500 (2 1/2)	76.200 (3)	44.700	71	73	1.5
	—	LRBZ 404828 B	480	63.500 (2 1/2)	76.200 (3)	44.700	71	73	1.5

Note⁽¹⁾ Maximum allowable fillet corner radius of shaft

Remark LRBZ has no oil hole. LRB and LRBZ...B are provided with an oil groove and an oil hole.

Assembled bearings

BR 324116
BR 324120
GBR 324116
GBR 324120 GBR 324120UU
BR 324120UU

BR 364824
BR 364828
GBR 364824
GBR 364828 GBR 364828UU
BR 364828UU

BR 405224
BR 405228
GBR 405224
GBR 405228 GBR 405228UU
BR 405228UU

BR 445624
BR 445628
GBR 445624
GBR 445628 GBR 445628UU
BR 445628UU

BR 486024
BR 486028
GBR 486024
GBR 486028 GBR 486028UU
BR 486028UU

1N=0.102kgf=0.2248lbs.
1mm=0.03937inch

INNER RINGS

Inner Rings for General Usage **Inch Series**

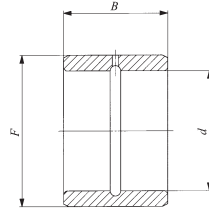

LRB

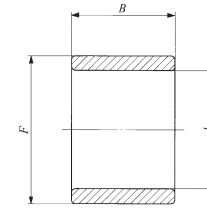

LRBZ

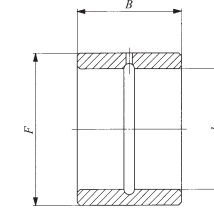

LRBZ...B

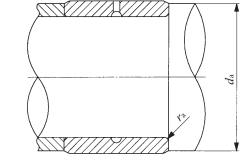

Shaft dia. 69.850 – 95.250mm

Shaft dia. mm (inch)	Identification number		Mass (Ref.) g	Boundary dimensions mm(inch)			Standard mounting dimensions mm		
				d	F	B	d_a		r_{as} max
						Min.	Max.	Max.	
69.850 (2 3/4)	LRB 445228	—	530	69.850 (2 3/4)	82.550 (3 1/4)	44.700	77	79	2
	LRB 445232	—	600	69.850 (2 3/4)	82.550 (3 1/4)	51.050	77	79	2
	—	LRBZ 445228	530	69.850 (2 3/4)	82.550 (3 1/4)	44.700	77	79	1.5
	—	LRBZ 445228 B	530	69.850 (2 3/4)	82.550 (3 1/4)	44.700	77	79	1.5
	—	LRBZ 445232	600	69.850 (2 3/4)	82.550 (3 1/4)	51.050	77	79	1.5
76.200 (3)	LRB 485632	—	640	76.200 (3)	88.900 (3 1/2)	51.050	83.5	86	2
	—	LRBZ 485632	640	76.200 (3)	88.900 (3 1/2)	51.050	83.5	86	1.5
	—	LRBZ 485632 B	640	76.200 (3)	88.900 (3 1/2)	51.050	83.5	86	1.5
82.550 (3 1/4)	LRB 526032	—	690	82.550 (3 1/4)	95.250 (3 3/4)	51.050	91	93	2.5
	—	LRBZ 526032	690	82.550 (3 1/4)	95.250 (3 3/4)	51.050	91	93	1.5
	—	LRBZ 526032 B	690	82.550 (3 1/4)	95.250 (3 3/4)	51.050	91	93	1.5
88.900 (3 1/2)	LRB 566432	—	750	88.900 (3 1/2)	101.600 (4)	51.050	97	99	2.5
	—	LRBZ 566432	750	88.900 (3 1/2)	101.600 (4)	51.050	97	99	1.5
95.250 (3 3/4)	—	LRBZ 606832	800	95.250 (3 3/4)	107.950 (4 1/4)	51.050	103	105	1.5

Note(1) Maximum allowable fillet corner radius of shaft

Remark LRBZ has no oil hole. LRB with inner ring bore diameter d of 76.200 mm or less and LRBZ...B are provided with an oil groove and an oil hole.

Other models are provided with an oil groove and two oil holes.

Assembled bearings

BR 526828
BR 526832
GBR 526828 GBR 526828UU
BR 526828UU
GBR 526832

BR 567232
GBR 567232 GBR 567232UU
BR 567232UU

BR 607632
GBR 607632 GBR 607632UU
BR 607632UU

BR 648032
GBR 648032 GBR 648032UU

GBR 688432 GBR 688432UU

H

IRT
IRB
LRT
LRB

1N=0.102kgf=0.2248lbs.
1mm=0.03937inch

CAM FOLLOWERS

- Standard Type Cam Followers
- Solid Eccentric Stud Type Cam Followers
- Eccentric Type Cam Followers
- Thrust Disk Type Cam Followers
- Capilube Cam Followers
- Centralized Lubrication Type Cam Followers
- Easy Mounting Type Cam Followers
- Heavy Duty Type Cam Followers
- Miniature Type Cam Followers
- Thrust Disk Type Miniature Cam Followers



Structure and Features

TURNUP Cam Followers are bearings with a stud incorporating needle rollers in a thick walled outer ring. These bearings are designed for outer ring rotation, and have superior rotational performance with a small coefficient of friction and high load capacity.

As studs already have threads or steps, they are easy to mount.

Cam Followers are follower bearings for cam mechanisms and linear motions and have high rigidity and

high accuracy. They are, therefore, used widely for machine tools, industrial robots, electronic devices, and OA equipment.

Stainless steel made Cam Followers are superior in corrosion resistance and suitable for applications in environments where oil cannot be used or water splashed, and in clean rooms.

Structure of Cam Followers

Structure of Standard Type Cam Follower⁽¹⁾
CF···BUJ

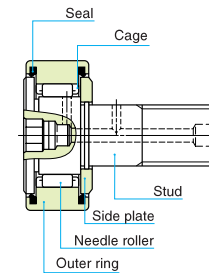

Structure of Thrust Disk Type Cam Follower
CF···WBUUR

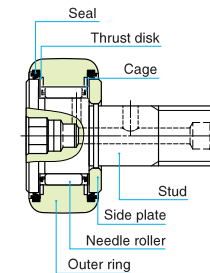

Structure of Capilube Cam Follower⁽²⁾
CF···WBUUR/SG

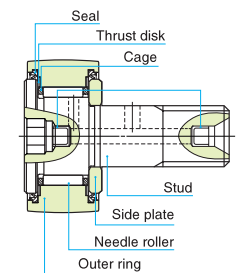

Structure of Heavy Duty Type Cam Follower
NUCF···BR

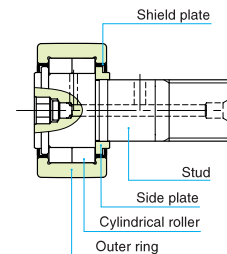

Structure of Miniature Type Cam Follower
CFS

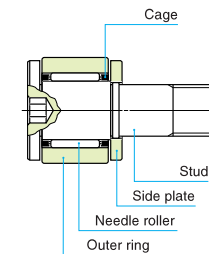

Note⁽¹⁾ In case of the stud diameter (d_1) 5 to 10mm, a lubrication fitting is provided in the stud head hex hole. The stud diameter (d_1) 12 to 30mm, a grease nipple is provided in the stud head hex hole.

⁽²⁾ For the detail of Capilube, please refer page A55.

I
CF
NUCF
CFS
CR

Types

For Cam Followers, the types shown in Table 1 are available.
Table 1 Type of Cam Followers

Type					With cage		Full complement	
					Crowned outer ring	Cylindrical outer ring	Crowned outer ring	Cylindrical outer ring
Metric CF series	Standard Type Cam Follower CF	High carbon steel made	With hexagon hole	Shield type	CF ... B R	CF ... B	CF ...VB R	CF ...VB
				Sealed type	CF ... BUUR	CF ... BUU	CF ...VBUUR	CF ...VBUU
			With screwdriver slot	Shield type	CF ... R	CF ...	CF ...V R	CF ...V
		Stainless steel made	With hexagon hole	Shield type	CF ... UUR	CF ... UU	CF ...V UUR	CF ...V UU
				Sealed type	CF ... FB R	CF ... FB	—	—
			With screwdriver slot	Shield type	CF ... FBUR	CF ... FBUR	—	—
	Solid Eccentric Stud Type Cam Follower CFES	High carbon steel made	With hexagon hole	Shield type	CFES ... B R	CFES ... B	—	—
				Sealed type	CFES ... BUUR	CFES ... BUU	—	—
		With screwdriver slot	Shield type	CFES ... R	CFES	—	—	
			Sealed type	CFES ... UUR	CFES ... UU	—	—	
	Eccentric Type Cam Follower CFE	High carbon steel made	With hexagon hole	Shield type	CFE ... B R	CFE ... B	CFE ...VB R	CFE ...VB
				Sealed type	CFE ... BUUR	CFE ... BUU	CFE ...VBUUR	CFE ...VBUU
		With screwdriver slot	Shield type	CFE ... R	CFE ...	CFE ...V R	CFE ...V	
			Sealed type	CFE ... UUR	CFE ... UU	CFE ...V UUR	CFE ...V UU	
	Thrust Disk Type Cam Follower CF ... W	High carbon steel made	With hexagon hole	Shield type	CF ...WB R	—	—	—
				Sealed type	CF ...WBUUR	—	—	—
		Stainless steel made	With hexagon hole	Shield type	CF ...FWB R	—	—	—
				Sealed type	CF ...FWBUUR	—	—	—
Centralized Lubrication Type Cam Follower CF-RU1, CF-FU1	High carbon steel made	With screwdriver slot	Sealed type	CF-RU1	CF-FU1	—	—	
			Sealed type	—	CF-SFU ...B	—	—	
Easy Mounting Type Cam Follower CF-SFU	High carbon steel made	With hexagon hole	Sealed type	—	CF-SFU	—	—	
			With screwdriver slot	Sealed type	—	CF-SFU	—	—
Capilube Cam Follower CF .../SG		High carbon steel made	With hexagon hole	Sealed type	CF ...WBUUR/SG	—	—	—
Heavy Duty Type Cam Follower NUCF		High carbon steel made	With hexagon hole	Shield type	—	—	NUCF ...BR	—
			With screwdriver slot	Shield type	—	—	NUCF ... R	—
Miniature CFS series	Miniature Type Cam Follower CFS	High carbon steel made Stainless steel made	With hexagon hole	Shield type	—	CFS	—	CFS ... V
				Shield type	—	CFS ... F	—	CFS ... FV
	Thrust Disk Type Miniature Cam Follower CFS ... W	High carbon steel made Stainless steel made	With hexagon hole	Shield type	—	CFS ... W	—	—
				Shield type	—	CFS ... FW	—	—
Inch series	Inch series Cam Follower CR	High carbon steel made	With hexagon hole	Shield type	CR ... B R	CR ... B	CR ...VB R	CR ...VB
				Sealed type	CR ... BUUR	CR ... BUU	CR ...VBUUR	CR ...VBUU
		With screwdriver slot	Shield type	CR ... R	CR ...	CR ...V R	CR ...V	
			Sealed type	CR ... UUR	CR ... UU	CR ...V UUR	CR ...V UUR	
	Inch series Heavy Duty Cam Follower CRH	High carbon steel made	With hexagon hole	Shield type	—	—	CRH ...VB R	CRH ...VB
				Sealed type	—	—	CRH ...VBUUR	CRH ...VBUU
With screwdriver slot	Shield type	—	—	CRH ...V R	CRH ...V			
	Sealed type	—	—	CRH ...V UUR	CRH ...V UU			

Standard Type Cam Followers

These are the basic type bearings in TURNUP Cam Follower series. Models with stud diameters ranging from 3 to 30 mm are prepared, and are suitable for a wide range of applications.

Solid Eccentric Stud Type Cam Followers

The stud of these bearings is eccentric to the center axis of the outer ring. Thus, the position of the outer ring in the radial direction in relation to the mating track surface can easily be adjusted by turning the stud, and the load distribution on a number of cam follower outer rings used on the same track surface can be made uniform.

These are eccentric cam followers with a one-piece stud that can be mounted in the same mounting holes as those for Standard Type Cam Followers. Eccentricity is 0.25 mm ~ 0.6 mm.

Eccentric Type Cam Followers

In these bearings, an eccentric collar is assembled with the Cam Follower stud, enabling the outer ring to be positioned easily in the radial direction against the mating track surface. Eccentricity is 0.4 ~ 1.5 mm.

Thrust Disk Type Cam Followers

These bearings have special resin thrust disk washers superior in wear and heat resistance between the sliding surfaces of outer ring shoulders, stud head and side plate. These disk washers reduce friction and wear due to axial loads caused by misalignment, etc.

Centralized Lubrication Type Cam Followers

These bearings have one or two pipe-threaded holes in the stud. Thus, this series is suitable when centralized lubrication is required.

Easy Mounting Type Cam Followers

These bearings have a stepped tapered portion on the stud. When mounting the Cam Follower, it is easy to fix its location by tightening a set screw to the stepped portion. Thus, this type is suitable when a large number of Cam Followers are used in a machine such as a pallet changer.

Capilube Cam Follower

These bearings are lubricated with a newly developed thermosetting solid-type lubricant which fills the inner space of the bearing. This lubricant provides long-term maintenance free.

Heavy Duty Type Cam Followers

These bearings are full complement type bearings incorporating double rows of full complement cylindrical rollers in the outer ring, and can withstand large radial loads and some axial loads.

Miniature Type Cam Followers

These are compactly designed bearings, incorporating very thin needle rollers in an outer ring with a small outside diameter. They are used in electronic devices, OA equipment, small index devices, etc.

Inch series Cam Followers

Two types, CR and CRH, are available in the Inch series Cam Followers. Black oxide film treatment is made on CRH models.

Lubrication method of Hex Head Cam Followers

<Types> Standard Type, Solid Eccentric Stud Type, Eccentric Type, Thrust Disk Type, Easy Mounting Type, Heavy Duty Type.

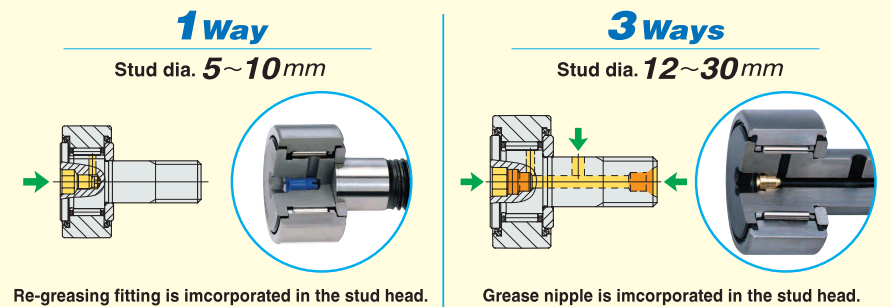

Remark : All of Easy Mounting Type are 1way port.

1N=0.102kgf=0.2248lbs.
1mm=0.03937inch

Internal Structures and Shapes

Various types are lined up in Cam Follower series, including the caged type, full complement type, shield type, sealed type, type with crowned outer ring, type

with cylindrical outer ring, type with hexagonal hole, etc.

Roller guide method

Cam Followers include the caged type and the full complement type. The caged type has a small coefficient of friction and is suitable for high speed rotations, while the full complement type is suitable for heavy loads at low speed rotations.

«With cage»

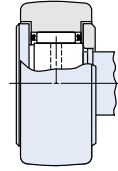

«Full complement»

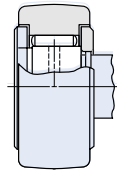

Seal structure

Cam Followers include the shield type and the sealed type. In the shield type, the narrow clearances between the outer ring and the stud flange and between the outer ring and the side plate form labyrinths.

The sealed type incorporates seals in the narrow clearances to prevent the penetration of foreign particles.

«Shield type»

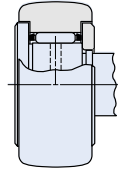

«Sealed type»

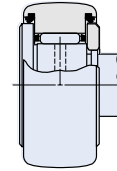

Shape of outer ring outside surface

The outside surface of the outer ring of Cam Followers, which makes direct contact with the mating track surface, is either crowned or cylindrical. The crowned outer rings are effective in moderating the edge load due to mounting errors. The cylindrical outer rings have a large contact area with the mating track surface, and are suitable for applications in which the applied load is large or the track surface hardness is low.

«Crowned outer ring»

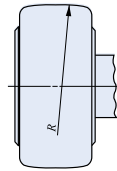

«Cylindrical outer ring»

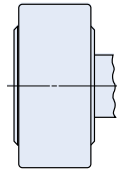

Shape of stud head

Cam Followers are available in two stud head shape types, namely, the type with screwdriver slot and the type with hexagon hole for hexagon bar wrench.

«With hexagon hole»

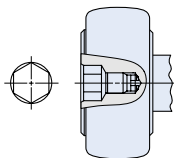

«With screwdriver slot»

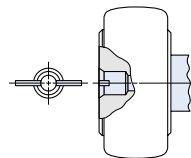

Identification number

Some examples of the identification number of Cam Followers are shown below.

Examples of identification number

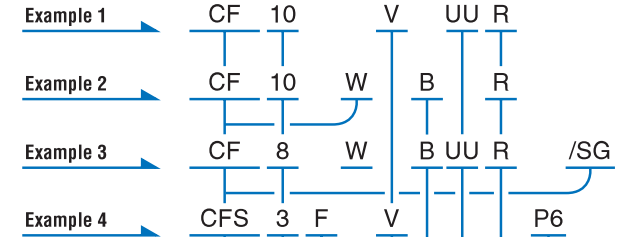

Model code	
CF	Standard Type Cam Follower
CFES	Solid Eccentric Stud Type Cam Follower
CFE	Eccentric Type Cam Follower
CF-W	Thrust Disk Type Cam Follower
CF-RU1	Centralized Lubrication Type Cam Follower (With crowned outer ring)
CF-FU1	Centralized Lubrication Type Cam Follower (With cylindrical outer ring)
CF-SFU	Easy Mounting Type Cam Follower
CF-/SG	Capilube Cam Follower
NUCF	Heavy Duty Type Cam Follower
Miniature CFS series	
CFS	Miniature Type Cam Follower
CFS-W	Thrust Disk Type Miniature Cam Follower
Inch series	
CR	Inch series Cam Follower
CRH	Inch series Cam Follower

Size	
The value indicates a stud diameter. (unit: mm)	
In the inch series, the outside diameter in units of 1/16 inch is indicated.	

Material	
No symbol	High carbon steel made
F	Stainless steel made

Roller guide method	
No symbol	With cage type
V	Full complement type

Shape of stud head	
B	With hexagon hole
No symbol	With screwdriver slot

Seal structure	
No symbol	Shield type
UU	Sealed type

Shape of outer ring outside surface	
R	With crowned outer ring
No symbol	With cylindrical outer ring

Classification symbol		
No symbol	Class 0	Applicable to Miniature CFS series
P6	Class 6	
P5	Class 5	
P4	Class 4	

I
CF
NUCF
CFS
CR

Accuracy

Table 2 Tolerances

unit: μm

Dimensions and symbols	Series	Metric CF series ⁽¹⁾		Miniature CFS series	Inch series	
		Crowned outer ring	Cylindrical outer ring		Crowned outer ring	Cylindrical outer ring
Outside dia. of outer ring D		0 ~ -50	See Table 3.1.	See Table 3.2.	0 ~ -50	0 ~ -25
Stud dia. d_1		h7		h6	+25 ~ 0	
Width of outer ring C		0 ~ -120	0 ~ -120	0 ~ -130		

Note⁽¹⁾ Also applicable to Heavy Duty Type Cam Followers.

Table 3.1 Tolerances and allowable values of outer rings (Metric CF series cylindrical outer rings)

unit: μm

D Nominal outside dia. of outer ring mm		Δ_{Dmp} Single plane mean outside dia. deviation		V_{Dsp} Outside dia. variation in a single radial plane (Max.)	V_{Dmp} Mean outside dia. variation (Max.)	K_{ca} Radial runout of assembled bearing outer ring (Max.)
Over	Incl.	High	Low			
6	18	0	- 8	10	6	15
18	30	0	- 9	12	7	15
30	50	0	-11	14	8	20
50	80	0	-13	16	10	25
80	120	0	-15	19	11	35

Table 3.2 Tolerances and allowable values of outer rings (Miniature CFS series)

unit: μm

Δ_{Dmp} Single plane mean outside dia. deviation								K_{ca} Radial runout of assembled bearing outer ring (Max.)			
Class 0		Class 6		Class 5		Class 4		Class 0	Class 6	Class 5	Class 4
High	Low	High	Low	High	Low	High	Low				
0	-8	0	-7	0	-5	0	-4	15	8	5	4

Table 3.3 Tolerances and allowable values of outer rings (Inch series cylindrical outer ring)

unit: μm

D Nominal outside dia. of outer ring mm		Δ_{Dmp} Single plane mean outside dia. deviation		V_{Dsp} Outside dia. variation in a single radial plane (Max.)	V_{Dmp} Mean outside dia. variation (Max.)	K_{ca} Radial runout of assembled bearing outer ring (Max.)
Over	Incl.	Over	Incl.			
6	18	0	-25	10	6	15
18	30			12	7	15
30	50			14	8	20
50	80			16	10	25
80	120			19	11	35

Clearance

The radial internal clearances of Cam Followers are shown in Table 4.

Table 4 Radial internal clearance

unit: μm

Metric CF series ⁽²⁾	Identification number ⁽¹⁾			Radial internal clearance	
	Heavy Duty Type Cam Followers NUCF	Miniature CFS series ⁽³⁾	Inch series	Min.	Max.
CF 3 ~ CF 5	—	CFS2 ~ CFS5	CR 8, CR 8-1, CRH 8-1, CRH 9	3	17
CF 6	—	CFS6	CR10, CR10-1, CRH10-1, CRH11	5	20
CF 8 ~ CF12-1	—	—	CR12 ~ CR22, CRH12 ~ CRH22	5	25
CF16 ~ CF20-1	—	—	CR24 ~ CR36, CRH24 ~ CRH36	10	30
CF24 ~ CF30-2	—	—	CRH40 ~ CRH56	10	40
—	—	—	CRH64	15	50
—	NUCF10 R ~ NUCF24 R	—	—	20	45
—	NUCF24-1R ~ NUCF30-2R	—	—	25	50

Notes⁽¹⁾ Also applicable to the full complement type, crowned outer ring type, sealed type, and type with hexagon hole.

⁽²⁾ Only representative types are shown in the table, but this table is applicable to the entire metric CF series.

⁽³⁾ Only representative types are shown in the table, but this table is applicable to the entire miniature CFS series.

Fit

Tables 5 and 6 show recommended tolerances of mounting holes for Cam Follower studs. Since the Cam Follower is supported in a cantilever position, the mounting hole diameter should be prepared with-out play between the stud and the hole especially when heavy shock loads are applied.

Table 5 Recommended fit

Type	Tolerance class of mounting hole for stud
Metric CF series	H7
Heavy Duty Type	H7
Miniature CFS series	H6
Inch series	F7

Table 6 Dimensional tolerances of mounting hole

unit: μm

Nominal outside dia. of stud mm		F7		H6		H7	
Over	Incl.	High	Low	High	Low	High	Low
—	3	+16	+ 6	+ 6	0	+10	0
3	6	+22	+10	+ 8	0	+12	0
6	10	+28	+13	+ 9	0	+15	0
10	18	+34	+16	+11	0	+18	0
18	30	+41	+20	+13	0	+21	0
30	40	+50	+25	+16	0	+25	0
40	50						

1N=0.102kgf=0.2248lbs.
1mm=0.03937inch

Maximum Allowable Static Load

The applicable load on Cam Followers is, in some cases, limited by the bending strength and shear strength of the stud and the strength of the outer ring instead of the load rating of the needle roller bearing. Therefore, the maximum allowable static load that is limited by these strengths is specified.

Track Capacity

Track capacity is defined as a load which can be continuously applied on a Cam Follower placed on a steel track surface without causing any deformation or indentation on the track surface when the outer ring of

the Cam Follower makes contact with the mating track surface (plane). The track capacities shown in Tables 7.1 and 7.2 are applicable when the hardness of the mating track surface is 40HRC (Tensile strength 1250N/mm²). When the hardness of the mating track surface differs from 40HRC, the track capacity is obtained by multiplying the value by the track capacity factor shown in Table 8.

If lubrication between the outer ring and the mating track surface is insufficient, seizure and/or wear may occur depending on the application. Therefore, attention must be paid to lubrication and surface roughness of the mating track especially for high-speed rotations such as cam mechanisms.

For lubrication between the outer ring and the mating track surface, C-Lube Unit for Cam Followers is recommended. (Refer page118)

Table 7.1 Track capacity

unit: N

Type	Identification number With crowned outer ring	Track capacity	Identification number With cylindrical outer ring	Track capacity
Metric CF series ⁽¹⁾	CF 3 R	542	CF 3	1 360
	CF 4 R	712	CF 4	1 790
	CF 5 R	794	CF 5	2 210
	CF 6 R	1 040	CF 6	3 400
	CF 8 R	1 330	CF 8	4 040
	CF10 R	1 610	CF10	4 680
	CF10-1R	2 030	CF10-1	5 530
	CF12 R	2 470	CF12	7 010
	CF12-1R	2 710	CF12-1	7 480
	CF16 R	3 060	CF16	11 200
	CF18 R	3 660	CF18	14 500
	CF20 R	5 190	CF20	23 200
	CF20-1R	4 530	CF20-1	21 000
	CF24 R	6 580	CF24	34 300
	CF24-1R	8 020	CF24-1	39 800
	CF30 R	9 220	CF30	52 700
	CF30-1R	9 990	CF30-1	56 000
	CF30-2R	10 800	CF30-2	59 300
Miniature CFS series ⁽²⁾	—	—	CFS2	220
	—	—	CFS2.5	298
	—	—	CFS3	485
	—	—	CFS4	799
	—	—	CFS5	1 210
	—	—	CFS6	1 680

Notes⁽¹⁾ Only representative types are shown in the table, but this table is applicable to the entire metric CF series, and also to Heavy Duty Type Cam Followers.

⁽²⁾ Only representative types are shown in the table, but this table is applicable to the entire miniature CFS series.

Table 7.2 Track capacity

unit: N

Type	Identification number With crowned outer ring	Track capacity	Identification number With cylindrical outer ring	Track capacity	Identification number With cylindrical outer ring	Track capacity
Inch series ⁽¹⁾	CR 8 R	770	CR 8	2 140	—	—
	CR 8-1R	770	CR 8-1	2 360	CRH 8-1	2 360
	—	—	—	—	CRH 9	2 650
	CR10 R	1 030	CR10	3 210	—	—
	CR10-1R	1 030	CR10-1	3 480	CRH10-1	3 480
	—	—	—	—	CRH11	3 830
	CR12 R	1 340	CR12	4 500	CRH12	4 500
	CR14 R	1 630	CR14	5 250	CRH14	5 250
	CR16 R	1 970	CR16	7 280	CRH16	7 280
	CR18 R	2 300	CR18	7 710	CRH18	7 710
	CR20 R	2 680	CR20	10 700	CRH20	10 700
	CR22 R	3 050	CR22	11 800	CRH22	11 800
	CR24 R	3 410	CR24	15 400	CRH24	15 400
	CR26 R	3 820	CR26	16 700	CRH26	16 700
	CR28 R	4 210	CR28	21 000	CRH28	21 000
	CR30 R	4 610	CR30	22 500	CRH30	22 500
	CR32 R	5 050	CR32	30 900	CRH32	30 900
	CR36 R	5 900	CR36	34 700	CRH36	34 700
	—	—	—	—	CRH40	45 000
	—	—	—	—	CRH44	49 500
	—	—	—	—	CRH48	64 300
	—	—	—	—	CRH52	69 600
	—	—	—	—	CRH56	87 000
	—	—	—	—	CRH64	113 000

Note⁽¹⁾ Only representative types are shown in the table, but this table is applicable to the entire inch series.

Table 8 Track capacity factor

Hardness HRC	Tensile strength N/mm ²	Track capacity factor	
		With crowned outer ring	With cylindrical outer ring
20	760	0.22	0.37
25	840	0.31	0.46
30	950	0.45	0.58
35	1 080	0.65	0.75
38	1 180	0.85	0.89
40	1 250	1.00	1.00
42	1 340	1.23	1.15
44	1 435	1.52	1.32
46	1 530	1.85	1.51
48	1 635	2.27	1.73
50	1 760	2.80	1.99
52	1 880	3.46	2.29
54	2 015	4.21	2.61
56	2 150	5.13	2.97
58	2 290	6.26	3.39

1N=0.102kgf=0.2248lbs.
1mm=0.03937inch

Allowable Rotational Speed

The allowable rotational speed of Cam Followers is affected by mounting and operating conditions. For reference, Table 9 shows $d_1 n$ values when only pure radial loads are applied. Considering that axial loads also act under actual operating conditions, the recommended $d_1 n$ value is 1/10 of the value shown in the table.

Table 9 $d_1 n$ values of Cam Followers ⁽¹⁾⁽²⁾

Lubricant	Grease	Oil
Caged type	84 000	140 000
Full complement type	42 000	70 000
Heavy Duty Type Cam Follower	66 000	110 000

Notes⁽¹⁾ $d_1 n$ value = $d_1 \times n$
 where, d_1 : Stud diameter mm
 n : Rotational speed rpm

⁽²⁾ In case of Capilube Cam Follower, $d_1 n$ value is 10000.
 In case of Capilube Cam Follower with axial loads, $d_1 n$ value is 10000 or 1/10 of the above table values, whichever smaller.

Table 10 Grease-prepacked Cam Followers

○ : With prepacked grease × : Without prepacked grease

Series Size of stud dia. d_1 (1) mm	Type	With cage				Full complement type
		Shield type		Sealed type		
		With hexagon hole	With screwdriver slot	With hexagon hole	With screwdriver slot	
Metric CF series	CF	3~5	○	○	○	—
	CFES	6~10	○	○	○	○
	CFE	12~30	×	×	○	○
	CF...W					
	CF-RU1, CF-FU1	—	—	—	○	—
	CF-SFU	—	—	×	○	—
	Capilube Cam Followers CF.../SG ⁽²⁾	—	—	×	—	—
	Heavy Duty Type Cam Followers NUCF	—	—	—	—	○
Miniature CFS series	CFS	○	—	—	—	○
	CFS...W	○	—	—	—	○
Inch series	CR	○	○	○	○	○
	CRH	—	—	—	—	○

Notes⁽¹⁾ For Eccentric Type Cam Followers (CFE), thread diameter G shown in the table of dimensions is applicable.

⁽²⁾ This Cam Follower incorporates Capilube which includes a large amount of lubricating oil.

Lubrication

Grease-prepacked Cam Followers are shown in Table 10. The lubricating grease prepacked in these bearings is ALVANIA GREASE S2 (SHELL).

For Cam Followers without prepacked grease, grease should be packed through the oil hole in the stud for use. If they are used without grease, wear of rolling contact surfaces may take place, leading to a short bearing life.

Oil Hole

The position of oil hole is shown in Table 11. Re-greasing cannot be made for models without an oil hole.

Grease should be supplied gently with a straight type grease gun as specified by JIS B 9808:1991, which is applied carefully to the nipple head from the front.

Table 11 Position of oil hole

○ : Oil hole is prepared.

Series Size of stud dia. d_1 (1) mm	Position of oil hole			① Stud head	② Stud outside surface	③ Stud end
	①	②	③			
Metric CF series	CF	With hexagon hole	$d_1 < 5$	—	—	—
			$5 \leq d_1 \leq 10$	○ ⁽²⁾	—	—
		$10 < d_1$	○ ⁽³⁾	○	○	
	CFES	With hexagon hole	$d_1 < 5$	—	—	—
			$5 \leq d_1 \leq 10$	○	—	—
		$10 < d_1$	○	○	○	
	CFE	With screwdriver slot	$d_1 < 5$	—	—	—
			$5 \leq d_1 \leq 10$	○	—	—
	CF...W	With screwdriver slot	$d_1 < 5$	—	—	—
			$5 \leq d_1 \leq 10$	○	—	—
CF-RU1, CF-FU1 ⁽⁴⁾	With screwdriver slot	$d_1 \leq 12$	○	—	—	
		$12 < d_1$	○	○	○	
CF-SFU	With hexagon hole	$d_1 \leq 10$	○ ⁽²⁾	—	—	
		$10 < d_1$	○ ⁽⁵⁾	—	—	
C-Lube Cam Followers CF.../SG	With screwdriver slot	$d_1 \leq 10$	—	—	—	
		$10 < d_1$	—	○	—	
Miniature CFS series	CFS	—	—	—	—	
	CFS...W	—	—	—	—	
Heavy Duty Type Cam Followers	NUCF	With hexagon hole	$d_1 \leq 10$	○ ⁽²⁾	—	—
			$10 < d_1$	○ ⁽³⁾	○	○
Inch series	CR	With hexagon hole	$d_1 \leq 6.35$	—	—	—
			$6.35 < d_1$	—	○	○
CRH	With hexagon hole	With screwdriver slot	$d_1 \leq 6.35$	○	—	—
			$6.35 < d_1$	○	○	○
	With hexagon hole	With screwdriver slot	$d_1 \leq 7.938$	—	—	—
			$7.938 < d_1$	—	○	○
CRH	With hexagon hole	With screwdriver slot	$d_1 \leq 7.938$	○	—	—
			$7.938 < d_1$	○	○	○

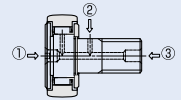

Notes⁽¹⁾ In case of Eccentric Type Cam Followers (CFE), thread diameter G shown in the table of dimensions is applicable in place of stud dia. and the oil hole on the outer surface of the stud cannot be used for lubrication.

⁽²⁾ Re-lubrication can be made from the re-greasing fitting that is inserted into the hexagon hole. Refer to page 14.

⁽³⁾ Grease nipple is incorporated in the hexagon hole. Re-greasing can be made from the stud end by press fitting a supplied grease nipple into the stud end. Refer to page 14.

⁽⁴⁾ Tapped holes for oil connectors are provided at the stud end and hole of the head.

⁽⁵⁾ Re-greasing can be made from the grease nipple in the hexagon hole.

⁽⁶⁾ Re-greasing is not possible as the bearing internal space is filled with thermosetting solid-type lubricant C-Lube.

1N=0.102kgf=0.2248lbs.

1mm=0.03937inch

Table 12 Types and Dimension of Lubrication Nozzles

Type	Dimension	Applicable grease nipple and re-grease fitting
A-5126T		NPF4-1 (1) NPF6-1 (1) Re-grease fitting
A-5120R		NPF4-1 (1) NPF6-1 (1)
B-5120R		
A-5120V		
A-5240V		NPT4 NPT6 NPT8 NPB2 NPB3 NPB3-1
B-5120V		
B-5240V		

Note(1) HSP-3(Yamada Corporation)can be used for them.

Remark The above nozzles can be attached on the standard grease gun shown below.

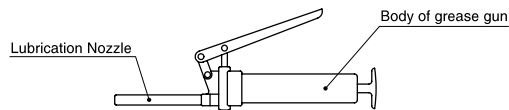

Accessories

Cam Follower accessories are shown in Table 12.
Grease nipple dimensions are shown in Table 13.
Dimensions of plug for unused oil hole and dimensions of plug inserter are shown in Table 14.

Table 13 Accessories

○ : Attached

Series		Accessories		Grease nipple	Plug	Nut	Spring washer	
Size of stud dia. d_1 mm								
Metric CF series	CF	With hexagon hole	$d_1 \leq 10$	—	—	○	— ⁽²⁾	
			$10 < d_1$	○	—	○	— ⁽²⁾	
	CFE	With screwdriver slot	$d_1 < 5$	—	—	○	— ⁽²⁾	
			$5 \leq d_1$	○	○	○	— ⁽²⁾	
	CF...W				—	—	○	—
CF-RU1, CF-FU1				—	—	○	—	
CF-SFU				—	—	—	—	
Capilube Cam Followers		CF.../SG		—	—	○	—	
Heavy Duty Type Cam Followers	NUCF	With hexagon hole	$d_1 \leq 10$	—	—	○	—	
			$10 < d_1$	○	—	○	—	
		With screwdriver slot		—	○	○	—	
Miniature CFS series	CFS			—	—	○	—	
	CFS...W			—	—	○	—	
Inch series	CR	With hexagon hole	$d_1 \leq 6.35$	—	—	○	—	
			$6.35 < d_1$	○	○	○	—	
			With screwdriver slot		—	○	○	—
	CRH	With hexagon hole	$d_1 \leq 7.938$	—	—	○	—	
$7.938 < d_1$			○	○	○	—		
		With screwdriver slot		—	○	○	—	

Notes(1) For Eccentric Type Cam Follower CFE, thread diameter G is applied.

(2) For CFE, spring washer is supplied.

I

CF
NUCF
CFS
CR

1N=0.102kgf=0.2248lbs.
1mm=0.03937inch

Table 14 Dimensions of grease nipple

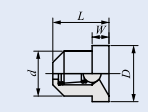
Code number	Dimensions mm						Applicable Cam Followers (1)	
	d	D	D ₁	L	L ₁	W		
NPF4-1	4	5	—	5	—	1.5	CF12B ~ CF16B	
NPF6-1	6	7	—	8	—	2	CF18B ~ CF30B	
NPT4	4	7.5	6	10	5.5	1.5	CF 6 ~ CF10-1	
NPT6	6	8	6	11	6	2	CF12 ~ CF18	
NPT8	8	10	6	16	7	3	CF20 ~ CF30-2	
NPB2	3.18	7.5	6	9	5.5	1.5	CF5	

Note(1) Only representative types are shown in the table. This table is also applicable to Heavy Duty Type Cam Followers.

Table 15 Dimensions of Grease nipple for Inch series

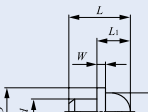
Code number	Dimensions mm						Applicable Cam Followers (1)	
	d	D	D ₁	L	L ₁	W		
NPB2	3.18	7.5	6	9	5.5	1.5	CR8 ~ CR10-1, CRH8-1 ~ CRH11	
NPB3	4.76	7.5	6	10	5.5	1.5	CR12 ~ CR22, CRH12 ~ CRH22	
NPB3-1	4.76	7.5	6	12.5	5.5	1.55	CR24 ~ CR36, CRH24 ~ CRH44	
NPB4	6.35	8.5	6	13	6	2	CR48, CRH48 ~ CRH64	

Note(1) Only representative types are shown in the table.

Table 16 Dimensions of plug

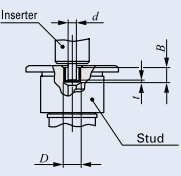
Code number	Dimensions of plug mm			Dimension of inserter mm	Applicable Cam Followers (1)	
	D	t	B			
UST4F	4	0.4	3.3	3	CF 6 ~ CF10-1	
UST6F	6	0.4	4	5	CF12 ~ CF18	
UST8F	8	0.4	5.8	7	CF20 ~ CF30-2	
USB2F	3.18	0.3	3.3	2.3	CF5, CR8 ~ CR10-1	
USB3F	4.76	0.4	4.3	3.7	CR12 ~ CR36, CRH12 ~ CRH44	
USB4F	6.35	0.5	4.8	5.2	CRH48 ~ CRH64	

Note(1) Only representative types are shown in the table. This table is also applicable to Heavy Duty Type Cam Followers.

Operating Temperature Range

The operating temperature range for TURNUP Cam Followers is -20 °C ~ +120 °C. However, the maximum allowable temperature for the following types is different.

The maximum allowable temperature for the Metric CF series with a stud diameter d_1 of 4 mm or less, Stainless steel mede Cam Followers with a stud diameter d_1 of 5 mm and CFS2 is +110 °C, and +100 °C when they are continuously operated.

The maximum allowable temperature for the sealed type with a stud diameter d_1 of 5 mm or less is +80 °C.

Allowable temperature range of C-Lube Cam Followers is -15 °C ~ +80 °C. For a long term operation, less than +60 °C is recommended.

Mounting

1 Make the center axis of the mounting hole perpendicular to the moving direction of the Cam Follower and match the side shoulder accurately with the seating surface indicated by dimension f in the table of dimensions. (See Fig. 1.) Then, fix the Cam Follower with the nut. Do not hit the flange head of the Cam Follower directly with a hammer, etc. This may lead to a bearing failure such as irregular rotation or cracking.

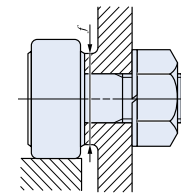

Fig. 1 Seating surface

2 The TURNUP mark on the flange head of the stud indicates the position of the oil hole on the raceway. Avoid locating the oil hole within the loading zone. This may lead to a short bearing life. (See Fig. 2.) The hole located in the middle part of the stud perpendicular to the stud center axis is used for greasing or locking.

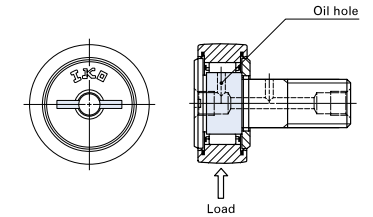

Fig. 2 Oil hole position and loading direction

3 When tightening the nut, the tightening torque should not exceed the values shown in the table of dimensions. If the tightening torque is too large, it is possible that the threaded portion of the stud will be broken. When there is a possibility of loosening, a special nut such as a lock nut, spring washer, or self-locking nut should be used.

4 In the case of Solid Eccentric Stud Type Cam Followers and Eccentric Type Cam Followers, the outer ring position can be adjusted appropriately by turning the stud with a screwdriver or hexagon bar wrench using the screwdriver slot or hexagon hole of the stud head. The stud is fixed with a nut and a spring washer, etc. The tightening torque should not exceed the values of maximum tightening torque shown in the table of dimensions. When shock loads are applied and the adjusted eccentricity has to be ensured, it is recommended to make holes in the housing, stud and eccentric collar, and fix the stud with a dowel pin as shown in Fig. 3. However, when the stud diameter is less than 8 mm (Eccentric collar diameter 11 mm), it is difficult to make a hole in the stud because the stud is through-hardened.

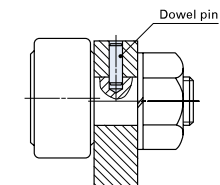

Fig. 3 Mounting example of Solid Eccentric Stud Type Cam Follower

1N=0.102kgf=0.2248lbs.
1mm=0.03937inch

⑤ In case of Eccentric Type Cam Follower (CFE), the length of the mounting hole should be more than 0.5 mm longer than the dimension B_3 (Eccentric collar width) shown in the table of dimensions. (See Fig. 4.)

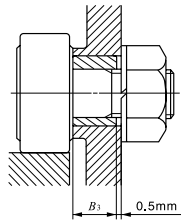

Fig. 4 Length of the mounting hole of Eccentric Type Cam Follower

⑥ For mounting Easy Mounting Type Cam Followers, it is recommended to fix the fixing screw from the upper side to the stepped portion of the stud. (See Fig. 5.)

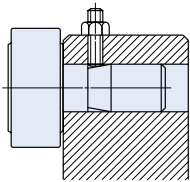

Fig. 5 Mounting example of Easy Mounting Type Cam Follower

ption Part

C Lube Unit for Cam Followers

C-Lube Unit CL is the lubrication-supporting equipment for the track surface and Cam Follower's outer ring to keep both surfaces free of maintenance.

In its open pores, Capillary system always supplies proper amount of lubrication oil to the cylindrical rollers and lubrication condition of the raceway can be kept well for long period of time.

Capillary system TURNUP has developed is a new type lubrication. It is a porous resin Lube-body or plate with steel backing formed by sintering fine resin powder and impregnating a large amount of lubrication oil.

Also it prevents oil scattering causing pollution to the surrounding environment, and helps minimizing oil consumption.

Structure of C-Lube Unit for Cam Followers

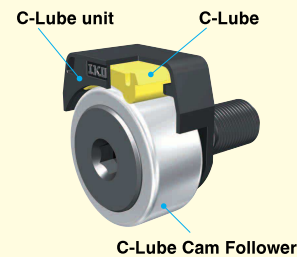

Magnified photos of C-Lube

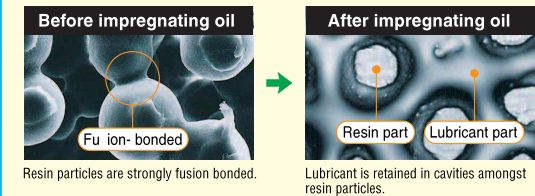

Identification number

The identification number example of TURNUP C-Lube Unit is shown below.

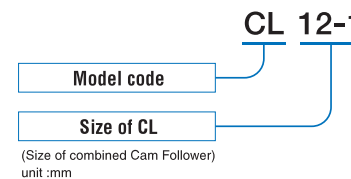

Allowable rotation speed

The rotation speed of TURNUP Cam Follower with C-Lube Unit should not exceed $d_1 n = 10,000$ for reference.

$$d_1 n = d_1 \times n$$

d_1 : Stud diameter of Cam Follower, mm
 n : Rotational speed, rpm

Minimum rotational angle

Lubricating oil is supplied to the whole external diameter surface of the outer ring. Accordingly, use the product in a condition in which the outer ring makes one or more turns.

Operating temperature

Allowable operating temperature range of TURNUP Cam Follower with C-Lube Unit is -15 to 80°C.

$$1N = 0.102 \text{kgf} = 0.2248 \text{lbs.}$$

$$1\text{mm} = 0.03937 \text{inch}$$

Mounting

- Set the C-Lube Unit perpendicularly to the center axis of Cam Follower and fix together with Cam Follower by tightening nut.

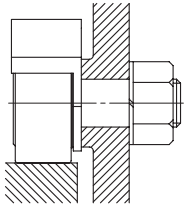

- Position of C-Lube Unit is adjustable. C-Lube Unit must be positioned avoiding loading direction.

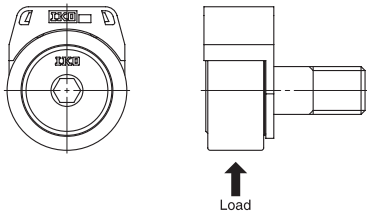

- When tightening the nut, the tightening torque should not be exceeded the value maximum tightening torque on dimension table. In case loosening of the nut is predicted due to vibration, using lock nut, spring washer and other special washer are recommended.

For use

- The maximum allowable load on TURNUP Cam Follower with C-Lube Unit is, in some cases, limited by the bending strength and shear strength of the C-Lube Unit instead of the load rating of needle bearing part. In order to safety operation, the maximum allowable static load is specified by the limitations of those strengths.
- After assembling C-Lube Unit and Cam Followers in the machine, please confirm that C-Lube unit provides oil correctly to the track surface before actual operation.
- Do not use in the environment which contamination of liquid and/or harmful foreign matter are expected.
- Do not wash with organic solvent and/or white kerosene, which have the ability of removing fat nor leave them in contact with the above agents.
- To ensure normal rotation of the Cam Follower, apply a load of 1% or over of the dynamic load rating at use.
- Replace with new C-Lube Unit when inside oil finishes completely. Re-lubrication is not possible.
- Do not apply a load onto the C-Lube Unit directly.

Table 19 Dimensions of C-Lube Unit for Cam Followers

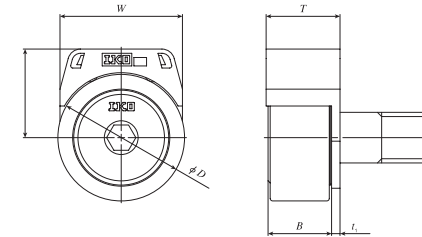

Model number	Boundary Dimensions mm				Applicable Cam Followers			Maximum allowable static load N ⁽²⁾
	W	H	T	l ₁	Model number ⁽¹⁾	Boundary Dimensions mm D B Max		
CL 6	15.4	12.6	14	1.5	CF 6 B	16 12.2	1 560	
CL 8	18.4	14.2	14	1.5	CF 8 B	19 12.2	3 700	
CL 10	21	17	15.5	2	CF 10 B	22 13.2	5 510	
CL 10-1	21	19.2	15.5	2	CF 10-1 B	26 13.2	5 510	
CL 12	29	21	17.5	2	CF 12 B	30 15.2	7 830	
CL 12-1	29	22	17.5	2	CF 12-1 B	32 15.2	7 830	

Note⁽¹⁾ Only representative types shown in the table, but also applicable to the same size of standard type, with thrust washer type, centralized lubrication type, C-Lube maintenance free type and heavy duty type. Combine with C-Lube Cam Follower is strongly recommended for full maintenance free.

⁽²⁾ Actual load should be not exceeded these values.

1N ≒ 0.102kgf

I

CF
NUCF
CFS
CR

1N=0.102kgf=0.2248lbs.
1mm=0.03937inch

CAM FOLLOWERS

Capilube Cam Followers **With Cage / With Hexagon Hole**

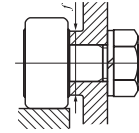
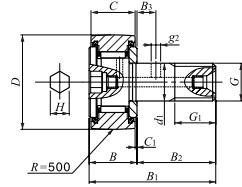
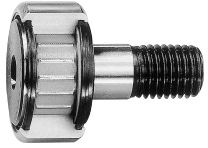

Stud dia. 6–12mm

CF...WBUUR/SG

Stud dia. mm	Identification number	Mass (Ref.) g	Boundary dimensions mm						
			D	C	d ₁	G	G ₁	B _{max}	B _{1max}
6	CF 6 WBUUR/SG	18.5	16	11	6	M 6×1	8	12.2	28.2
8	CF 8 WBUUR/SG	28.5	19	11	8	M 8×1.25	10	12.2	32.2
10	CF 10 WBUUR/SG	45	22	12	10	M10×1.25	12	13.2	36.2
	CF 10-1 WBUUR/SG	60	26	12	10	M10×1.25	12	13.2	36.2
12	CF 12 WBUUR/SG	95	30	14	12	M12×1.5	13	15.2	40.2
	CF 12-1 WBUUR/SG	105	32	14	12	M12×1.5	13	15.2	40.2

Remark Models with a stud diameter d_1 of 10 mm or less has no oil hole. The others are provided with one oil hole each on the outside surface and end surface of the stud.

B ₂	B ₃	C ₁	g ₂	H	Mounting dimension f Min. mm	Maximum tightening torque N·m	Basic dynamic load rating C N	Basic static load rating C ₀ N	Maximum allowable load N
16	—	0.6	—	3	11	2.7	3 660	3 650	1 950
20	—	0.6	—	4	13	6.5	4 250	4 740	4 620
23	—	0.6	—	4	16	13.8	5 430	6 890	6 890
	—	0.6	—	4	16	13.8	5 430	6 890	6 890
25	6	0.6	3	6	21	21.9	7 910	9 790	9 790
25	6	0.6	3	6	21	21.9	7 910	9 790	9 790

I
CF
NUCF
CFS
CR

CAM FOLLOWERS

Standard Type Cam Followers **With Cage/With Hexagon Hole**

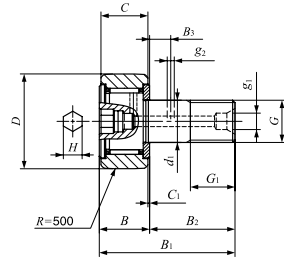

CF...BR

Stud dia. 3–30 mm

Stud dia. mm	Identification number				Mass (Ref.) g	D	C	d ₁	G
	Shield type		Sealed type						
	With crowned outer ring	With cylindrical outer ring	With crowned outer ring	With cylindrical outer ring					
3	CF 3 BR	CF 3 B	CF 3 BUUR	CF 3 BUU	4.3	10	7	3	M 3×0.5
4	CF 4 BR	CF 4 B	CF 4 BUUR	CF 4 BUU	7.4	12	8	4	M 4×0.7
5	CF 5 BR	CF 5 B	CF 5 BUUR	CF 5 BUU	10.3	13	9	5	M 5×0.8
6	CF 6 BR	CF 6 B	CF 6 BUUR	CF 6 BUU	18.5	16	11	6	M 6×1
8	CF 8 BR	CF 8 B	CF 8 BUUR	CF 8 BUU	28.5	19	11	8	M 8×1.25
	CF 8 BRM	CF 8 BM	CF 8 BUURM	CF 8 BUUM	28.5	19	11	8	M 8×1
10	CF 10 BR	CF 10 B	CF 10 BUUR	CF 10 BUU	45	22	12	10	M10×1.25
	CF 10 BRM	CF 10 BM	CF 10 BUURM	CF 10 BUUM	45	22	12	10	M10×1
	CF 10-1 BR	CF 10-1 B	CF 10-1 BUUR	CF 10-1 BUU	60	26	12	10	M10×1.25
	CF 10-1 BRM	CF 10-1 BM	CF 10-1 BUURM	CF 10-1 BUUM	60	26	12	10	M10×1
12	CF 12 BR	CF 12 B	CF 12 BUUR	CF 12 BUU	95	30	14	12	M12×1.5
	CF 12-1 BR	CF 12-1 B	CF 12-1 BUUR	CF 12-1 BUU	105	32	14	12	M12×1.5
16	CF 16 BR	CF 16 B	CF 16 BUUR	CF 16 BUU	170	35	18	16	M16×1.5
18	CF 18 BR	CF 18 B	CF 18 BUUR	CF 18 BUU	250	40	20	18	M18×1.5
20	CF 20 BR	CF 20 B	CF 20 BUUR	CF 20 BUU	60	52	24	20	M20×1.5
	CF 20-1 BR	CF 20-1 B	CF 20-1 BUUR	CF 20-1 BUU	85	47	24	20	M20×1.5
24	CF 24 BR	CF 24 B	CF 24 BUUR	CF 24 BUU	815	62	29	24	M24×1.5
	CF 24-1 BR	CF 24-1 B	CF 24-1 BUUR	CF 24-1 BUU	1 140	72	29	24	M24×1.5
30	CF 30 BR	CF 30 B	CF 30 BUUR	CF 30 BUU	1 870	80	35	30	M30×1.5
	CF 30-1 BR	CF 30-1 B	CF 30-1 BUUR	CF 30-1 BUU	2 030	85	35	30	M30×1.5
	CF 30-2 BR	CF 30-2 B	CF 30-2 BUUR	CF 30-2 BUU	2 220	90	35	30	M30×1.5

Note(*) Minimum allowable value of chamfer dimension *r*

Remarks 1. Models with a stud diameter *d*₁ of 4 mm or less have no oil hole. For models with a stud dia. 5 to 10mm, oil hole (re-greasing fitting) is provided at the head. Other models are provided with an oil hole (grease nipple) at the head and an oil hole each on the outside surface and end surface of the stud.

2. Shield type models with a stud diameter *d*₁ of 10mm or less and the sealed type models are provided with prepacked grease. Other models are not provided with prepacked grease. Perform proper lubrication for use.

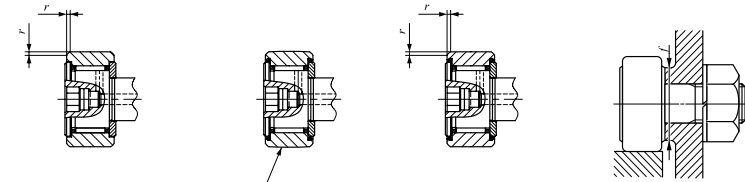

CF...B

CF...BUUR

CF...UU

Boundary dimensions mm											Mounting dimension <i>f</i> Min. mm	Maximum tightening torque N·m	Basic dynamic load rating <i>C</i> N	Basic static load rating <i>C</i> ₀ N	Maximum allowable static load N
<i>G</i> ₁	<i>B</i>	<i>B</i> ₁	<i>B</i> ₂	<i>B</i> ₃	<i>C</i> ₁	<i>g</i> ₁	<i>g</i> ₂	<i>H</i>	<i>r</i> _{s min} ^(*)						
	8	17		—	0.5	—	—	2	0.2	6.8	0.3	1 500	1 020	84	
6	9	20	11	—	0.5	—	—	2.5	0.3	8.3	0.78	2 070	1 590	834	
7.5	10	23	13	—	0.5	—	—	3	0.3	9.3	1.6	2 520	2 140	1 260	
8	12.2 ax	28.2max	16	—	0.6	—	—	3	0.3	11	2.7	3 660	3 650	1 950	
10	12.2max	32.2max	20	—	0.6	—	—	4	0.3	13	6.5	4 250	4 740	4 620	
10	12.2max	32.2max	20	—	0.6	—	—	4	0.3	13	7.1	4 250	4 740	4 620	
12	13.2max	36.2max	23	—	0.6	—	—	4	0.3	16	13.8	5 430	6 890	6 890	
12	13.2max	36.2max	23	—	0.6	—	—	4	0.3	16	14.7	5 430	6 890	6 890	
12	13.2max	36.2max	23	—	0.6	—	—	4	0.3	16	13.8	5 430	6 890	6 890	
12	13.2max	36.2max	23	—	0.6	—	—	4	0.3	16	14.7	5 430	6 890	6 890	
13	15.2max	40.2max	25	6	0.6	6	3	6	0.6	21	21.9	7 910	9 790	9 790	
13	15.2max	40.2max	25	6	0.6	6	3	6	0.6	21	21.9	7 910	9 790	9 790	
17	19.6max	52.1max	32.5	8	0.8	6	3	6	0.6	26	58.5	12 000	18 300	18 300	
19	21.6max	58.1max	36.5	8	0.8	6	3	8	1	29	86.2	14 800	25 200	25 200	
21	25.6max	66.1max	40.5	9	0.8	8	4	8	1	34	119	20 700	34 600	34 600	
21	25.6max	66.1max	40.5	9	0.8	8	4	8	1	34	119	20 700	34 600	34 600	
25	30.6max	80.1max	49.5	11	0.8	8	4	12	1	40	215	30 500	52 600	52 000	
25	30.6max	80.1max	49.5	11	0.8	8	4	12	1	40	215	30 500	52 600	52 000	
32	37 max	100 max	63	15	1	8	4	17	1	49	438	45 400	85 100	85 100	
32	37 max	100 max	63	15	1	8	4	17	1	49	438	45 400	85 100	85 100	
32	37 max	100 max	63	15	1	8	4	17	1	49	438	45 400	85 100	85 100	

I
CF
NUCF
CFS
CFR

CAM FOLLOWERS

Standard Type Cam Followers With Cage/With Screwdriver Slot

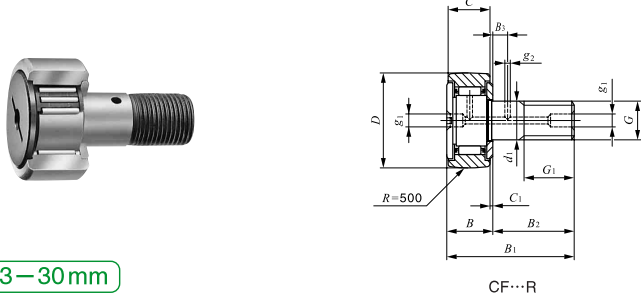

Stud dia. 3–30 mm

Stud dia. mm	Identification number					Mass (Ref.) g	D	C	d_1	G
	Shield type		Sealed type							
	With crowned outer ring	With cylindrical outer ring	With crowned outer ring	With cylindrical outer ring						
3	CF 3 R	CF 3	CF 3 UUR	CF 3 UU	4.3	10	7	3	M 3×0.5	
4	CF 4 R	CF 4	CF 4 UUR	CF 4 UU	7.4	12	8	4	M 4×0.7	
5	CF 5 R	CF 5	CF 5 UUR	CF 5 UU	10.3	13	9	5	M 5×0.8	
6	CF 6 R	CF 6	CF 6 UUR	CF 6 UU	18.5	16	11	6	M 6×1	
8	CF 8 R	CF 8	CF 8 UUR	CF 8 UU	28.5	19	11	8	M 8×1.25	
	CF 8 RM	CF 8 M	CF 8 UURM	CF 8 UUM	28.5	19	11	8	M 8×1	
10	CF 10 R	CF 10	CF 10 UUR	CF 10 UU	45	22	12	10	M10×1.25	
	CF 10 RM	CF 10 M	CF 10 UURM	CF 10 UUM	45	22	12	10	M10×1	
	CF 10-1 R	CF 10-1	CF 10-1 UUR	CF 10-1 UU	60	26	12	10	M10×1.25	
	CF 10-1 RM	CF 10-1 M	CF 10-1 UURM	CF 10-1 UUM	60	26	12	10	M10×1	
12	CF 12 R	CF 12	CF 12 UUR	CF 12 UU	95	30	14	12	M12×1.5	
	CF 12-1 R	CF 12-1	CF 12-1 UUR	CF 12-1 UU	105	32	14	12	M12×1.5	
16	CF 16 R	CF 16	CF 16 UUR	CF 16 UU	170	35	18	16	M16×1.5	
18	CF 18 R	CF 18	CF 18 UUR	CF 18 UU	250	40	20	18	M18×1.5	
20	CF 20 R	CF 20	CF 20 UUR	CF 20 UU	460	52	24	20	M20×1.5	
	CF 20-1 R	CF 20-1	CF 20-1 UUR	CF 20-1 UU	385	47	24	20	M20×1.5	
24	CF 24 R	CF 24	CF 24 UUR	CF 24 UU	815	62	29	24	M24×1.5	
	CF 24-1 R	CF 24-1	CF 24-1 UUR	CF 24-1 UU	1 140	72	29	24	M24×1.5	
30	CF 30 R	CF 30	CF 30 UUR	CF 30 UU	1 870	80	35	30	M30×1.5	
	CF 30-1 R	CF 30-1	CF 30-1 UUR	CF 30-1 UU	2 030	85	35	30	M30×1.5	
	CF 30-2 R	CF 30-2	CF 30-2 UUR	CF 30-2 UU	2 220	90	35	30	M30×1.5	

Note(*) Minimum allowable value of chamfer dimension r

Remarks1. Models with a stud diameter d_1 of 4 mm or less have no oil hole. Models with a stud diameter of more than 5 mm and up to 10 mm (marked *) are provided with an oil hole on the stud head only. Other models are provided with one oil hole each on the head, outside surface and end surface of the stud.

2. Shield type models with a stud diameter d_1 of 5 mm or less and the sealed type models are provided with prepacked grease. Other models are not provided with prepacked grease. Perform proper lubrication for use.

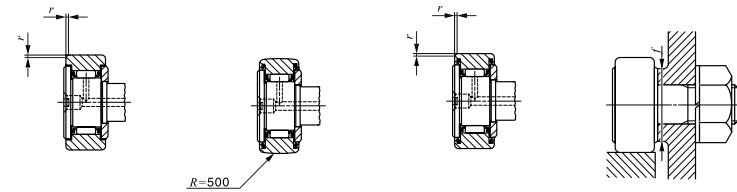

CF

CF...UUR

CF...UU

Boundary dimensions mm										Mounting dimension f Min. mm	Maximum tightening torque N·m	Basic dynamic load rating N	Basic static load rating N	Maximum allowable static load N
G_1	B	B_1	B_2	B_3	C_1	g_1	g_2	$r_{smin}^{(*)}$	(¹)					
5	8	17	9	—	0.5	—	—	0.2	6.8	0.34	1 500	1 020	384	
6	9	20	11	—	0.5	—	—	0.3	8.3	0.78	2 070	1 590	834	
7.5	10	23	13	—	0.5	*3.1	—	0.3	9.3	1.6	2 520	2 140	1 260	
8	12.2max	28.2max	16	—	0.6	*4	—	0.3	11	2.7	3 660	3 650	1 950	
10	12.2max	32.2max	20	—	0.6	*4	—	0.3	13	6.5	4 250	4 740	4 620	
10	12.2max	32.2max	20	—	0.6	*4	—	0.3	13	7.1	4 250	4 740	4 620	
12	13.2max	36.2max	23	—	0.6	*4	—	0.3	16	13.8	5 430	6 890	6 890	
12	13.2max	36.2max	23	—	0.6	*4	—	0.3	16	14.7	5 430	6 890	6 890	
12	13.2max	36.2max	23	—	0.6	*4	—	0.3	16	13.8	5 430	6 890	6 890	
12	13.2max	36.2max	23	—	0.6	*4	—	0.3	16	14.7	5 430	6 890	6 890	
13	15.2max	40.2max	25	6	0.6	6	3	0.6	21	21.9	7 910	9 790	9 790	
13	15.2max	40.2max	25	6	0.6	6	3	0.6	21	21.9	7 910	9 790	9 790	
17	19.6max	52.1max	32.5	8	0.8	6	3	0.6	26	58.5	12 000	18 300	18 300	
19	21.6max	58.1max	36.5	8	0.8	6	3	1	29	86.2	14 800	25 200	25 200	
21	25.6max	66.1max	40.5	9	0.8	8	4	1	34	119	20 700	34 600	34 600	
21	25.6max	66.1max	40.5	9	0.8	8	4	1	34	119	20 700	34 600	34 600	
25	30.6max	80.1max	49.5	11	0.8	8	4	1	40	215	30 500	52 600	52 000	
25	30.6max	80.1max	49.5	11	0.8	8	4	1	40	215	30 500	52 600	52 000	
32	37 max	100 max	63	15	1	8	4	1	49	438	45 400	85 100	85 100	
32	37 max	100 max	63	15	1	8	4	1	49	438	45 400	85 100	85 100	
32	37 max	100 max	63	15	1	8	4	1	49	438	45 400	85 100	85 100	

1N=0.102kgf=0.2248lbs.

1mm=0.03937inch

I
CF
NUCF
CFS
CFR

CAM FOLLOWERS

Standard Type Cam Followers **Full Complement Type/With Hexagon Hole**

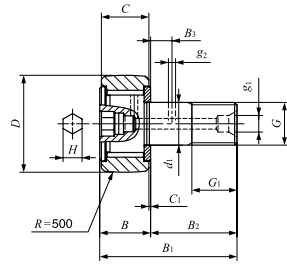

CF...VBR

Stud dia. 6–30 mm

Stud dia. mm	Identification number				Mass (Ref.) g	D	C	d ₁
	Shield type		Sealed type					
	With crowned outer ring	With cylindrical outer ring	With crowned outer ring	With cylindrical outer ring				
6	CF 6 VBR	CF 6 VB	CF 6 VBUUR	CF 6 VBUU	19	16	11	6
8	CF 8 VBR	CF 8 VB	CF 8 VBUUR	CF 8 VBUU	29	19	11	8
	CF 8 VBRM	CF 8 VBM	CF 8 VBUURM	CF 8 VBUUM	29	19	11	8
10	CF 10 VBR	CF 10 VB	CF 10 VBUUR	CF 10 VBUU	46	22	12	10
	CF 10 VBRM	CF 10 VBM	CF 10 VBUURM	CF 10 VBUUM	46	22	12	10
	CF 10-1 VBR	CF 10-1 VB	CF 10-1 VBUUR	CF 10-1 VBUU	61	26	12	10
	CF 10-1 VBRM	CF 10-1 VBM	CF 10-1 VBUURM	CF 10-1 VBUUM	61	26	12	10
12	CF 12 VBR	CF 12 VB	CF 12 VBUUR	CF 12 VBUU	97	30	14	12
	CF 12-1 VBR	CF 12-1 VB	CF 12-1 VBUUR	CF 12-1 VBUU	107	32	14	12
16	CF 16 VBR	CF 16 VB	CF 16 VBUUR	CF 16 VBUU	173	35	18	16
18	CF 18 VBR	CF 18 VB	CF 18 VBUUR	CF 18 VBUU	255	40	20	18
20	CF 20 VBR	CF 20 VB	CF 20 VBUUR	CF 20 VBUU	465	52	24	20
	CF 20-1 VBR	CF 20-1 VB	CF 20-1 VBUUR	CF 20-1 VBUU	390	47	24	20
24	CF 24 VBR	CF 24 VB	CF 24 VBUUR	CF 24 VBUU	820	62	29	24
	CF 24-1 VBR	CF 24-1 VB	CF 24-1 VBUUR	CF 24-1 VBUU	1 140	72	29	24
30	CF 30 VBR	CF 30 VB	CF 30 VBUUR	CF 30 VBUU	1 870	80	35	30
	CF 30-1 VBR	CF 30-1 VB	CF 30-1 VBUUR	CF 30-1 VBUU	2 030	85	35	30
	CF 30-2 VBR	CF 30-2 VB	CF 30-2 VBUUR	CF 30-2 VBUU	2 220	90	35	30

Note(1) Minimum allowable value of chamfer dimension r

Remarks1. Models with a stud diameter d₁ of 10 mm or less have an oil hole (re-greasing fitting) at the head. Other models are provided with an oil hole (grease nipple) at the head and an oil hole each on the outside surface and end surface of the stud.

2. Provided with prepacked grease.

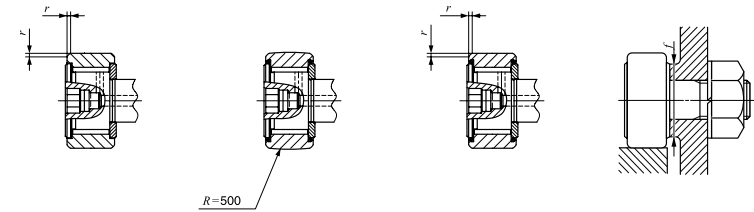

CF...VB

CF...VBUUR

CF...VBUU

Boundary dimensions mm											Mounting dimension f Min. mm	Maximum tightening torque N-m	Basic dynamic load rating C N	Basic static load rating C ₀ N	Maximum allowable static load N
G	G ₁	B max	B ₁ max	B ₂	B ₃	C ₁	g ₁	g ₂	H	r _{smin} ⁽¹⁾					
M 6×1	8	12.2	28.2	16	—	0.6	—	—	3	0.3	11	2.7	6 980	8 500	1 950
M 8×1.25	10	12.2	32.2	20	—	0.6	—	—	4	0.3	13	6.5	8 170	11 200	4 620
M 8×1	10	12.2	32.2	20	—	0.6	—	—	4	0.3	13	7.1	8 170	11 200	4 620
M10×1.25	12	13.2	36.2	23	—	0.6	—	—	4	0.3	16	13.8	9 570	14 500	8 650
M10×1	12	13.2	36.2	23	—	0.6	—	—	4	0.3	16	14.7	9 570	14 500	8 650
M10×1.25	12	13.2	36.2	23	—	0.6	—	—	4	0.3	16	13.8	9 570	14 500	8 650
M10×1	12	13.2	36.2	23	—	0.6	—	—	4	0.3	16	14.7	9 570	14 500	8 650
M12×1.5	13	15.2	40.2	25	6	0.6	6	3	6	0.6	21	21.9	13 500	19 700	13 200
M12×1.5	13	15.2	40.2	25	6	0.6	6	3	6	0.6	21	21.9	13 500	19 700	13 200
M16×1.5	17	19.6	52.1	32.5	8	0.8	6	3	6	0.6	26	58.5	20 700	37 600	23 200
M18×1.5	19	21.6	58.1	36.5	8	0.8	6	3	8	1	29	86.2	25 300	51 300	31 100
M20×1.5	21	25.6	66.1	40.5	9	0.8	8	4	8	1	34	119	33 200	64 500	37 500
M20×1.5	21	25.6	66.1	40.5	9	0.8	8	4	8	1	34	119	33 200	64 500	37 500
M24×1.5	25	30.6	80.1	49.5	11	0.8	8	4	12	1	40	215	46 600	92 000	52 000
M24×1.5	25	30.6	80.1	49.5	11	0.8	8	4	12	1	40	215	46 600	92 000	52 000
M30×1.5	32	37	100	63	15	1	8	4	17	1	49	438	67 700	144 000	85 900
M30×1.5	32	37	100	63	15	1	8	4	17	1	49	438	67 700	144 000	85 900
M30×1.5	32	37	100	63	15	1	8	4	17	1	49	438	67 700	144 000	85 900

1N=0.102kgf=0.2248lbs.
1mm=0.03937inch

CAM FOLLOWERS

Standard Type Cam Followers Full Complement Type/With Screwdriver Slot

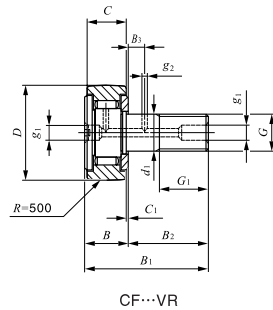

Stud dia. 6–30 mm

Stud dia. mm	Identification number				Mass (Ref.) g	D	C	d ₁
	Shield type		Sealed type					
	With crowned outer ring	With cylindrical outer ring	With crowned outer ring	With cylindrical outer ring				
6	CF 6 VR	CF 6 V	CF 6 VUUR	CF 6 VUU	19	16	11	
	CF 8 VR	CF 8 V	CF 8 VUUR	CF 8 VUU				
8	CF 8 VRM	CF 8 VM	CF 8 VUURM	CF 8 VUUM	29	19	11	
	CF 10 VR	CF 10 V	CF 10 VUUR	CF 10 VUU	46	22	12	10
10	CF 10 VRM	CF 10 VM	CF 10 VUURM	CF 10 VUUM	46	22	12	10
	CF 10-1 VR	CF 10-1 V	CF 10-1 VUUR	CF 10-1 VUU	61	26	12	10
	CF 10-1 VRM	CF 10-1 VM	CF 10-1 VUURM	CF 10-1 VUUM	61	26	12	10
12	CF 12 VR	CF 12 V	CF 12 VUUR	CF 12 VUU	97	30	14	12
	CF 12-1 VR	CF 12-1 V	CF 12-1 VUUR	CF 12-1 VUU	107	32	14	12
16	CF 16 VR	CF 16 V	CF 16 VUUR	CF 16 VUU	173	35	18	16
18	CF 18 VR	CF 18 V	CF 18 VUUR	CF 18 VUU	255	40	20	18
20	CF 20 VR	CF 20 V	CF 20 VUUR	CF 20 VUU	465	52	24	20
	CF 20-1 VR	CF 20-1 V	CF 20-1 VUUR	CF 20-1 VUU	390	47	24	20
24	CF 24 VR	CF 24 V	CF 24 VUUR	CF 24 VUU	820	62	29	24
	CF 24-1 VR	CF 24-1 V	CF 24-1 VUUR	CF 24-1 VUU	1 140	72	29	24
30	CF 30 VR	CF 30 V	CF 30 VUUR	CF 30 VUU	1 870	80	35	30
	CF 30-1 VR	CF 30-1 V	CF 30-1 VUUR	CF 30-1 VUU	2 030	85	35	30
	CF 30-2 VR	CF 30-2 V	CF 30-2 VUUR	CF 30-2 VUU	2 220	90	35	30

Note(1) Minimum allowable value of chamfer dimension r

Remarks 1. Models with a stud diameter d₁ of 10 mm or less (marked *) are provided with an oil hole on the stud head only. Other models are provided with one oil hole each on the head, outside surface and end surface of the stud.

2. Provided with prepacked grease.

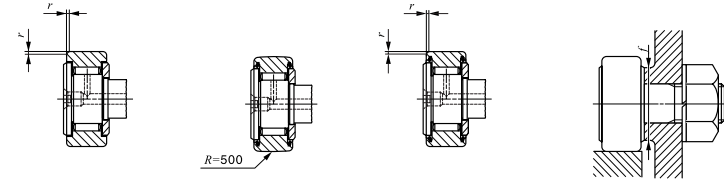

CF...V

CF...VUUR

CF...VUU

Boundary dimensions mm											Mounting dimension f Min. mm	Maximum tightening torque N·m	Basic dynamic load rating C N	Basic static load rating C ₀ N	Maximum allowable static load N
G	G ₁	B max	B ₁ max	B ₂	B ₃	C ₁	g ₁	g ₂	r _{smin} ⁽¹⁾	r					
M 6×1		12.2	28.2	16	—	0.6	—	0.3	11	2.7	980	500	1 950		
M 8×1.25	10	12.2	32.2	20	—	0.6	—	0.3	13	6.5	8 170	11 200	4 620		
M 8×1	10	12.2	32.2	20	—	0.6	—	0.3	13	7.1	8 170	11 200	4 620		
M10×1.25	12	13.2	36.2	23	—	0.6	—	0.3	16	13.8	9 570	14 500	8 650		
M10×1	12	13.2	36.2	23	—	0.6	—	0.3	16	14.7	9 570	14 500	8 650		
M10×1.25	12	13.2	36.2	23	—	0.6	—	0.3	16	13.8	9 570	14 500	8 650		
M10×1	12	13.2	36.2	23	—	0.6	—	0.3	16	14.7	9 570	14 500	8 650		
M12×1.5	13	15.2	40.2	25	6	0.6	3	0.6	21	21.9	13 500	19 700	13 200		
M12×1.5	13	15.2	40.2	25	6	0.6	3	0.6	21	21.9	13 500	19 700	13 200		
M16×1.5	17	19.6	52.1	32.5	8	0.8	3	0.6	26	58.5	20 700	37 600	23 200		
M18×1.5	19	21.6	58.1	36.5	8	0.8	3	1	29	86.2	25 300	51 300	31 100		
M20×1.5	21	25.6	66.1	40.5	9	0.8	4	1	34	119	33 200	64 500	37 500		
M20×1.5	21	25.6	66.1	40.5	9	0.8	4	1	34	119	33 200	64 500	37 500		
M24×1.5	25	30.6	80.1	49.5	11	0.8	4	1	40	215	46 600	92 000	52 000		
M24×1.5	25	30.6	80.1	49.5	11	0.8	4	1	40	215	46 600	92 000	52 000		
M30×1.5	32	37	100	63	15	1	4	1	49	438	67 700	144 000	85 900		
M30×1.5	32	37	100	63	15	1	4	1	49	438	67 700	144 000	85 900		
M30×1.5	32	37	100	63	15	1	4	1	49	438	67 700	144 000	85 900		

1N=0.102kgf=0.2248lbs.
1mm=0.03937inch

CAM FOLLOWERS

Stainless Steel Made Cam Followers **With Cage/With Hexagon Hole**

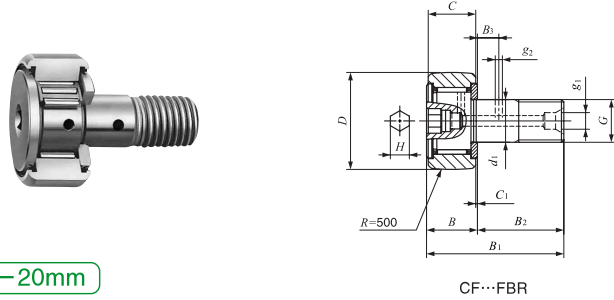

Stud dia. 3–20mm

Stud dia. mm	Identification number				Mass (Ref.) g	D	C	d ₁	G	G ₁
	Shield type		Sealed type							
	With crowned outer ring	With cylindrical outer ring	With crowned outer ring	With cylindrical outer ring						
3	CF 3 FBR	CF 3 FB	CF 3 FBUUR	CF 3 FBUU	4.3	10	7	3	M 3×0.5	5
4	CF 4 FBR	CF 4 FB	CF 4 FBUUR	CF 4 FBUU	7.4	12	8	4	M 4×0.7	6
5	CF 5 FBR	CF 5 FB	CF 5 FBUUR	CF 5 FBUU	10.3	13	9	5	M 5×0.8	7.5
6	CF 6 FBR	—	CF 6 FBUUR	—	18.5	16	11	6	M 6×1	8
8	CF 8 FBR	—	CF 8 FBUUR	—	28.5	19	11	8	M 8×1.25	10
10	CF 10 FBR	—	CF 10 FBUUR	—	45	22	12	10	M10×1.25	12
12	CF 12 FBR	—	CF 12 FBUUR	—	95	30	14	12	M12×1.5	13
16	CF 16 FBR	—	CF 16 FBUUR	—	170	35	18	16	M16×1.5	17
18	CF 18 FBR	—	CF 18 FBUUR	—	250	40	20	18	M18×1.5	19
20	CF 20 FBR	—	CF 20 FBUUR	—	460	52	24	20	M20×1.5	21

Note⁽¹⁾ Minimum allowable value of chamfer dimension r
 Remarks1. Models with a stud diameter d_1 of 4 mm or less have no oil hole. For models with a stud dia. 5 to 10 mm, oil hole (re-greasing fitting) is provided at the head. Other models are provided with an oil hole (grease nipple) at the head and an oil hole each on the outside surface and end surface of the stud.
 2. Shield type models with a stud diameter d_1 of 10 mm or less and the sealed type models are provided with prepacked grease. Other models are not provided with prepacked grease. Perform proper lubrication for use.

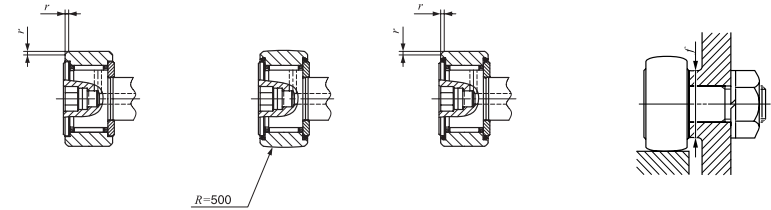

Boundary dimensions mm										Mounting dimension f Min. mm	Maximum tightening torque N·m	Basic dynamic load rating C N	Basic static load rating C ₀ N	Maximum allowable static load N
B	B ₁	B ₂	B ₃	C ₁	g ₁	g ₂	H	r _{s min} ⁽¹⁾						
8	17	9	—	0.5	—	—	2	0.2	6.8	0.34	1 200	813	384	
9	20	11	—	0.5	—	—	2.5	0.3	8.3	0.78	1 650	1 270	834	
10	23	13	—	0.5	—	—	3	0.3	9.3	1.6	1 930	1 730	1 260	
12.2 max	28.2 max	16	—	0.6	—	—	3	—	11	2.7	2 930	2 920	1 950	
12.2 max	32.2 max	20	—	0.6	—	—	4	—	13	6.5	3 400	3 790	3 790	
13.2 max	36.2 max	23	—	0.6	—	—	5	—	16	13.8	4 340	5 510	5 510	
15.2 max	40.2 max	25	6	0.6	6	3	6	—	21	21.9	6 330	7 830	7 830	
19.6 max	52.1 max	32.5	8	0.8	6	3	6	—	26	58.5	9 620	14 700	14 700	
21.6 max	58.1 max	36.5	8	0.8	6	3	8	—	29	86.2	11 800	20 200	20 200	
25.6 max	66.1 max	40.5	9	0.8	8	4	8	—	34	119	16 500	27 700	27 700	

I
 CF
 NUCF
 CFS
 CR

CAM FOLLOWERS

Solid Eccentric Stud Type Cam Followers With Cage/With Hexagon Hole

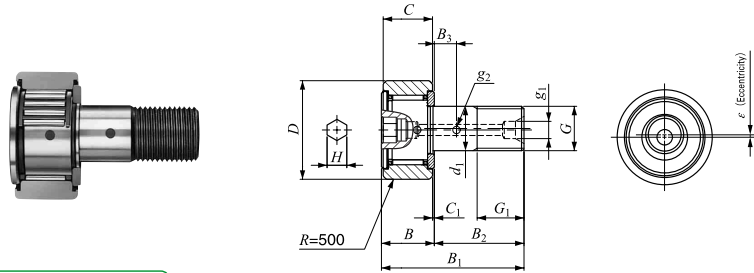

Stud dia. 6–18 mm

CFES...BR

Stud dia. mm	Identification number				Mass (Ref.) g	D	C	d ₁
	Shield type		Sealed type					
	With crowned outer ring	With cylindrical outer ring	With crowned outer ring	With cylindrical outer ring				
6	CFES 6 BR	CFES 6 B	CFES 6 BUUR	CFES 6 BUU	18.5	16	11	6
8	CFES 8 BR	CFES 8 B	CFES 8 BUUR	CFES 8 BUU	28.5	19	11	8
10	CFES 10 BR	CFES 10 B	CFES 10 BUUR	CFES 10 BUU	45	22	12	10
	CFES 10-1 BR	CFES 10-1 B	CFES 10-1 BUUR	CFES 10-1 BUU	60	26	12	10
12	CFES 12 BR	CFES 12 B	CFES 12 BUUR	CFES 12 BUU	95	30	14	12
	CFES 12-1 BR	CFES 12-1 B	CFES 12-1 BUUR	CFES 12-1 BUU	105	32	14	12
16	CFES 16 BR	CFES 16 B	CFES 16 BUUR	CFES 16 BUU	170	35	18	16
18	CFES 18 BR	CFES 18 B	CFES 18 BUUR	CFES 18 BUU	250	40	20	18

Note(1) Minimum allowable value of chamfer dimension r
 Remarks 1. Models with a stud diameter d_1 of 10 mm or less have an oil hole (re-greasing fitting) at the head. Other models are provided with an oil hole (grease nipple) at the head and an oil hole each on the outside surface and end surface of the stud.
 2. Shield type models with a stud diameter d_1 of 10 mm or less and the sealed type models are provided with prepacked grease. Other models are not provided with prepacked grease. Perform proper lubrication for use.

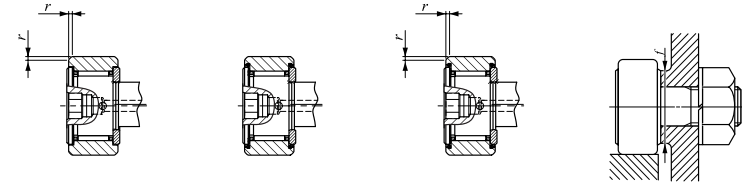

Boundary dimensions mm														Eccentricity ϵ	Mounting dimension f Min. mm	Maximum tightening torque N·m	Basic dynamic load rating C N	Basic static load rating C ₀ N	Maximum allowable static load N
G	G ₁	B _{max}	B _{1 max}	B ₂	B ₃	C ₁	g ₁	g ₂	H	r _{s min} ⁽¹⁾									
M 6×1		12.2	28.2	16		0.6	—	3	0.3	0.25	11	2.7	3 660	3 6 0	1 9 0				
M 8×1.25	10	12.2	32.2	20		0.6	—	4	0.3	0.25	13	6.5	4 250	4 740	4 670				
M10×1.25	12	13.2	36.2	23		0.6	—	4	0.3	0.3	16	13.8	5 430	6 890	6 890				
M10×1.25	12	13.2	36.2	23		0.6	—	4	0.3	0.3	16	13.8	5 430	6 890	6 890				
M12×1.5	13	15.2	40.2	25	6	0.6	6	3	6	0.6	21	21.9	7 910	9 790	9 790				
M12×1.5	13	15.2	40.2	25	6	0.6	6	3	6	0.6	21	21.9	7 910	9 790	9 790				
M16×1.5	17	19.6	52.1	32.	8	0.8	6	3	6	0.6	26	58.5	12 000	18 300	18 300				
M18×1.5	19	21.6	58.1	36.	8	0.8	6	3	8	1	29	86.2	14 800	25 200	25 200				

1N=0.102kgf=0.2248lbs.
 1mm=0.03937inch

CAM FOLLOWERS

Solid Eccentric Stud Type Cam Followers With Cage/With Screwdriver Slot

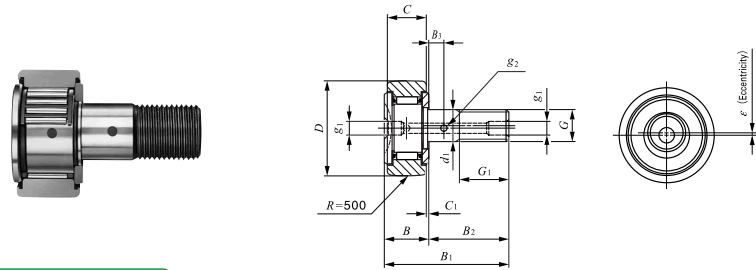

Stud dia. 6–18 mm

CFES...R

Stud dia. mm	Identification number				Mass (Ref.) g	D	C	d ₁
	Shield type		Sealed type					
	With crowned outer ring	With cylindrical outer ring	With crowned outer ring	With cylindrical outer ring				
6	CFES 6 R	CFES 6	CFES 6 UUR	CFES 6 UU	18.5	16	11	6
8	CFES 8 R	CFES 8	CFES 8 UUR	CFES 8 UU	28.5	19	11	8
10	CFES 10 R	CFES 10	CFES 10 UUR	CFES 10 UU	45	22	12	10
	CFES 10-1 R	CFES 10-1	CFES 10-1 UUR	CFES 10-1 UU	60	26	12	10
12	CFES 12 R	CFES 12	CFES 12 UUR	CFES 12 UU	95	30	14	12
	CFES 12-1 R	CFES 12-1	CFES 12-1 UUR	CFES 12-1 UU	105	32	14	12
16	CFES 16 R	CFES 16	CFES 16 UUR	CFES 16 UU	170	35	18	16
18	CFES 18 R	CFES 18	CFES 18 UUR	CFES 18 UU	250	40	20	18

Note(1) Minimum allowable value of chamfer dimension *r*
 Remarks 1. Models with a stud diameter *d*₁ of 10 mm or less (marked *) are provided with an oil hole on the stud head only. Other models are provided with one oil hole each on the head, outside surface and end surface of the stud.
 2. Sealed type models are provided with prepacked grease. Other models are not provided with prepacked grease. Perform proper lubrication for use.

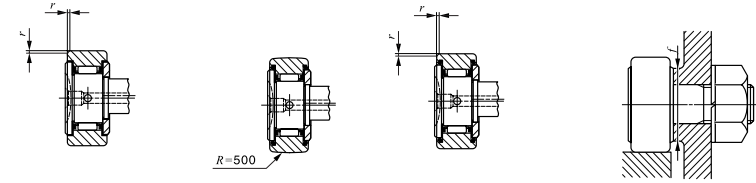

CFES

CFES...UUR

CFES...UU

Boundary dimensions mm	mm										Eccentricity <i>f</i> Min. mm	Maximum tightening torque N·m	Basic dynamic load rating C N	Basic static load rating C ₀ N	Maximum allowable static load N
	<i>G</i>	<i>G</i> ₁	<i>B</i> _{max}	<i>B</i> _{1max}	<i>B</i> ₂	<i>B</i> ₃	<i>C</i> ₁	<i>g</i> ₁	<i>g</i> ₂	<i>r</i> _{smin} ⁽¹⁾					
M 6×1	8	12.2	28.2	16	—	0.6	*4	—	0.3	0.25	11	2.7	3 660	3 650	1 980
M 8×1.25	10	12.2	32.2	20	—	0.6	*4	—	0.3	0.25	13	6.5	4 250	4 740	4 670
M10×1.25	12	13.2	36.2	23	—	0.6	*4	—	0.3	0.3	16	13.8	5 430	6 890	6 890
M10×1.25	12	13.2	36.2	23	—	0.6	*4	—	0.3	0.3	16	13.8	5 430	6 890	6 890
M12×1.5	13	15.2	40.2	25	6	0.6	6	3	0.6	0.4	21	21.9	7 910	9 790	9 790
M12×1.5	13	15.2	40.2	25	6	0.6	6	3	0.6	0.4	21	21.9	7 910	9 790	9 790
M16×1.5	17	19.6	52.1	32.5	8	0.8	6	3	0.6	0.5	26	58.5	12 000	18 300	18 300
M18×1.5	19	21.6	58.1	36.5	8	0.8	6	3	1	0.6	29	86.2	14 800	25 200	25 200

1N=0.102kgf=0.2248lbs.
 1mm=0.03937inch

I

CF
 NUCF
 CFS
 CR

CAM FOLLOWERS

Eccentric Type Cam Followers With Cage/With Hexagon Hole

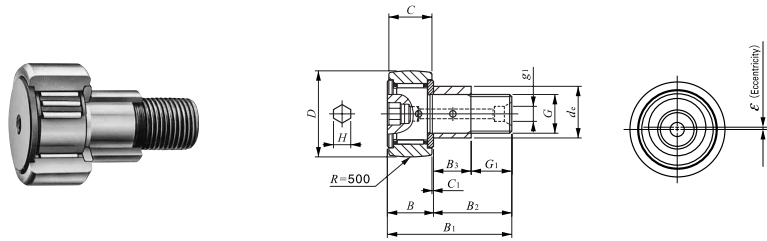

Outside diameter of eccentric collar 9–41 mm

CFE...BR

Outside diameter of eccentric collar mm	Identification number				Mass (Ref.) g	D	C	d _e
	Shield type		Sealed type					
	With crowned outer ring	With cylindrical outer ring	With crowned outer ring	With cylindrical outer ring				
9	CFE 6 BR	CFE 6 B	CFE 6 BUUR	CFE 6 BUU	20.5	16	11	
11	CFE 8 BR	CFE 8 B	CFE 8 BUUR	CFE 8 BUU	32	19	11	11
13	CFE 10 BR	CFE 10 B	CFE 10 BUUR	CFE 10 BUU	49.5	22	12	13
	CFE 10-1 BR	CFE 10-1 B	CFE 10-1 BUUR	CFE 10-1 BUU	65	26	12	13
16	CFE 12 BR	CFE 12 B	CFE 12 BUUR	CFE 12 BUU	105	30	14	16
	CFE 12-1 BR	CFE 12-1 B	CFE 12-1 BUUR	CFE 12-1 BUU	115	32	14	16
22	CFE 16 BR	CFE 16 B	CFE 16 BUUR	CFE 16 BUU	190	35	18	22
24	CFE 18 BR	CFE 18 B	CFE 18 BUUR	CFE 18 BUU	280	40	20	24
27	CFE 20 BR	CFE 20 B	CFE 20 BUUR	CFE 20 BUU	500	52	24	27
	CFE 20-1 BR	CFE 20-1 B	CFE 20-1 BUUR	CFE 20-1 BUU	425	47	24	27
33	CFE 24 BR	CFE 24 B	CFE 24 BUUR	CFE 24 BUU	895	62	29	33
	CFE 24-1 BR	CFE 24-1 B	CFE 24-1 BUUR	CFE 24-1 BUU	1 220	72	29	33
41	CFE 30 BR	CFE 30 B	CFE 30 BUUR	CFE 30 BUU	2 030	80	35	41
	CFE 30-1 BR	CFE 30-1 B	CFE 30-1 BUUR	CFE 30-1 BUU	2 190	85	35	41
	CFE 30-2 BR	CFE 30-2 B	CFE 30-2 BUUR	CFE 30-2 BUU	2 380	90	35	41

Note(1) Minimum allowable value of chamfer dimension r

Remarks 1. Models with a thread diameter G of 10 mm or less have an oil hole (re-greasing fitting) at the head. Other models are provided with an oil hole (grease nipple) at the head and an oil hole on the end surface of the stud.

2. Shield type models with a stud thread diameter G of 10 mm or less and the sealed type models are provided with prepacked grease. Other models are not provided with prepacked grease. Perform proper lubrication for use.

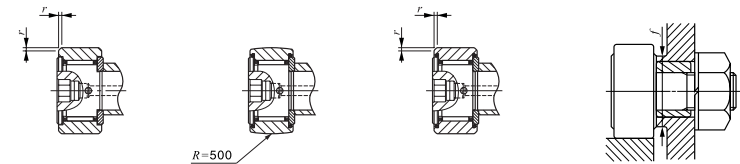

CFE...B

CFE...BUUR

CFE...BUU

Boundary dimensions mm	CFE...B													CFE...BUUR			CFE...BUU		
	G	B ₃	B _{max}	B _{1max}	B ₂	C ₁	g ₁	G ₁	H	r _{smin} ⁽¹⁾	Eccentricity ε	Mounting dimension f Min. mm	Maximum tightening torque N·m	Basic dynamic load rating C N	Basic static load rating C ₀ N	Maximum allowable static load N			
M 6×1	7.5	12.2	28.2	16	0.6		.5	3	0.3	0.	11	2.7	3 6 0	3 650	1 950				
M 8×1.25	9.5	12.2	32.2	20	0.6		10.5	4	0.3	0.	13	6.5	4 250	4 740	4 620				
M10×1.25	10.5	13.2	36.2	23	0.6		12.5	4	0.3	0.	16	13.8	5 430	6 890	6 890				
M10×1.25	10.5	13.2	36.2	23	0.6		12.5	4	0.3	0.	16	13.8	5 430	6 890	6 890				
M12×1.5	11.5	15.2	40.2	25	0.6		13.5	6	0.6	0.	21	21.9	7 910	9 790	9 790				
M12×1.5	11.5	15.2	40.2	25	0.6		13.5	6	0.6	0.	21	21.9	7 910	9 790	9 790				
M16×1.5	15.5	19.6	52.1	32.5	0.8		17	6	0.6	0.	26	58.5	12 000	18 300	18 300				
M18×1.5	17.5	21.6	58.1	36.5	0.8		19	8	1	0.	29	86.2	14 800	25 200	25 200				
M20×1.5	19.5	25.6	66.1	40.5	0.8		21	8	1	0.	34	119	20 700	34 600	34 600				
M20×1.5	19.5	25.6	66.1	40.5	0.8		21	8	1	0.	34	119	20 700	34 600	34 600				
M24×1.5	25.5	30.6	80.1	49.5	0.8		24	12	1	0.	40	215	30 500	52 600	52 000				
M24×1.5	25.5	30.6	80.1	49.5	0.8		24	12	1	0.	40	215	30 500	52 600	52 000				
M30×1.5	32.5	37	100	63	1		30.5	17	1	1.5	49	438	45 400	85 100	85 100				
M30×1.5	32.5	37	100	63	1		30.5	17	1	1.5	49	438	45 400	85 100	85 100				
M30×1.5	32.5	37	100	63	1		30.5	17	1	1.5	49	438	45 400	85 100	85 100				

I
CF
NUCF
CFS
CR

CAM FOLLOWERS

Eccentric Type Cam Followers With Cage/With Screwdriver Slot

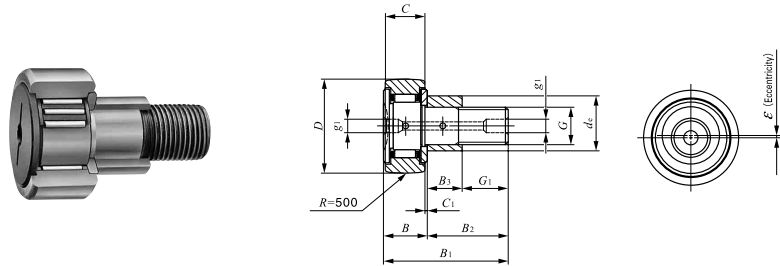

Outside diameter of eccentric collar 9–41 mm

CFE...R

Outside diameter of eccentric collar mm	Identification number				Mass (Ref.) g	D	C	d _c
	Shield type		Sealed type					
	With crowned outer ring	With cylindrical outer ring	With crowned outer ring	With cylindrical outer ring				
9	CFE 6 R	CFE 6	CFE 6 UUR	CFE 6 UU	20.5	16	11	
11	CFE 8 R	CFE 8	CFE 8 UUR	CFE 8 UU	32	19	11	11
13	CFE 10 R	CFE 10	CFE 10 UUR	CFE 10 UU	49.5	22	12	13
	CFE 10-1 R	CFE 10-1	CFE 10-1 UUR	CFE 10-1 UU	65	26	12	13
16	CFE 12 R	CFE 12	CFE 12 UUR	CFE 12 UU	105	30	14	16
	CFE 12-1 R	CFE 12-1	CFE 12-1 UUR	CFE 12-1 UU	115	32	14	16
22	CFE 16 R	CFE 16	CFE 16 UUR	CFE 16 UU	190	35	18	22
24	CFE 18 R	CFE 18	CFE 18 UUR	CFE 18 UU	280	40	20	24
27	CFE 20 R	CFE 20	CFE 20 UUR	CFE 20 UU	500	52	24	27
	CFE 20-1 R	CFE 20-1	CFE 20-1 UUR	CFE 20-1 UU	425	47	24	27
33	CFE 24 R	CFE 24	CFE 24 UUR	CFE 24 UU	895	62	29	33
	CFE 24-1 R	CFE 24-1	CFE 24-1 UUR	CFE 24-1 UU	1 220	72	29	33
41	CFE 30 R	CFE 30	CFE 30 UUR	CFE 30 UU	2 030	80	35	41
	CFE 30-1 R	CFE 30-1	CFE 30-1 UUR	CFE 30-1 UU	2 190	85	35	41
	CFE 30-2 R	CFE 30-2	CFE 30-2 UUR	CFE 30-2 UU	2 380	90	35	41

Note⁽¹⁾ Minimum allowable value of chamfer dimension *r*

Remarks 1. Models with a stud thread diameter *G* of 10 mm or less (marked *) are provided with an oil hole on the stud head only. Other models are provided with one oil hole each on the head and end surface of the stud.

2. Sealed type models are provided with prepacked grease. Other models are not provided with prepacked grease. Perform proper lubrication for use.

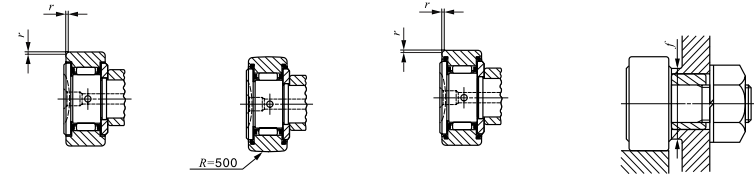

CFE

CFE...UUR

CFE...UU

Boundary dimensions mm	CFE										CFE...UUR			CFE...UU		
	<i>G</i>	<i>B</i> ₃	<i>B</i> _{max}	<i>B</i> _{1 max}	<i>B</i> ₂	<i>C</i> ₁	<i>g</i> ₁	<i>G</i> ₁	<i>r</i> _{smin} ⁽¹⁾	Eccentricity <i>ε</i>	Mounting dimension <i>f</i> Min. mm	Maximum tightening torque N·m	Basic dynamic load rating <i>C</i> N	Basic static load rating <i>C</i> ₀ N	Maximum allowable static load N	
M 6×1	7.5	12.2	28.2	16	0.6	*4	.5	0.3	0.	11	2.7	3 6 0	3 650	1 950		
M 8×1.25	9.5	12.2	32.2	20	0.6	*4	10.5	0.3	0.	13	6.5	4 250	4 740	4 620		
M10×1.25	10.5	13.2	36.2	23	0.6	*4	12.5	0.3	0.	16	13.8	5 430	6 890	6 890		
M10×1.25	10.5	13.2	36.2	23	0.6	*4	12.5	0.3	0.	16	13.8	5 430	6 890	6 890		
M12×1.5	11.5	15.2	40.2	25	0.6	6	13.5	0.6	0.	21	21.9	7 910	9 790	9 790		
M12×1.5	11.5	15.2	40.2	25	0.6	6	13.5	0.6	0.	21	21.9	7 910	9 790	9 790		
M16×1.5	15.5	19.6	52.1	32.5	0.8	6	17	0.6	0.	26	58.5	12 000	18 300	18 300		
M18×1.5	17.5	21.6	58.1	36.5	0.8	6	19	1	0.	29	86.2	14 800	25 200	25 200		
M20×1.5	19.5	25.6	66.1	40.5	0.8	8	21	1	0.	34	119	20 700	34 600	34 600		
M20×1.5	19.5	25.6	66.1	40.5	0.8	8	21	1	0.	34	119	20 700	34 600	34 600		
M24×1.5	25.5	30.6	80.1	49.5	0.8	8	24	1	0.	40	215	30 500	52 600	52 000		
M24×1.5	25.5	30.6	80.1	49.5	0.8	8	24	1	0.	40	215	30 500	52 600	52 000		
M30×1.5	32.5	37	100	63	1	8	30.5	1	1.5	49	438	45 400	85 100	85 100		
M30×1.5	32.5	37	100	63	1	8	30.5	1	1.5	49	438	45 400	85 100	85 100		
M30×1.5	32.5	37	100	63	1	8	30.5	1	1.5	49	438	45 400	85 100	85 100		

1N=0.102kgf=0.2248lbs.
1mm=0.03937inch

I
CF
NUCF
CFS
CR

CAM FOLLOWERS

Eccentric Type Cam Followers Full Complement Type/With Hexagon Hole

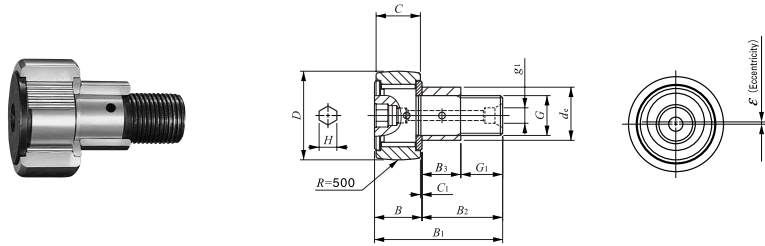

Outside diameter of eccentric collar 9–41 mm

CFE...VBR

Outside diameter of eccentric collar mm	Identification number				Mass (Ref.) g	D	C	d _e
	Shield type		Sealed type					
	With crowned outer ring	With cylindrical outer ring	With crowned outer ring	With cylindrical outer ring				
9	CFE 6 VBR	CFE 6 VB	CFE 6 VBUUR	CFE 6 VBUU	21	16	11	
11	CFE 8 VBR	CFE 8 VB	CFE 8 VBUUR	CFE 8 VBUU	32.5	19	11	11
13	CFE 10 VBR	CFE 10 VB	CFE 10 VBUUR	CFE 10 VBUU	50.5	22	12	13
	CFE 10-1 VBR	CFE 10-1 VB	CFE 10-1 VBUUR	CFE 10-1 VBUU	66	26	12	13
16	CFE 12 VBR	CFE 12 VB	CFE 12 VBUUR	CFE 12 VBUU	107	30	14	16
	CFE 12-1 VBR	CFE 12-1 VB	CFE 12-1 VBUUR	CFE 12-1 VBUU	117	32	14	16
22	CFE 16 VBR	CFE 16 VB	CFE 16 VBUUR	CFE 16 VBUU	193	35	18	22
24	CFE 18 VBR	CFE 18 VB	CFE 18 VBUUR	CFE 18 VBUU	285	40	20	24
27	CFE 20 VBR	CFE 20 VB	CFE 20 VBUUR	CFE 20 VBUU	505	52	24	27
	CFE 20-1 VBR	CFE 20-1 VB	CFE 20-1 VBUUR	CFE 20-1 VBUU	430	47	24	27
33	CFE 24 VBR	CFE 24 VB	CFE 24 VBUUR	CFE 24 VBUU	900	62	29	33
	CFE 24-1 VBR	CFE 24-1 VB	CFE 24-1 VBUUR	CFE 24-1 VBUU	1 220	72	29	33
41	CFE 30 VBR	CFE 30 VB	CFE 30 VBUUR	CFE 30 VBUU	2 030	80	35	41
	CFE 30-1 VBR	CFE 30-1 VB	CFE 30-1 VBUUR	CFE 30-1 VBUU	2 190	85	35	41
	CFE 30-2 VBR	CFE 30-2 VB	CFE 30-2 VBUUR	CFE 30-2 VBUU	2 380	90	35	41

Note⁽¹⁾ Minimum allowable value of chamfer dimension *r*

Remarks 1. Models with a thread diameter *G* of 10 mm or less have an oil hole (re-greasing fitting) at the head. Other models are provided with an oil hole (grease nipple) at the head and an oil hole on the end surface of the stud.

2. Provided with prepacked grease.

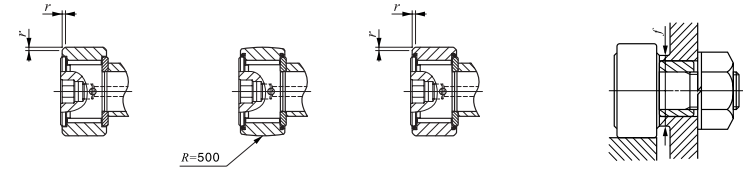

CFE...VB

CFE...VBUUR

CFE...VBUU

Boundary dimensions mm	Boundary dimensions mm														Mounting dimension f Min. mm	Maximum tightening torque N-m	Basic dynamic load rating C N	Basic static load rating C ₀ N	Maximum allowable static load N
	<i>G</i>	<i>B</i> ₃	<i>B</i> _{max}	<i>B</i> _{1 max}	<i>B</i> ₂	<i>C</i> ₁	<i>g</i> ₁	<i>G</i> ₁	<i>H</i>	<i>r</i> _{s min} ⁽¹⁾	Eccentricity <i>e</i>								
M 6×1	7.5	12.2	28.2	16	0.6	.5	3	0.3	0.	11	2.7	0	500	1 950					
M 8×1.25	9.5	12.2	32.2	20	0.6	10.5	4	0.3	0.	13	6.5	170	11 200	4 620					
M10×1.25	10.5	13.2	36.2	23	0.6	12.5	4	0.3	0.	16	13.8	9 570	14 500	8 650					
M10×1.25	10.5	13.2	36.2	23	0.6	12.5	4	0.3	0.	16	13.8	9 570	14 500	8 650					
M12×1.5	11.5	15.2	40.2	25	0.6	13.5	6	0.6	0.	21	21.9	13 500	19 700	13 200					
M12×1.5	11.5	15.2	40.2	25	0.6	13.5	6	0.6	0.	21	21.9	13 500	19 700	13 200					
M16×1.5	15.5	19.6	52.1	32.5	0.8	17	6	0.6	0.	26	58.5	20 700	37 600	23 200					
M18×1.5	17.5	21.6	58.1	36.5	0.8	19	8	1	0.	29	86.2	25 300	51 300	31 100					
M20×1.5	19.5	25.6	66.1	40.5	0.8	21	8	1	0.	34	119	33 200	64 500	37 500					
M20×1.5	19.5	25.6	66.1	40.5	0.8	21	8	1	0.	34	119	33 200	64 500	37 500					
M24×1.5	25.5	30.6	80.1	49.5	0.8	24	12	1	0.	40	215	46 600	92 000	52 000					
M24×1.5	25.5	30.6	80.1	49.5	0.8	24	12	1	0.	40	215	46 600	92 000	52 000					
M30×1.5	32.5	37	100	63	1	30.5	17	1	1.5	49	438	67 700	144 000	85 900					
M30×1.5	32.5	37	100	63	1	30.5	17	1	1.5	49	438	67 700	144 000	85 900					
M30×1.5	32.5	37	100	63	1	30.5	17	1	1.5	49	438	67 700	144 000	85 900					

1N=0.102kgf=0.2248lbs.
1mm=0.03937inch

I
CF
NUCF
CFS
CR

CAM FOLLOWERS

Eccentric Type Cam Followers Full Complement Type/With Screwdriver Slot

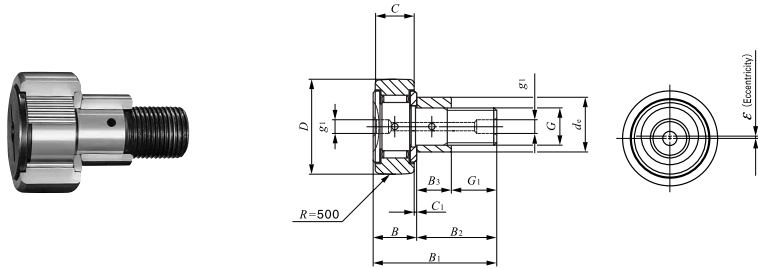

Outside diameter of eccentric collar 9 – 41 mm

CFE...VR

Outside diameter of eccentric collar mm	Identification number				Mass (Ref.) g	D	C	d _c
	Shield type		Sealed type					
	With crowned outer ring	With cylindrical outer ring	With crowned outer ring	With cylindrical outer ring				
9	CFE 6 VR	CFE 6 V	CFE 6 VUUR	CFE 6 VUU	21	16	11	9
11	CFE 8 VR	CFE 8 V	CFE 8 VUUR	CFE 8 VUU	32.5	19	11	11
13	CFE 10 VR	CFE 10 V	CFE 10 VUUR	CFE 10 VUU	50.5	22	12	13
	CFE 10-1 VR	CFE 10-1 V	CFE 10-1 VUUR	CFE 10-1 VUU	66	26	12	13
16	CFE 12 VR	CFE 12 V	CFE 12 VUUR	CFE 12 VUU	107	30	14	16
	CFE 12-1 VR	CFE 12-1 V	CFE 12-1 VUUR	CFE 12-1 VUU	117	32	14	16
22	CFE 16 VR	CFE 16 V	CFE 16 VUUR	CFE 16 VUU	193	35	18	22
24	CFE 18 VR	CFE 18 V	CFE 18 VUUR	CFE 18 VUU	285	40	20	24
27	CFE 20 VR	CFE 20 V	CFE 20 VUUR	CFE 20 VUU	505	52	24	27
	CFE 20-1 VR	CFE 20-1 V	CFE 20-1 VUUR	CFE 20-1 VUU	430	47	24	27
33	CFE 24 VR	CFE 24 V	CFE 24 VUUR	CFE 24 VUU	900	62	29	33
	CFE 24-1 VR	CFE 24-1 V	CFE 24-1 VUUR	CFE 24-1 VUU	1 220	72	29	33
41	CFE 30 VR	CFE 30 V	CFE 30 VUUR	CFE 30 VUU	2 030	80	35	41
	CFE 30-1 VR	CFE 30-1 V	CFE 30-1 VUUR	CFE 30-1 VUU	2 190	85	35	41
	CFE 30-2 VR	CFE 30-2 V	CFE 30-2 VUUR	CFE 30-2 VUU	2 380	90	35	41

Note(1) Minimum allowable value of chamfer dimension r

Remarks1. Models with a stud thread diameter G of 10 mm or less (marked *) are provided with an oil hole on the stud head only. Other models are provided with one oil hole each on the head, and end surface of the stud.

2. Provided with prepacked grease.

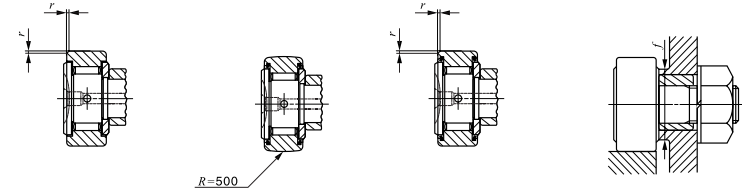

CFE...V

CFE...VUUR

CFE...VUU

Boundary dimensions mm											Mounting dimension f Min. mm	Maximum tightening torque N·m	Basic dynamic load rating C N	Basic static load rating C ₀ N	Maximum allowable static load N
G	B ₃	B max	B ₁ max	B ₂	C ₁	g ₁	G ₁	r _s min ⁽¹⁾	Eccentricity ε						
M 6 × 1	7.5	12.2	28.2	16	0.6	*4	8.5	0.3	0.4	11	2.7	6 980	8 500	1 950	
M 8 × 1.25	9.5	12.2	32.2	20	0.6	*4	10.5	0.3	0.4	13	6.5	8 170	11 200	4 620	
M10 × 1.25	10.5	13.2	36.2	23	0.6	*4	12.5	0.3	0.4	16	13.8	9 570	14 500	8 650	
M10 × 1.25	10.5	13.2	36.2	23	0.6	*4	12.5	0.3	0.4	16	13.8	9 570	14 500	8 650	
M12 × 1.5	11.5	15.2	40.2	25	0.6	6	13.5	0.6	0.8	21	21.9	13 500	19 700	13 200	
M12 × 1.5	11.5	15.2	40.2	25	0.6	6	13.5	0.6	0.8	21	21.9	13 500	19 700	13 200	
M16 × 1.5	15.5	19.6	52.1	32.5	0.8	6	17	0.6	0.8	26	58.5	20 700	37 600	23 200	
M18 × 1.5	17.5	21.6	58.1	36.5	0.8	6	19	1	0.8	29	86.2	25 300	51 300	31 100	
M20 × 1.5	19.5	25.6	66.1	40.5	0.8	8	21	1	0.8	34	119	33 200	64 500	37 500	
M20 × 1.5	19.5	25.6	66.1	40.5	0.8	8	21	1	0.8	34	119	33 200	64 500	37 500	
M24 × 1.5	25.5	30.6	80.1	49.5	0.8	8	24	1	0.8	40	215	46 600	92 000	52 000	
M24 × 1.5	25.5	30.6	80.1	49.5	0.8	8	24	1	0.8	40	215	46 600	92 000	52 000	
M30 × 1.5	32.5	37	100	63	1	8	30.5	1	1.5	49	438	67 700	144 000	85 900	
M30 × 1.5	32.5	37	100	63	1	8	30.5	1	1.5	49	438	67 700	144 000	85 900	
M30 × 1.5	32.5	37	100	63	1	8	30.5	1	1.5	49	438	67 700	144 000	85 900	

1N=0.102kgf=0.2248lbs.
1mm=0.03937inch

CAM FOLLOWERS

Thrust Disk Type Cam Followers With Cage/With Hexagon Hole

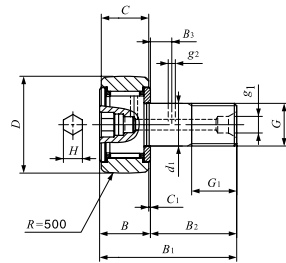

CF...WBR

Stud dia. 3 – 12mm

Stud dia. mm	Identification number		Mass (Ref.) g	Boundary dimensions mm				
	Shield type	Sealed type		D	C	d ₁	G	G ₁
3	CF 3 WBR	CF 3 WBUUR	4.3	10	7	3	M 3 × 0.5	5
4	CF 4 WBR	CF 4 WBUUR	7.4	12	8	4	M 4 × 0.7	6
5	CF 5 WBR	CF 5 WBUUR	10.3	13	9	5	M 5 × 0.8	7.5
6	CF 6 WBR	CF 6 WBUUR	18.5	16	11	6	M 6 × 1	8
8	CF 8 WBR	CF 8 WBUUR	28.5	19	11	8	M 8 × 1.25	10
10	CF 10 WBR	CF 10 WBUUR	45	22	12	10	M10 × 1.25	12
	CF 10-1 WBR	CF 10-1 WBUUR	60	26	12	10	M10 × 1.25	12
12	CF 12 WBR	CF 12 WBUUR	95	30	14	12	M12 × 1.5	13
	CF 12-1 WBR	CF 12-1 WBUUR	105	32	14	12	M12 × 1.5	13

Remarks1. Models with a stud diameter d_1 of 4 mm or less have no oil hole. For Models with a stud dia. 5 to 10 mm, oil hole (re-greasing fitting) is provided at the head. Other models are provided with an oil hole (grease nipple) at the head and an oil hole each on the outside surface and end surface of the stud.

2. Shield type models with a stud diameter d_1 of 10 mm or less and the sealed type models are provided with prepacked grease. Other models are not provided with prepacked grease. Perform proper lubrication for use.

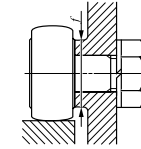
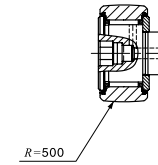

CF...WBUUR

B	B ₁	B ₂	B ₃	C ₁	g ₁	g ₂	H	Mounting dimension f Min. mm	Maximum tightening torque N·m	Basic dynamic load rating C N	Basic static load rating C ₀ N	Maximum allowable static load N
8	17	9	—	0.5	—	—	2	6.8	0.34	1 500	1 020	384
9	20	11	—	0.5	—	—	2.5	8.3	0.78	2 070	1 590	834
10	23	13	—	0.5	—	—	3	9.3	1.6	2 520	2 140	1 260
12.2 max	28.2 max	16	—	0.6	—	—	3	11	2.7	3 660	3 650	1 950
12.2 max	32.2 max	20	—	0.6	—	—	4	13	6.5	4 250	4 740	4 620
13.2 max	36.2 max	23	—	0.6	—	—	4	16	13.8	5 430	6 890	6 890
13.2 max	36.2 max	23	—	0.6	—	—	4	16	13.8	5 430	6 890	6 890
15.2 max	40.2 max	25	6	0.6	6	3	6	21	21.9	7 910	9 790	9 790
15.2 max	40.2 max	25	6	0.6	6	3	6	21	21.9	7 910	9 790	9 790

1N=0.102kgf=0.2248lbs.
1mm=0.03937inch

I
CF
NUCF
CFS
CR

CAM FOLLOWERS

Thrust Disk Type Stainless Steel Made Cam Followers With Cage/With Hexagon Hole

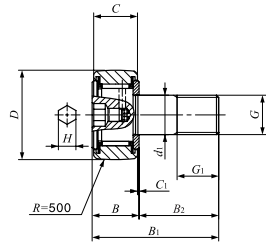

CF...FWBR

Stud dia. 3—5mm

Stud dia. mm	Identification number		Mass (Ref.) g	Boundary dimensions mm				
	Shield type	Sealed type		D	C	d ₁	G	G ₁
3	CF 3 FWBR	CF 3 FWBUUR	4.3	10	7	3	M 3 × 0.5	5
4	CF 4 FWBR	CF 4 FWBUUR	7.4	12	8	4	M 4 × 0.7	6
5	CF 5 FWBR	CF 5 FWBUUR	0.3	3	9		M × 0.8	7.5

Remarks 1. Models with a stud diameter d_1 of 4 mm or less have no oil hole. For models with a stud dia. 5 mm, oil hole (re-greasing fitting) is provided at the head.
2. Provided with prepacked grease.



CF...FWBUUR

B	B ₁	B ₂	C ₁	H	Mounting dimension f Min. mm	Maximu tightening torque N·m	Basic dynamic load rating C N	Basic static load rating C ₀ N	Maximum allowable static load N
8	17	9	0.5	2	6.8	0.34	1 200	813	384
9	20	11	0.5	2.5	8.3	0.78	1 650	1 270	834
0	23	3	0.5	3	9.3	.6	930	730	260

N=0.102kgf=0.2248lbs.
1mm=0.03937inch

CAM FOLLOWERS

Centralized Lubrication Type Cam Followers **With Cage/With Screwdriver Slot**

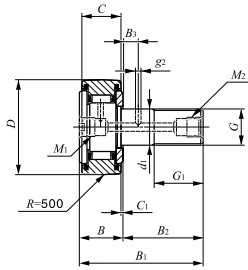

Stud dia. 6 – 30mm

CF...RU1

Stud dia. mm	Identification number		Mass (Ref.) g	Boundary dimensions mm				
	With crowned outer ring	With cylindrical outer ring		D	C	d ₁	G	G ₁
6	CF-RU1- 6	CF-FU1- 6	18.5	16	11	6	M 6 × 1	8
8	CF-RU1- 8	CF-FU1- 8	28.5	19	11	8	M 8 × 1.25	10
10	CF-RU1-10	CF-FU1-10	45	22	12	10	M10 × 1.25	12
	CF-RU1-10-1	CF-FU1-10-1	60	26	12	10	M10 × 1.25	12
12	CF-RU1-12	CF-FU1-12	95	30	14	12	M12 × 1.5	13
	CF-RU1-12-1	CF-FU1-12-1	105	32	14	12	M12 × 1.5	13
16	CF-RU1-16	CF-FU1-16	170	35	18	16	M16 × 1.5	17
18	CF-RU1-18	CF-FU1-18	250	40	20	18	M18 × 1.5	19
20	CF-RU1-20	CF-FU1-20	460	52	24	20	M20 × 1.5	21
	CF-RU1-20-1	CF-FU1-20-1	385	47	24	20	M20 × 1.5	21
24	CF-RU1-24	CF-FU1-24	815	62	29	24	M24 × 1.5	25
	CF-RU1-24-1	CF-FU1-24-1	1 140	72	29	24	M24 × 1.5	25
30	CF-RU1-30	CF-FU1-30	1 870	80	35	30	M30 × 1.5	32
	CF-RU1-30-1	CF-FU1-30-1	2 030	85	35	30	M30 × 1.5	32
	CF-RU1-30-2	CF-FU1-30-2	2 220	90	35	30	M30 × 1.5	32

Note(1) Minimum allowable value of chamfer dimension r

Remarks1. Models with a stud diameter d₁ of 12 mm or less are provided with a lubrication tapped hole on the stud head only. Other models are provided with one lubrication tapped hole each on the head and end surface of the stud.

2. Provided with prepacked grease.



CF...FU1

B _{max}	B _{1 max}	B ₂	B ₃	C ₁	g ₂	M ₁	M ₂	r _{s min} ⁽¹⁾	Mounting dimension f Min. mm	Maximum tightening torque N-m	Basic dynamic load rating C N	Basic static load rating C ₀ N	Maximum allowable static load N
12.2	28.2	16	—	0.6	—	M6× 0.75	—	0.3	11	2.7	3 660	3 650	1 950
12.2	32.2	20	—	0.6	—			0.3	13	6.5	4 250	4 740	4 620
13.2	36.2	23	—	0.6	—			0.3	16	13.8	5 430	6 890	6 890
13.2	36.2	23	—	0.6	—			0.3	16	13.8	5 430	6 890	6 890
15.2	40.2	25	—	0.6	—	PT 1/8	PT 1/8	0.6	21	23.9	7 910	9 790	9 790
15.2	40.2	25	—	0.6	—			0.6	21	23.9	7 910	9 790	9 790
19.6	52.1	32.5	8	0.8	3			0.6	26	58.5	12 000	18 300	18 300
21.6	58.1	36.5	8	0.8	3			1	29	86.2	14 800	25 200	25 200
25.6	66.1	40.5	9	0.8	4	PT 1/8	PT 1/8	1	34	119	20 700	34 600	34 600
25.6	66.1	40.5	9	0.8	4			1	34	119	20 700	34 600	34 600
30.6	80.1	49.5	11	0.8	4			1	40	215	30 500	52 600	52 000
30.6	80.1	49.5	11	0.8	4			1	40	215	30 500	52 600	52 000
37	100	63	15	1	4	PT 1/8	PT 1/8	1	49	438	45 400	85 100	85 100
37	100	63	15	1	4			1	49	438	45 400	85 100	85 100
37	100	63	15	1	4			1	49	438	45 400	85 100	85 100

I
CF
NUCF
CFS
CR

CAM FOLLOWERS

Easy Mounting Type Cam Followers With Cage/With Hexagon Hole

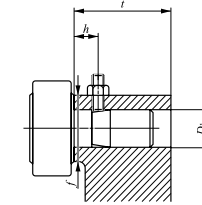
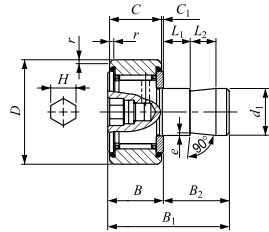

Stud dia. 6–20mm

CF-SFU...B

Stud dia. mm	Identification number	Mass (Ref.) g	Boundary dimensions mm							
			D	C	d ₁	B max	B ₁ max	B ₂	C ₁	L ₁
6	CF-SFU- 6 B	19.5	6	1	6	12.2	32	19.8	0.6	5
8	CF-SFU- 8 B	29	9	1	8	12.2	32	19.8	0.6	5
10	CF-SFU-10 B	44	22	2	0	13.2	33	19.8	0.6	5
	CF-SFU-10-1 B	59	26	2	0	13.2	33	19.8	0.6	5
12	CF-SFU-12 B	94	0	4	2	15.2	35	19.8	0.6	5
	CF-SFU-12-1 B	104	2	4	2	15.2	35	19.8	0.6	5
16	CF-SFU-16 B	164	5	8	6	19.6	44.5	24.9	0.8	10
18	CF-SFU-18 B	235	40	20	8	21.6	46.5	24.9	0.8	10
20	CF-SFU-20 B	435	52	24	20	25.6	50.5	24.9	0.8	10
	CF-SFU-20-1 B	360	47	24	20	25.6	50.5	24.9	0.8	10

Note(1) Minimum allowable value of chamfer dimension r
 Remarks1. Models with a stud diameter d_1 of 10 mm or less have an oil hole (re-greasing fitting) at the head. Other models are provided with an oil hole (grease nipple) at the head.
 2. Provided with prepacked grease.

				Mounting dimensions mm					Basic dynamic load rating C	Basic static load rating C ₀	Maximum allowable static load
L ₂	H	e	r _s min ¹⁾	D ₁	Tolerance	t Min.	f Min.	h (Ref.)	N	N	N
10	3	0.3	0.3	6	+0.012 0	20	11	10	3 660	3 650	1 950
0	4	0.5	0.3	8	+0.0 5 0	20	0	0	4 250	4 740	4 620
10	4	0.5	0.3	10		20	16	10	5 430	6 890	6 890
10	4	0.5	0.3	10	+0.018 0	20	16	10	5 430	6 890	6 890
10	6	1	0.6	12		20	21	10	7 910	9 790	9 790
10	6	1	0.6	12		20	21	10	7 910	9 790	9 790
10	6	1	0.6	16	+0.018 0	25	26	15	12 000	18 300	18 300
10	8	1	1	18		25	29	15	14 800	25 200	25 200
10	8	1	1	20	+0.021 0	25	34	15	20 700	34 600	34 600
10	8	1	1	20		25	34	15	20 700	34 600	34 600

I
CF
NUCF
CFS
CR

CAM FOLLOWERS

Easy Mounting Type Cam Followers **With Cage/With Screwdriver Slot**

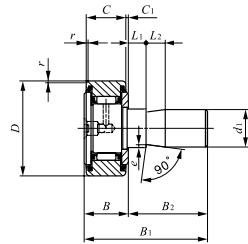

CF...SFU

Stud dia. 6 – 20mm

Stud dia. mm	Identification number	Mass (Ref.) g	Boundary dimensions mm							
			D	C	d ₁	B _{max}	B _{1max}	B ₂	C ₁	L ₁
6	CF-SFU- 6	19.5	16	11	6	12.2	32	19.8	0.6	5
8	CF-SFU- 8	29			8	2.2	32	.8	0.6	5
10	CF-SFU-10	44	22	12	10	13.2	33	19.8	0.6	5
	CF-SFU-10-1	59	26	12	10	13.2	33	19.8	0.6	5
12	CF-SFU-12	94	30	14	12	15.2	35	19.8	0.6	5
	CF-SFU-12-1	104	32	14	12	15.2	35	19.8	0.6	5
16	CF-SFU-16	164	35	18	16	19.6	44.5	24.9	0.8	10
18	CF-SFU-18	235	0	20	18	21.6	46.5	24.9	0.8	10
20	CF-SFU-20	435	52	24	20	25.6	50.5	24.9	0.8	10
	CF-SFU-20-1	360	47	24	20	25.6	50.5	24.9	0.8	10

Note(1) Minimum allowable value of chamfer dimension r
 Remarks1. No oil hole is provided.
 2. Provided with prepacked grease.

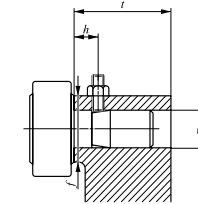

L ₂	e	r _{s min} ⁽¹⁾	Mounting dimensions mm					Basic dynamic load rating C N	Basic static load rating C ₀ N	Maximum allowable static load N
			D ₁	Tolerance	t Min.	f Min.	h (Ref.)			
10	0.3	0.3	6	+0.012 0	20	11	10	3 660	3 650	1 950
0	0.5	0.3	8	+0.05 0	20	3	0	250	0	620
10	0.5	0.3	10		20	16	10	5 430	6 890	6 890
10	0.5	0.3	10	+0.018 0	20	16	10	5 430	6 890	6 890
10	1	0.6	12		20	21	10	7 910	9 790	9 790
10	1	0.6	12	+0.018 0	20	21	10	7 910	9 790	9 790
10	1	0.6	16		25	26	15	2 000	18 300	18 300
10	1	1	18	+0.021 0	25	29	15	4 800	25 200	25 200
10	1	1	20		25	34	15	20 700	34 600	34 600
10	1	1	20	+0.021 0	25	34	15	20 700	34 600	34 600
10	1	1	20		25	34	15	20 700	34 600	34 600

I
 CF
 NUCF
 CFS
 CR

CAM FOLLOWERS

Heavy Duty Type Cam Followers **Full Compliment Type/With Hexagon Hole**

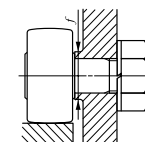
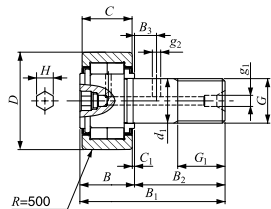
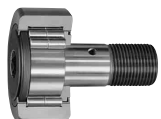

Stud dia. 10 – 30mm

NUCF...BR

Stud dia. mm	Identification number	Mass (Ref.) g	Boundary dimensions mm							
			D	C	d ₁	G	G ₁	B _{max}	B _{1max}	B ₂
10	NUCF 10 BR	44	22	12	10	M10 × 1.25	12	13.2	36.2	23
	NUCF 10-1 BR	58	22	12	10	M10 × 1.25	12	13.2	36.2	23
12	NUCF 12 BR	86	30	14	12	M12 × 1.5	13	14.2	40.2	25
	NUCF 12-1 BR	97	32	14	12	M12 × 1.5	13	14.2	40.2	25
16	NUCF 16 BR	167	33	18	16	M16 × 1.5	17	17.1	52.1	32.5
18	NUCF 18 BR	244	40	20	18	M18 × 1.5	18	21.1	58.1	36.5
20	NUCF 20 BR	457	52	24	20	M20 × 1.5	21	22.1	66.1	40.5
	NUCF 20-1 BR	384	47	24	20	M20 × 1.5	21	22.1	66.1	40.5
24	NUCF 24 BR	789	62	29	24	M24 × 1.5	22	30.1	80.1	49.5
	NUCF 24-1 BR	1 020	72	29	24	M24 × 1.5	22	30.1	80.1	49.5
30	NUCF 30 BR	1 000	80	35	30	M30 × 1.5	32	37.1	100	63
	NUCF 30-2 BR	1 700	90	35	30	M30 × 1.5	32	37.1	100	63

Remarks 1. Models with a stud diameter d_1 of 10 mm or less (marked *) are provided with an oil hole (re-greasing fitting) on the stud head only. Other models are provided with one oil hole each on the head, outside surface and end surface of the stud.
2. Provided with prepacked grease.

B ₃	C ₁	g ₁	g ₂	H	Counting dimension f Min. mm	Maximum tightening torque N-m	Basic dynamic load rating C N	Basic static load rating C ₀ N	Maximum allowable static load N
—	0.6	—	—	4	12	13.8	10 400	11 500	5 300
—	0.6	—	—	4	12	13.8	10 400	11 500	9 210
	0.6	4	3		17	21.9	14 000	13 400	0
	0.6	4	3		17	21.9	14 000	13 400	040
8	0.8	4	3	6	20	58.5	23 400	27 300	11 800
8	0.8	6	3	8	22	86.2	25 200	30 900	20 300
9	0.8	6	4	8	31	119	43 100	58 100	30 000
9	0.8	6	4	8	27	119	38 900	49 000	27 200
11	0.8	6	4	12	38	215	58 200	75 300	35 200
11	0.8	6	4	12	44	215	63 900	88 800	57 000
15	1	6	4	17	45	438	90 300	121 000	98 300
15	1	6	4	17	45	438	90 300	121 000	98 300

I
CF
NUCF
CFS
CR

CAM FOLLOWERS

Heavy Duty Type Cam Followers Full Compliment Type/With Screwdriver Slot

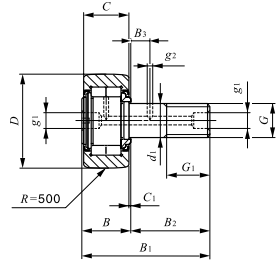

NUCF...R

Stud dia. 10 – 30mm

Stud dia. mm	Identification number	Mass (Ref.) g	Boundary dimensions mm							
			D	C	d ₁	G	G ₁	B _{max}	B _{1max}	B ₂
10	NUCF 10 R	44	22	12	10	M10 × 1.25	12	13.2	36.2	23
	NUCF 10-1 R	58	26	12	10	M10 × 1.25	12	13.2	36.2	23
12	NUCF 12 R	6	14	12	12	12 × 1.5	13	15.2	40.2	25
	NUCF 12-1 R	97	2	14	12	M12 × 1.5	13	15.2	40.2	25
16	NUCF 16 R	167	35	18	16	M16 × 1.5	17	19.6	52.1	32.
18	NUCF 18 R	244	40	20	18	M18 × 1.5	19	21.6	58.1	36.
	NUCF 20 R	457	52	24	20	M20 × 1.5	21	25.6	66.1	40.
20	NUCF 20-1 R	384	47	24	20	M20 × 1.5	21	25.6	66.1	40.
	NUCF 24 R	789	62	29	24	M24 × 1.5	25	30.6	80.1	49.
24	NUCF 24-1 R	1 020	72	29	24	M24 × 1.5	25	30.6	80.1	49.
	NUCF 30 R	1 600	80	35	30	M30 × 1.5	32	37	100	63
30	NUCF 30-2 R	1 970	90	35	30	M30 × 1.5	32	37	100	63

Remarks1. Models with a stud diameter d_1 of 10 mm or less (marked *) are provided with an oil hole on the stud head only. Other models are provided with one oil hole each on the head, outside surface and end surface of the stud.
2. Provided with prepacked grease.

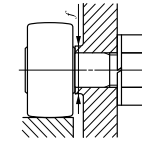

B ₃	C ₁	g ₁	g ₂	Counting dimension f Min. mm	Maximum tightening torque N-m	Basic dynamic load rating	Basic static load rating	Maximum allowable static load
						C	C ₀	N
—	0.6	*4	—	12	13.8	10 40	11 50	5 30
—	0.6	*4	—	12	13.8	10 40	11 50	9 21
6	6	6	—	17	21.9	14 00	13 40	65
6	0.6	6	—	17	21.9	14 00	13 40	9 04
8	0.8	6	3	20	58.5	23 40	27 30	11 80
8	0.8	6	—	22	86.2	25 20	30 90	20 30
9	0.8	8	4	31	119	43 10	58 10	30 00
9	0.8	8	4	27	119	38 90	49 00	27 20
11	0.8	8	4	38	215	58 20	75 30	35 20
11	0.8	8	4	44	215	63 90	88 80	57 00
15	1	8	4	45	438	90 30	121 00	98 30
15	1	8	4	45	438	90 30	121 00	98 30

1N=0.102kgf=0.2248lbs.
1mm=0.03937inch

I
CF
NUCF
CFS
CR

CAM FOLLOWERS

Miniature Type Cam Followers **With Cage/With Hexagon Hole**
Full Complement Type/With Hexagon Hole

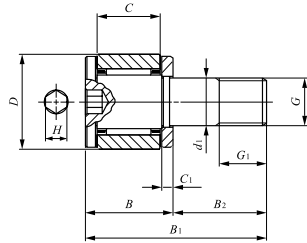

CFS

Stud dia. 2 – 6mm

Stud dia. mm	Identification number		Mass (Ref.) g	Boundary dimensions mm					
	With cage	Full complement		D	C	d ₁	G	G ₁	B
2	CFS 2	—	0.6	4.5	2.5	2	M2 × 0.4	2	4
	—	CFS 2 V	0.6	4.5	2.5	2	M2 × 0.4	2	4
2.5	CFS 2.5	—	1	5	3	2.5	M2.5 × 0.45	2.5	4.5
	—	CFS 2.5 V	1	5	3	2.5	M2.5 × 0.45	2.5	4.5
3	CFS 3	—		6	4	3	M3 × 0.5	3	5.5
	—	CFS 3 V		6	4	3	M3 × 0.5	3	5.5
4	CFS 4	—		8	5		M4 × 0.7		7
	—	CFS 4 V		8	5		M4 × 0.7		7
5	CFS 5	—	7	10	6	5	M5 × 0.8	5	8
	—	CFS 5 V	7	10	6	5	M5 × 0.8	5	8
6	CFS 6	—	13	12	7	6	M6 × 1	6	9.5
	—	CFS 6 V	13	12	7	6	M6 × 1	6	9.5

Remarks 1. No oil hole is provided.
 2. Provided with prepacked grease.

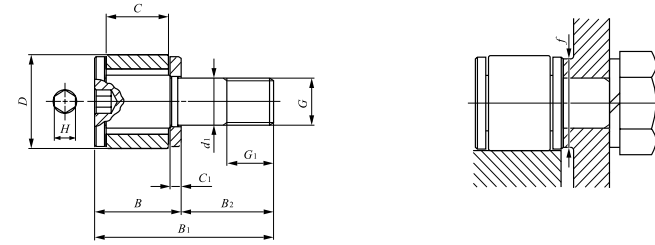

CFS...V

B ₁	B ₂	C ₁	H	Mounting dimension f Min. mm	Maximum tightening torque N·m	sic dynamic load rating C N	Basic static load rating C ₀ N	Maximum allowable static load N
8	4	0.7	0.9	4.3	9.1	768	734	229
9.5	5	0.7	0.9	4.8	18.7	342	281	351
9.5	5	0.7	0.9	4.8	18.7	800	862	360
.5	6	0.7	.3	5.8	33.5	504	88	84
11.5	6	0.7	1.3	5.8	33.5	1 140	430	484
15	8	1.0	1.5	7.7	77.7	897	894	919
15	8	1.0	1.5	7.7	77.7	1 900	2 400	919
18	10	1.0	2	9.6	158	1 250	480	570
18	10	1.0	2	9.6	158	2 540	3 760	570
21.5	12	1.2	2.5	11.6	268	1 670	1 760	2 150
21.5	12	1.2	2.5	11.6	268	3 690	5 000	2 150

1N=0.102kgf=0.2248lbs.
 1mm=0.03937inch

CAM FOLLOWERS

Miniature Type Cam Followers Stainless Steel Made **With Cage/With Hexagon Hole**
Full Complement Type/With Hexagon Hole

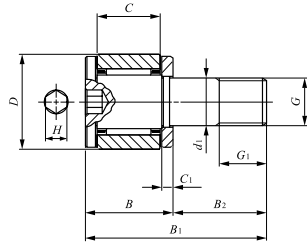

C S...F

Stud dia. 2—6mm

Stud dia. mm	Identification number		Mass (Ref.) g	Boundary dimensions mm					
	With cage	Full complement		D	C	d ₁	G	G ₁	B
2	CFS 2 F	—	0.6	4.5	2.5	2	M2 × 0.4	2	4
	—	CFS 2 FV	0.6	4.5	2.5	2	M2 × 0.4	2	4
2.5	CFS 2.5 F	—	1	5	3	2.5	M2.5 × 0.45	2.5	4.5
	—	CFS 2.5 FV	1	5	3	2.5	M2.5 × 0.45	2.5	4.5
3	CFS 3 F	—		6		3	M3 × 0.5	3	5.5
	—	CFS 3 FV		6		3	M3 × 0.5	3	5.5
4	CFS 4 F	—	4	8	5	4	M4 × 0.7	4	7
	—	CFS 4 FV	4	8	5	4	M4 × 0.7	4	7
5	CFS 5 F	—	7	10	6	5	M5 × 0.8	5	8
	—	CFS 5 FV	7	10	6	5	M5 × 0.8	5	8
6	CFS 6 F	—	13	12	7	6	M6 × 1	6	9.5
	—	CFS 6 FV	13	12	7	6	M6 × 1	6	9.5

Remarks 1. No oil hole is provided.
 2. Provided with prepacked grease.

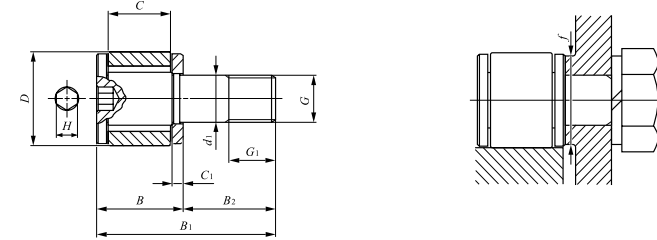

S...FV

B ₁	B ₂	C ₁	H	Mounting dimension f Min. mm	Maximum tightening torque N-cm	Basic dynamic load rating	Basic static load rating	Maximum allowable static load
						C	C ₀	N
8	4	0.7	0.9	4.3	9.1	230	161	202
8	4	0.7	0.9	4.3	9.1	768	734	229
9.5	5	0.7	0.9	4.8	18.7	342	281	281
9.5	5	0.7	0.9	4.8	18.7	800	862	360
.5	6	0.7	.3	5.8	33.5	504	88	84
11.5	6	0.7	1.3	5.8	33.5	1 140	430	484
15	8	1.0	1.5	7.7	77.7	897	894	894
15	8	1.0	1.5	7.7	77.7	1 900	2 400	919
18	10	1.0	2	9.6	158	1 250	480	480
18	10	1.0	2	9.6	158	2 540	3 760	570
21.5	12	1.2	2.5	11.6	268	1 670	1 760	760
21.5	12	1.2	2.5	11.6	268	3 690	5 000	150

1N=0.102kgf=0.2248lbs.
 1mm=0.03937inch

CAM FOLLOWERS

Thrust Disk Type Miniature Cam Followers **With Cage/With Hexagon Hole**

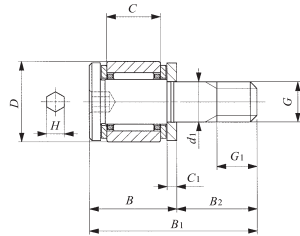

CFS... W

Stud dia. 2 – 6 mm

Stud dia. mm	Identification number	Mass (Ref.) g	Boundary dimensions mm					
			D	C	d ₁	G	G ₁	B
2	CFS 2 W	0.6	4.5	2.5	2	M2 × 0.4	2	4.5
2.5	CFS 2.5 W	1	5	3	2.5	M2.5 × 0.45	2.5	5
3	CFS 3 W	2	6	4	3	M3 × 0.5	3	6.5
4	CFS 4 W	4	8	5	4	M4 × 0.7	4	8
5	CFS 5 W	7	10	6	5	M5 × 0.8	5	9
6	CFS 6 W	13	12	7	6	M6 × 1	6	10.5

Remarks 1. No oil hole is provided.
2. Provided with prepacked grease.

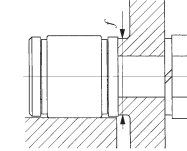

B ₁	B ₂	C ₁	H	Mounting dimension f Min. mm	Maximum tightening torque N-cm	Basic dynamic load rating C N	Basic static load rating C ₀ N	Maximum allowable static load N
8.5	4	0.7	0.9	4.3	9.1	288	202	194
10	5	0.7	0.9	4.8	18.7	428	351	313
12.5	6	0.7	1.3	5.8	33.5	629	611	399
16	8	1.0	1.5	7.7	77.7	1 120	1 120	785
19	10	1.0	2	9.6	158	1 570	1 850	1 370
22.5	12	1.2	2.5	11.6	268	2 090	2 200	1 920

I
CF
NUCF
CFS
CR

CAM FOLLOWERS

Thrust Disk Type Miniature Cam Followers · Stainless Steel Made **With Cage/With Hexagon Hole**

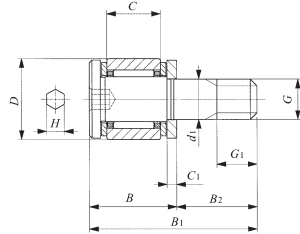

S... W

Stud dia. 2 – 6 mm

Stud dia. mm	Identification number	Mass (Ref.) g	Boundary dimensions mm					
			D	C	d ₁	G	G ₁	B
2	CFS 2 FW	0.6	.5	2.5	2	M2 × 0.4	2	.5
2.5	CFS 2.5 FW	1	5	3	2.5	M2.5 × 0.45	2.5	5
3	CFS 3 FW	2	6	4	3	M3 × 0.5	3	6.5
4	CFS 4 FW	4	8	5	4	M4 × 0.7	4	8
5	CFS 5 FW	7	10	6	5	M5 × 0.8	5	9
6	CFS 6 FW	13	12	7	6	M6 × 1	6	10.5

Remarks 1. No oil hole is provided.
2. Provided with prepacked grease.

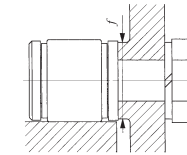

B ₁	B ₂	C ₁	H	Mountin dimension f Min. mm	Maximum tightening torque N-cm	Basic dynamic load rating C N	Basic static load rating C ₀ N	Maximum allowable static load N
.5		0.7	0.9	.3	9.1	230	161	161
10	5	0.7	0.9	4.8	18.7	342	281	281
12.5	6	0.7	1.3	5.8	33.5	504	488	399
16	8	1.0	1.5	7.7	77.7	897	894	785
19	10	1.0	2	9.6	158	1 250	1 480	1 370
22.5	12	1.2	2.5	11.6	268	1 670	1 760	1 760

1N=0.102kgf=0.2248lbs.
1mm=0.03937inch

CAM FOLLOWERS

Inch Series Cam Followers **With** age/With Hexagon Hole

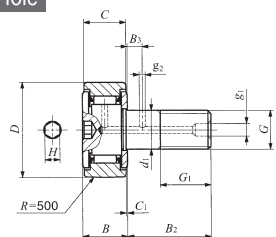

R...BR

Stud dia. 4.826 – 22.225 mm

Stud dia. mm (inch)	Identification number				Mass (Ref.) g	Boundary dimensions mm (inch)				
	Shield type		Sealed type			D	C	d ₁	G UNF	G ₁
	With crowned outer ring	With cylindrical outer ring	With crowned outer ring	With cylindrical outer ring						
4.826	CR 8 BR	CR 8 B	CR 8 BUUR	CR 8 BUU	9	12.700 (1/2)	8.731 (1/2)	4.82	No.1 -32	.3 0 (1/4)
	CR 8-1 BR	CR 8-1 B	CR 8-1 BUUR	CR 8-1 BUU	10	12.700 (1/2)	9.525 (1/2)	4.82	No.1 -32	.3 0 (1/4)
6.350 (1/4)	CR 10 BR	CR 10 B	CR 10 BUUR	CR 10 BUU	19	15.75 (1/2)	10.319 (1/2)	.3 (1/4)	1/4 - 28	7.9 8 (3/8)
	CR 10-1 BR	CR 10-1 B	CR 10-1 BUUR	CR 10-1 BUU	21	15.75 (1/2)	11.112 (1/2)	.3 (1/4)	1/4 - 28	7.9 8 (3/8)
9.525 (3/8)	CR 12 BR	CR 12 B	CR 12 BUUR	CR 12 BUU	35	19.50 (1/2)	12.700 (1/2)	9.52 (3/8)	3/8 - 24	9.525 (3/8)
	CR 14 BR	CR 14 B	CR 14 BUUR	CR 14 BUU	46	22.225 (1/2)	12.700 (1/2)	9.52 (3/8)	3/8 - 24	9.525 (3/8)
11.112 (7/16)	CR 16 BR	CR 16 B	CR 16 BUUR	CR 16 BUU	73	25.400 (1)	15.875 (1/2)	11.112 (3/8)	1/2 - 20	12.7 0 (1/2)
	CR 18 BR	CR 18 B	CR 18 BUUR	CR 18 BUU	88	28.75 (1 1/8)	15.875 (1/2)	11.112 (3/8)	1/2 - 20	12.7 0 (1/2)
12.700 (1/2)	CR 20 BR	CR 20 B	CR 20 BUUR	CR 20 BUU	132	31.750 (1 1/8)	19.050 (1/2)	12.7 (1/2)	1/2 - 20	1.875 (3/8)
	CR 22 BR	CR 22 B	CR 22 BUUR	CR 22 BUU	157	34.925 (1 3/8)	19.050 (1/2)	12.7 (1/2)	1/2 - 20	1.875 (3/8)
15.875 (5/8)	CR 24 BR	CR 24 B	CR 24 BUUR	CR 24 BUU	225	38.100 (1 1/2)	22.225 (1/2)	1.87 (3/8)	3/8 - 18	19.0 0 (3/4)
	CR 26 BR	CR 26 B	CR 26 BUUR	CR 26 BUU	260	41.275 (1 5/8)	22.225 (1/2)	1.87 (3/8)	3/8 - 18	19.0 0 (3/4)
19.050 (3/4)	CR 28 BR	CR 28 B	CR 28 BUUR	CR 28 BUU	365	44.450 (1 3/4)	25.400 (1)	19.0 (3/4)	1/4 - 16	22.225 (3/8)
	CR 30 BR	CR 30 B	CR 30 BUUR	CR 30 BUU	410	47.25 (1 7/8)	25.400 (1)	19.0 (3/4)	1/4 - 16	22.225 (3/8)
22.225 (7/8)	CR 32 BR	CR 32 B	CR 32 BUUR	CR 32 BUU	615	50.00 (2)	31.750 (1 1/8)	22.22 (3/8)	3/8 - 14	2.4 0 (1)
	CR 36 BR	CR 36 B	CR 36 BUUR	CR 36 BUU	750	57.150 (2 1/8)	31.750 (1 1/8)	22.22 (3/8)	3/8 - 14	2.4 0 (1)

Remarks 1. Models with a stud diameter d_1 of 6.35 mm or less have no oil hole. Other models are provided with one oil hole each on the outside surface and end surface of the stud.
2. Provided with prepacked grease.

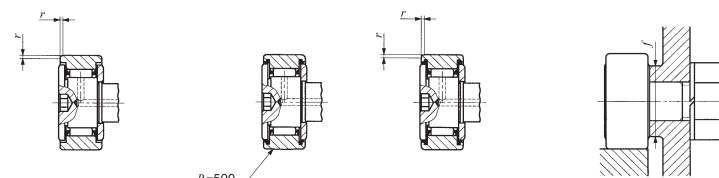

R...B

CR...BUUR

CR...BUU

Boundary dimensions mm (inch)								Mounting dimension f Min. mm (inch)	Maximum tightening torque N-m	Basic dynamic load rating C N	Basic static load rating C ₀ N
B max	B ₂	B ₃	C ₁	g ₁	g ₂	H	r				
10.2 (0.40)	12.700 (1/2)	— (—)	0.794 (1/32)	— (—)	— (—)	3.175 (1/8)	.397 (1/64)	3.34 (1/16)	1.4	2 520	2 140
10.9 (0.43)	15.875 (3/8)	— (—)	0.794 (1/32)	— (—)	— (—)	3.175 (1/8)	0.397 (1/64)	8.334 (1/32)	1.4	2 520	2 140
11.8 (0.46)	15.875 (3/8)	— (—)	0.794 (1/32)	— (—)	— (—)	3.175 (1/8)	0.397 (1/64)	11.509 (3/8)	3.4	3 650	3 670
12.5 (0.49)	19.050 (3/4)	— (—)	0.794 (1/32)	— (—)	— (—)	3.175 (1/8)	0.397 (1/64)	11.509 (3/8)	3.4	3 650	3 670
14.2 (0.56)	22.225 (1/2)	6.350 (1/4)	0.794 (1/32)	4.762 (1/8)	2.381 (1/32)	4.762 (1/8)	0.794 (1/32)	13.494 (1/2)	10.8	4 420	5 110
14.2 (0.56)	22.225 (1/2)	6.350 (1/4)	0.794 (1/32)	4.762 (1/8)	2.381 (1/32)	4.762 (1/8)	0.794 (1/32)	15.081 (1/2)	10.8	4 790	5 810
17.3 (0.68)	25.400 (1)	6.350 (1/4)	0.794 (1/32)	4.762 (1/8)	3.175 (1/8)	6.350 (1/4)	1.191 (1/32)	17.859 (1/2)	17.4	8 810	10 800
17.3 (0.68)	25.400 (1)	6.350 (1/4)	0.794 (1/32)	4.762 (1/8)	3.175 (1/8)	6.350 (1/4)	1.588 (1/32)	19.050 (1/2)	17.4	9 180	11 600
20.4 (0.80)	31.750 (1 1/8)	7.938 (3/16)	0.794 (1/32)	4.762 (1/8)	3.175 (1/8)	6.350 (1/4)	1.588 (1/32)	21.828 (1 1/8)	27.7	14 200	16 000
20.4 (0.80)	31.750 (1 1/8)	7.938 (3/16)	0.794 (1/32)	4.762 (1/8)	3.175 (1/8)	6.350 (1/4)	1.588 (1/32)	21.828 (1 1/8)	27.7	14 200	16 000
23.6 (0.93)	38.100 (1 1/2)	9.525 (3/8)	0.794 (1/32)	4.762 (1/8)	3.969 (1/32)	7.938 (3/16)	1.588 (1/32)	26.196 (1 1/8)	55.7	18 600	24 300
23.6 (0.93)	38.100 (1 1/2)	9.525 (3/8)	0.794 (1/32)	4.762 (1/8)	3.969 (1/32)	7.938 (3/16)	1.588 (1/32)	26.196 (1 1/8)	55.7	18 600	24 300
26.8 (1.06)	44.450 (1 3/4)	11.112 (3/8)	0.794 (1/32)	4.762 (1/8)	3.969 (1/32)	7.938 (3/16)	1.588 (1/32)	32.543 (1 1/8)	100	25 100	38 200
26.8 (1.06)	44.450 (1 3/4)	11.112 (3/8)	0.794 (1/32)	4.762 (1/8)	3.969 (1/32)	7.938 (3/16)	1.588 (1/32)	32.543 (1 1/8)	100	25 100	38 200
33.5 (1.32)	50.800 (2)	12.700 (1/2)	0.794 (1/32)	4.762 (1/8)	4.762 (1/8)	11.112 (3/8)	1.588 (1/32)	37.306 (1 1/2)	162	32 500	63 900
33.5 (1.32)	50.800 (2)	12.700 (1/2)	0.794 (1/32)	4.762 (1/8)	4.762 (1/8)	11.112 (3/8)	1.588 (1/32)	37.306 (1 1/2)	162	32 500	63 900

1N=0.102kgf=0.2248lbs.
1mm=0.03937i ch

I
CF
NUCF
CFS
CR

CAM FOLLOWERS

Inch Series Cam Followers With Cage/With Screwdriver Slot

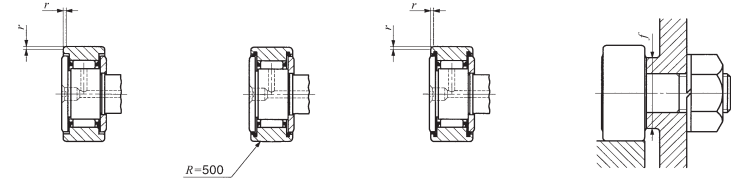
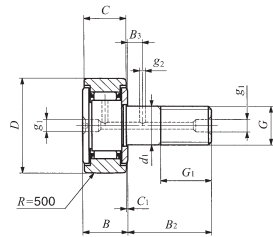

Stud dia. 4.826 – 22.225 mm

CR...R

Stud dia. mm (inch)	Identification number				Mass (Ref.) g	Boundary dimensions mm(inch)				
	Shield type With crowned outer ring		Sealed type With crowned outer ring			D	C	d ₁	G UNF	G ₁
4.826 (1/4)	CR 8 R	CR 8	CR 8 UUR	CR 8 UU	9	12.700 (1/2)	8.731 (1/2)	4.826	No.10-32	6.350 (1/4)
	CR 8-1 R	CR 8-1	CR 8-1 UUR	CR 8-1 UU	10	12.700 (1/2)	9.525 (3/8)	4.826	No.10-32	6.350 (1/4)
6.350 (1/4)	CR 10 R	CR 10	CR 10 UUR	CR 10 UU	19	15.875 (5/8)	10.319 (13/16)	6.350 (1/4)	1/4 - 28	7.938 (5/16)
	CR 10-1 R	CR 10-1	CR 10-1 UUR	CR 10-1 UU	21	15.875 (5/8)	11.112 (7/16)	6.350 (1/4)	1/4 - 28	7.938 (5/16)
9.525 (3/8)	CR 12 R	CR 12	CR 12 UUR	CR 12 UU	35	19.050 (3/4)	12.700 (1/2)	9.525 (3/8)	3/8 - 24	9.525 (3/8)
	CR 14 R	CR 14	CR 14 UUR	CR 14 UU	46	22.225 (7/8)	12.700 (1/2)	9.525 (3/8)	3/8 - 24	9.525 (3/8)
11.112 (7/16)	CR 16 R	CR 16	CR 16 UUR	CR 16 UU	73	25.400 (1)	15.875 (5/8)	11.112 (7/16)	7/16 - 20	12.700 (1/2)
	CR 18 R	CR 18	CR 18 UUR	CR 18 UU	88	28.575 (1 1/8)	15.875 (5/8)	11.112 (7/16)	7/16 - 20	12.700 (1/2)
12.700 (1/2)	CR 20 R	CR 20	CR 20 UUR	CR 20 UU	132	31.750 (1 1/4)	19.050 (3/4)	12.700 (1/2)	1/2 - 20	15.875 (5/8)
	CR 22 R	CR 22	CR 22 UUR	CR 22 UU	157	34.925 (1 3/8)	19.050 (3/4)	12.700 (1/2)	1/2 - 20	15.875 (5/8)
15.875 (5/8)	CR 24 R	CR 24	CR 24 UUR	CR 24 UU	225	38.100 (1 1/2)	22.225 (7/8)	15.875 (5/8)	5/8 - 18	19.050 (3/4)
	CR 26 R	CR 26	CR 26 UUR	CR 26 UU	260	41.275 (1 5/8)	22.225 (7/8)	15.875 (5/8)	5/8 - 18	19.050 (3/4)
19.050 (3/4)	CR 28 R	CR 28	CR 28 UUR	CR 28 UU	365	44.450 (1 3/4)	25.400 (1)	19.050 (3/4)	3/4 - 16	22.225 (7/8)
	CR 30 R	CR 30	CR 30 UUR	CR 30 UU	410	47.625 (1 7/8)	25.400 (1)	19.050 (3/4)	3/4 - 16	22.225 (7/8)
22.225 (7/8)	CR 32 R	CR 32	CR 32 UUR	CR 32 UU	615	50.800 (2)	31.750 (1 1/4)	22.225 (7/8)	7/8 - 14	25.400 (1)
	CR 36 R	CR 36	CR 36 UUR	CR 36 UU	750	57.150 (2 1/4)	31.750 (1 1/4)	22.225 (7/8)	7/8 - 14	25.400 (1)

Remarks 1. Models with a stud diameter d_1 of 6.35 mm or less (marked *) are provided with an oil hole on the stud head only. Other models are provided with one oil hole each on the head, outside surface and end surface of the stud.
2. Provided with prepacked grease.

CR

CR...UUR

CR...UU

Boundary dimensions mm(inch)							Mounting dimension f mm(inch)	Maximum tightening torque N-m	Basic dynamic load rating N	Basic static load rating N
B max	B ₂	B ₃	C ₁	g ₁	g ₂	r				
10.2(0.40)	12.700(1/2)	— (-)	0.794(1/32)	*3.175(1/8)	— (-)	0.397(1/16)	8.334(1/32)	1.4	2 520	2 140
10.9(0.43)	15.875(5/8)	— (-)	0.794(1/32)	*3.175(1/8)	— (-)	0.397(1/16)	8.334(1/32)	1.4	2 520	2 140
11.8(0.46)	15.875(5/8)	— (-)	0.794(1/32)	*3.175(1/8)	— (-)	0.397(1/16)	11.509(9/16)	3.4	3 650	3 670
12.5(0.49)	19.050(3/4)	— (-)	0.794(1/32)	*3.175(1/8)	— (-)	0.397(1/16)	11.509(9/16)	3.4	3 650	3 670
14.2(0.56)	22.225(7/8)	6.350(1/4)	0.794(1/32)	4.762(3/16)	2.381(3/32)	0.794(1/16)	13.494(11/16)	10.8	4 420	5 110
14.2(0.56)	22.225(7/8)	6.350(1/4)	0.794(1/32)	4.762(3/16)	2.381(3/32)	0.794(1/16)	15.081(15/16)	10.8	4 790	5 810
17.3(0.68)	25.400(1)	6.350(1/4)	0.794(1/32)	4.762(3/16)	3.175(1/8)	1.191(1/16)	17.859(11/16)	17.4	8 810	10 800
17.3(0.68)	25.400(1)	6.350(1/4)	0.794(1/32)	4.762(3/16)	3.175(1/8)	1.588(1/16)	19.050(3/4)	17.4	9 180	11 600
20.4(0.80)	31.750(1 1/4)	7.938(5/16)	0.794(1/32)	4.762(3/16)	3.175(1/8)	1.588(1/16)	21.828(11/16)	27.7	14 200	16 000
20.4(0.80)	31.750(1 1/4)	7.938(5/16)	0.794(1/32)	4.762(3/16)	3.175(1/8)	1.588(1/16)	21.828(11/16)	27.7	14 200	16 000
23.6(0.93)	38.100(1 1/2)	9.525(3/8)	0.794(1/32)	4.762(3/16)	3.969(3/16)	1.588(1/16)	26.196(1 1/16)	55.7	18 600	24 300
23.6(0.93)	38.100(1 1/2)	9.525(3/8)	0.794(1/32)	4.762(3/16)	3.969(3/16)	1.588(1/16)	26.196(1 1/16)	55.7	18 600	24 300
26.8(1.06)	44.450(1 3/4)	11.112(7/16)	0.794(1/32)	4.762(3/16)	3.969(3/16)	1.588(1/16)	32.543(1 1/16)	100	25 100	38 200
26.8(1.06)	44.450(1 3/4)	11.112(7/16)	0.794(1/32)	4.762(3/16)	3.969(3/16)	1.588(1/16)	32.543(1 1/16)	100	25 100	38 200
33.5(1.32)	50.800(2)	12.700(1/2)	0.794(1/32)	4.762(3/16)	4.762(3/16)	1.588(1/16)	37.306(1 1/16)	162	32 500	63 900
33.5(1.32)	50.800(2)	12.700(1/2)	0.794(1/32)	4.762(3/16)	4.762(3/16)	1.588(1/16)	37.306(1 1/16)	162	32 500	63 900

1N=0.102kgf=0.2248lbs.
1mm=0.03937inch

CAM FOLLOWERS

Inch Series Cam Followers Full Complement Type/With Hexagon Hole

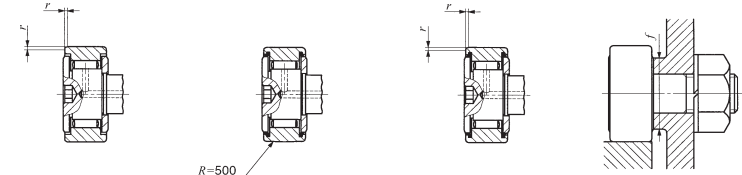
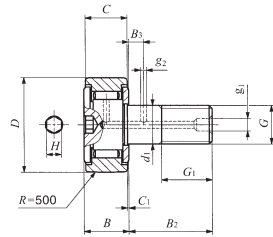

Stud dia. 4.826 – 22.225 mm

CR...VBR

CR...VBR

CR...VBUUR

CR...VBUU

Stud dia. mm (inch)	Identification number				Mass (Ref.) g	Dimensions mm (inch)				
	Shield type		Sealed type			D	C	d ₁	G UNF	G ₁
	With crowned outer ring	With cylindrical outer ring	With crowned outer ring	With cylindrical outer ring						
4.826	CR 8 VBR	CR 8 VB	CR 8 VBUUR	CR 8 VBUU	9	12.700 (1/2)	8.731 (3/8)	.826	No.10-32	6.350 (1/4)
	CR 8-1 VBR	CR 8-1VB	CR 8-1 VBUUR	CR 8-1 VBUU	10	12.700 (1/2)	9.525 (3/8)	4.826	No.10-32	6.350 (1/4)
6.350 (1/4)	CR 10 VBR	CR 10 VB	CR 10 VBUUR	CR 10 VBUU	19	15.875 (5/8)	10.319 (3/8)	6.350 (1/4)	1/4 - 28	7.938 (5/16)
	CR 10-1 VBR	CR 10-1VB	CR 10-1 VBUUR	CR 10-1 VBUU	21	15.875 (5/8)	11.112 (7/16)	6.350 (1/4)	1/4 - 28	7.938 (5/16)
9.525 (3/8)	CR 12 VBR	CR 12 VB	CR 12 VBUUR	CR 12 VBUU	36	19.050 (3/4)	12.700 (1/2)	9.525 (3/8)	3/8 - 24	9.525 (3/8)
	CR 14 VBR	CR 14 VB	CR 14 VBUUR	CR 14 VBUU	47	22.225 (7/8)	12.700 (1/2)	9.525 (3/8)	3/8 - 24	9.525 (3/8)
11.112 (7/16)	CR 16 VBR	CR 16 VB	CR 16 VBUUR	CR 16 VBUU	74	25.400 (1)	15.875 (5/8)	11.112 (7/16)	7/16 - 20	12.700 (1/2)
	CR 18 VBR	CR 18 VB	CR 18 VBUUR	CR 18 VBUU	85	28.575 (1 1/8)	15.875 (5/8)	11.112 (7/16)	7/16 - 20	12.700 (1/2)
12.700 (1/2)	CR 20 VBR	CR 20 VB	CR 20 VBUUR	CR 20 VBUU	137	31.750 (1 1/4)	19.050 (3/4)	12.700 (1/2)	1/2 - 20	15.875 (5/8)
	CR 22 VBR	CR 22 VB	CR 22 VBUUR	CR 22 VBUU	160	34.925 (1 3/8)	19.050 (3/4)	12.700 (1/2)	1/2 - 20	15.875 (5/8)
15.875 (5/8)	CR 24 VBR	CR 24 VB	CR 24 VBUUR	CR 24 VBUU	230	38.100 (1 1/2)	22.225 (7/8)	15.875 (5/8)	5/8 - 18	19.050 (3/4)
	CR 26 VBR	CR 26 VB	CR 26 VBUUR	CR 26 VBUU	265	41.275 (1 5/8)	22.225 (7/8)	15.875 (5/8)	5/8 - 18	19.050 (3/4)
19.050 (3/4)	CR 28 VBR	CR 28 VB	CR 28 VBUUR	CR 28 VBUU	372	44.450 (1 3/4)	25.400 (1)	19.050 (3/4)	3/4 - 16	22.225 (7/8)
	CR 30 VBR	CR 30 VB	CR 30 VBUUR	CR 30 VBUU	418	47.625 (1 7/8)	25.400 (1)	19.050 (3/4)	3/4 - 16	22.225 (7/8)
22.225 (7/8)	CR 32 VBR	CR 32 VB	CR 32 VBUUR	CR 32 VBUU	627	50.800 (2)	31.750 (1 1/4)	22.225 (7/8)	7/8 - 14	25.400 (1)
	CR 36 VBR	CR 36 VB	CR 36 VBUUR	CR 36 VBUU	759	57.150 (2 1/4)	31.750 (1 1/4)	22.225 (7/8)	7/8 - 14	25.400 (1)

Remarks 1. Models with a stud diameter d₁ of 6.35 mm or less have no oil hole. Other models are provided with one oil hole each on the outside surface and end surface of the stud.
2. Provided with prepacked grease.

Boundary dimensions mm (inch)								Mounting dimension f Min. mm (inch)	Maximum tightening torque N-m	Basic dynamic load rating N	Basic static load rating N
B max	B ₂	B ₃	C ₁	g ₁	g ₂	H	r				
10.2(0.40)	12.700 (1/2)	— (-)	0.794 (1/32)	— (-)	— (-)	.175 (1/8)	0.397 (1/8)	8.33 (3/8)	1.4	260	750
10.9(0.43)	15.875 (5/8)	— (-)	0.794 (1/32)	— (-)	— (-)	3.175 (1/8)	0.397 (1/8)	8.334 (3/8)	1.4	4 710	5 410
11.8(0.46)	15.875 (5/8)	— (-)	0.794 (1/32)	— (-)	— (-)	3.175 (1/8)	0.397 (1/8)	11.509 (3/4)	3.4	5 830	7 660
12.5(0.49)	19.050 (3/4)	— (-)	0.794 (1/32)	— (-)	— (-)	3.175 (1/8)	0.397 (1/8)	11.509 (3/4)	3.4	6 340	8 530
14.2(0.56)	22.225 (7/8)	6.350 (1/4)	0.794 (1/32)	4.762 (3/16)	2.381 (3/32)	4.762 (3/16)	0.794 (1/32)	13.494 (1/2)	10.8	8 710	12 300
14.2(0.56)	22.225 (7/8)	6.350 (1/4)	0.794 (1/32)	4.762 (3/16)	2.381 (3/32)	4.762 (3/16)	0.794 (1/32)	15.081 (11/16)	10.8	8 710	12 300
17.3(0.68)	25.400 (1)	6.350 (1/4)	0.794 (1/32)	4.762 (3/16)	3.175 (1/8)	6.350 (1/4)	1.191 (3/16)	17.859 (5/8)	17.4	13 100	22 700
17.3(0.68)	25.400 (1)	6.350 (1/4)	0.794 (1/32)	4.762 (3/16)	3.175 (1/8)	6.350 (1/4)	1.588 (1/8)	19.050 (3/4)	17.4	13 100	22 700
20.4(0.80)	31.750 (1 1/4)	7.938 (5/16)	0.794 (1/32)	4.762 (3/16)	3.175 (1/8)	6.350 (1/4)	1.588 (1/8)	21.828 (7/8)	27.7	23 600	31 700
20.4(0.80)	31.750 (1 1/4)	7.938 (5/16)	0.794 (1/32)	4.762 (3/16)	3.175 (1/8)	6.350 (1/4)	1.588 (1/8)	21.828 (7/8)	27.7	23 600	31 700
23.6(0.93)	38.100 (1 1/2)	9.525 (3/8)	0.794 (1/32)	4.762 (3/16)	3.969 (3/16)	7.938 (5/16)	1.588 (1/8)	26.196 (1 1/8)	55.7	28 200	40 100
23.6(0.93)	38.100 (1 1/2)	9.525 (3/8)	0.794 (1/32)	4.762 (3/16)	3.969 (3/16)	7.938 (5/16)	1.588 (1/8)	26.196 (1 1/8)	55.7	28 200	40 100
26.8(1.06)	44.450 (1 3/4)	11.112 (7/16)	0.794 (1/32)	4.762 (3/16)	3.969 (3/16)	7.938 (5/16)	1.588 (1/8)	32.543 (1 1/8)	100	35 300	55 600
26.8(1.06)	44.450 (1 3/4)	11.112 (7/16)	0.794 (1/32)	4.762 (3/16)	3.969 (3/16)	7.938 (5/16)	1.588 (1/8)	32.543 (1 1/8)	100	35 300	55 600
33.5(1.32)	50.800 (2)	12.700 (1/2)	0.794 (1/32)	4.762 (3/16)	4.762 (3/16)	11.112 (7/16)	1.588 (1/8)	37.306 (1 1/2)	162	45 700	80 600
33.5(1.32)	50.800 (2)	12.700 (1/2)	0.794 (1/32)	4.762 (3/16)	4.762 (3/16)	11.112 (7/16)	1.588 (1/8)	37.306 (1 1/2)	162	45 700	80 600

1N=0.102kgf=0.2248lbs.
1mm=0.039 37inch

CAM FOLLOWERS

Inch Series Cam Followers Full Complement Type/With Screwdriver Slot

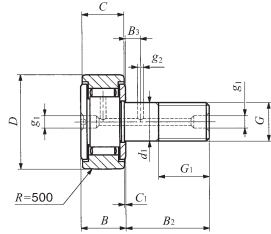

CR...VR

Stud dia. 4.826 – 31.750mm

Stud dia. mm (inch)	Identification number				Mass (Ref.) g	Boundary dimensions				
	Shield type		Sealed type			D	C	d ₁	G UNF	G ₁
	With crowned outer ring	With cylindrical outer ring	With crowned outer ring	With cylindrical outer ring						
4.826	CR 8 VR	CR 8 V	CR 8 VUUR	CR 8 VUU	9	12.700 (1/2)	8.731 (3/8)	4.826	No.10-32	6.350 (1/4)
	CR 8-1 VR	CR 8-1 V	CR 8-1 VUUR	CR 8-1 VUU	10	12.700 (1/2)	9.525 (3/8)	4.826	No.10-32	6.350 (1/4)
6.350 (1/4)	CR 10 VR	CR 10 V	CR 10 VUUR	CR 10 VUU	19	15.875 (5/8)	10.319 (3/8)	6.350 (1/4)	1/4 - 28	7.938 (5/16)
	CR 10-1 VR	CR 10-1 V	CR 10-1 VUUR	CR 10-1 VUU	21	15.875 (5/8)	11.112 (7/16)	6.350 (1/4)	1/4 - 28	7.938 (5/16)
9.525 (3/8)	CR 12 VR	CR 12 V	CR 12 VUUR	CR 12 VUU	36	19.050 (3/4)	12.700 (1/2)	9.525 (3/8)	3/8 - 24	9.525 (3/8)
	CR 14 VR	CR 14 V	CR 14 VUUR	CR 14 VUU	47	22.225 (7/8)	12.700 (1/2)	9.525 (3/8)	3/8 - 24	9.525 (3/8)
11.112 (7/16)	CR 16 VR	CR 16 V	CR 16 VUUR	CR 16 VUU	74	25.400 (1)	15.875 (5/8)	11.112 (7/16)	7/16 - 20	12.700 (1/2)
	CR 18 VR	CR 18 V	CR 18 VUUR	CR 18 VUU	85	28.575 (1 1/8)	15.875 (5/8)	11.112 (7/16)	7/16 - 20	12.700 (1/2)
12.700 (1/2)	CR 20 VR	CR 20 V	CR 20 VUUR	CR 20 VUU	137	31.750 (1 1/4)	19.050 (3/4)	12.700 (1/2)	1/2 - 20	15.875 (5/8)
	CR 22 VR	CR 22 V	CR 22 VUUR	CR 22 VUU	160	34.925 (1 3/8)	19.050 (3/4)	12.700 (1/2)	1/2 - 20	15.875 (5/8)
15.875 (5/8)	CR 24 VR	CR 24 V	CR 24 VUUR	CR 24 VUU	230	38.100 (1 1/2)	22.225 (7/8)	15.875 (5/8)	5/8 - 18	19.050 (3/4)
	CR 26 VR	CR 26 V	CR 26 VUUR	CR 26 VUU	265	41.275 (1 5/8)	22.225 (7/8)	15.875 (5/8)	5/8 - 18	19.050 (3/4)
19.050 (3/4)	CR 28 VR	CR 28 V	CR 28 VUUR	CR 28 VUU	372	44.450 (1 3/4)	25.400 (1)	19.050 (3/4)	3/4 - 16	22.225 (7/8)
	CR 30 VR	CR 30 V	CR 30 VUUR	CR 30 VUU	418	47.625 (1 7/8)	25.400 (1)	19.050 (3/4)	3/4 - 16	22.225 (7/8)
22.225 (7/8)	CR 32 VR	CR 32 V	CR 32 VUUR	CR 32 VUU	627	50.800 (2)	31.750 (1 1/4)	22.225 (7/8)	7/8 - 14	25.400 (1)
	CR 36 VR	CR 36 V	CR 36 VUUR	CR 36 VUU	759	57.150 (2 1/4)	31.750 (1 1/4)	22.225 (7/8)	7/8 - 14	25.400 (1)
31.750 (1 1/4)	—	—	—	CR 48 VUU	1960	76.200 (3)	44.450 (1 3/4)	31.750 (1 1/4)	1 1/4 - 12	31.750 (1 1/4)

Remarks 1. Models with a stud diameter d_1 of 6.35 mm or less (marked *) are provided with an oil hole on the stud head only. Other models are provided with one oil hole each on the head, outside surface and end surface of the stud.
2. Provided with prepacked grease.

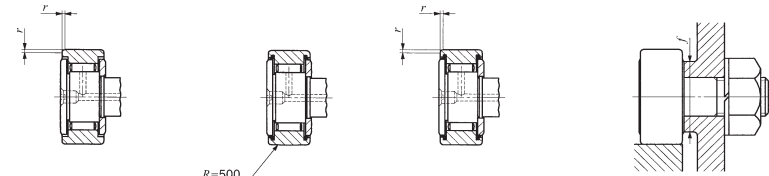

CR...V

CR...VUUR

CR...VUU

Boundary dimensions mm(inch)							Mounting dimension f Min. mm(inch)	Maximum tightening torque N·m	Basic dynamic load rating C N	Basic static load rating C ₀ N
B max	B ₂	B ₃	C ₁	g ₁	g ₂	r				
10.2(0.40)	12.700(1/2)	— (—)	0.794(3/32)	*3.175(1/8)	— (—)	0.397(1/16)	8.334(1/3)	1.4	4 260	4 750
10.9(0.43)	15.875(5/8)	— (—)	0.794(3/32)	*3.175(1/8)	— (—)	0.397(1/16)	8.334(1/3)	1.4	4 710	5 410
11.8(0.46)	15.875(5/8)	— (—)	0.794(3/32)	*3.175(1/8)	— (—)	0.397(1/16)	11.509(9/16)	3.4	5 830	7 660
12.5(0.49)	19.050(3/4)	— (—)	0.794(3/32)	*3.175(1/8)	— (—)	0.397(1/16)	11.509(9/16)	3.4	6 340	8 530
14.2(0.56)	22.225(7/8)	6.350(1/4)	0.794(3/32)	4.762(3/16)	2.381(3/32)	0.794(3/32)	13.494(1 1/8)	10.8	8 710	12 300
14.2(0.56)	22.225(7/8)	6.350(1/4)	0.794(3/32)	4.762(3/16)	2.381(3/32)	0.794(3/32)	15.081(1 1/2)	10.8	8 710	12 300
17.3(0.68)	25.400(1)	6.350(1/4)	0.794(3/32)	4.762(3/16)	3.175(1/8)	1.191(3/64)	17.859(5/8)	17.4	13 100	22 700
17.3(0.68)	25.400(1)	6.350(1/4)	0.794(3/32)	4.762(3/16)	3.175(1/8)	1.588(3/16)	19.050(3/4)	17.4	13 100	22 700
20.4(0.80)	31.750(1 1/4)	7.938(5/16)	0.794(3/32)	4.762(3/16)	3.175(1/8)	1.588(3/16)	21.828(5/8)	27.7	23 600	31 700
20.4(0.80)	31.750(1 1/4)	7.938(5/16)	0.794(3/32)	4.762(3/16)	3.175(1/8)	1.588(3/16)	21.828(5/8)	27.7	23 600	31 700
23.6(0.93)	38.100(1 1/2)	9.525(3/8)	0.794(3/32)	4.762(3/16)	3.969(3/16)	1.588(3/16)	26.196(1 1/8)	55.7	28 200	40 100
23.6(0.93)	38.100(1 1/2)	9.525(3/8)	0.794(3/32)	4.762(3/16)	3.969(3/16)	1.588(3/16)	26.196(1 1/8)	55.7	28 200	40 100
26.8(1.06)	44.450(1 3/4)	11.112(7/16)	0.794(3/32)	4.762(3/16)	3.969(3/16)	1.588(3/16)	32.543(1 3/8)	100	35 300	55 600
26.8(1.06)	44.450(1 3/4)	11.112(7/16)	0.794(3/32)	4.762(3/16)	3.969(3/16)	1.588(3/16)	32.543(1 3/8)	100	35 300	55 600
33.5(1.32)	50.800(2)	12.700(1/2)	0.794(3/32)	4.762(3/16)	4.762(3/16)	1.588(3/16)	37.306(1 1/2)	162	45 700	80 600
33.5(1.32)	50.800(2)	12.700(1/2)	0.794(3/32)	4.762(3/16)	4.762(3/16)	1.588(3/16)	37.306(1 1/2)	162	45 700	80 600
46.4(1.83)	63.500(2 1/2)	15.875(5/8)	1.588(3/16)	6.350(1/4)	4.762(3/16)	2.381(3/32)	51.991(2 3/8)	500	77 600	172 000

1N=0.102kgf=0.2248lbs.
1mm=0.03937inch

CAM FOLLOWERS

Inch Series Heavy Duty Cam Followers Full Complement Type/With Hexagon Hole

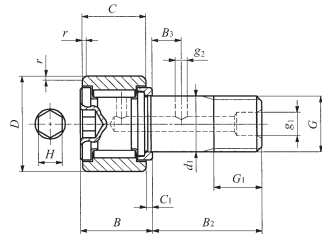

CRH...VB

Stud dia. 6.350 – 50.800mm

Stud dia. mm (inch)	Identification number		Mass (Ref.) g	Boundary dimensions mm (inch)					
	Shield type	Sealed type		D	C	d ₁	G UNF	G ₁	B max
6.350 (1/4)	CRH 8-1 VB	CRH 8-1 VBUU	12	12.700 (1/2)	9.525 (3/8)	6.350 (1/4)	1/4-28	6.350 (1/4)	11.1(0.44)
	CRH 9 VB	CRH 9 VBUU	15	14.288 (9/16)	9.525 (3/8)	6.350 (1/4)	1/4-28	6.350 (1/4)	11.1(0.44)
7.938 (5/16)	CRH 10-1 VB	CRH 10-1 VBUU	23	15.875 (5/8)	11.112 (7/16)	7.938 (5/16)	5/16-24	7.938 (5/16)	12.8(0.50)
	CRH 11 VB	CRH 11 VBUU	27	17.462 (11/16)	11.112 (7/16)	7.938 (5/16)	5/16-24	7.938 (5/16)	12.8(0.50)
11.112 (7/16)	CRH 12 VB	CRH 12 VBUU	39	19.050 (3/4)	12.700 (1/2)	11.112 (7/16)	3/8-20	9.525 (3/8)	14.6(0.57)
	CRH 14 VB	CRH 14 VBUU	49	22.225 (7/8)	12.700 (1/2)	11.112 (7/16)	3/8-20	9.525 (3/8)	14.6(0.57)
15.875 (5/8)	CRH 16 VB	CRH 16 VBUU	93	25.400 (1)	15.875 (5/8)	15.875 (5/8)	5/8-18	12.700 (1/2)	17.9(0.70)
	CRH 18 VB	CRH 18 VBUU	109	28.575 (1 1/8)	15.875 (5/8)	15.875 (5/8)	5/8-18	12.700 (1/2)	17.9(0.70)
19.050 (3/4)	CRH 20 VB	CRH 20 VBUU	176	31.750 (1 1/4)	19.050 (3/4)	19.050 (3/4)	3/4-16	15.875 (5/8)	21.0(0.83)
	CRH 22 VB	CRH 22 VBUU	200	34.925 (1 3/8)	19.050 (3/4)	19.050 (3/4)	3/4-16	15.875 (5/8)	21.0(0.83)
22.225 (7/8)	CRH 24 VB	CRH 24 VBUU	296	38.100 (1 1/2)	22.225 (7/8)	22.225 (7/8)	7/8-14	19.050 (3/4)	24.3(0.96)
	CRH 26 VB	CRH 26 VBUU	329	41.275 (1 5/8)	22.225 (7/8)	22.225 (7/8)	7/8-14	19.050 (3/4)	24.3(0.96)
25.400 (1)	CRH 28 VB	CRH 28 VBUU	463	44.450 (1 3/4)	25.400 (1)	25.400 (1)	1-14 UNS	22.225 (7/8)	27.4(1.08)
	CRH 30 VB	CRH 30 VBUU	508	47.625 (1 7/8)	25.400 (1)	25.400 (1)	1-14 UNS	22.225 (7/8)	27.4(1.08)
28.575 (1 1/8)	CRH 32 VB	CRH 32 VBUU	722	50.800 (2)	31.750 (1 1/4)	28.575 (1 1/8)	1 1/8-12	25.400 (1)	34.2(1.35)
	CRH 36 VB	CRH 36 VBUU	858	57.150 (2 1/8)	31.750 (1 1/4)	28.575 (1 1/8)	1 1/8-12	25.400 (1)	34.2(1.35)
31.750 (1 1/4)	CRH 40 VB	CRH 40 VBUU	1260	63.500 (2 1/2)	38.100 (1 1/2)	31.750 (1 1/4)	1 1/4-12	28.575 (1 1/8)	40.0(1.57)
	CRH 44 VB	CRH 44 VBUU	1460	69.850 (2 3/4)	38.100 (1 1/2)	31.750 (1 1/4)	1 1/4-12	28.575 (1 1/8)	40.0(1.57)
38.100 (1 1/2)	CRH 48 VB	CRH 48 VBUU	2 100	76.200 (3)	44.450 (1 3/4)	38.100 (1 1/2)	1 1/2-12	31.750 (1 1/4)	46.4(1.83)
	CRH 52 VB	CRH 52 VBUU	2 380	82.550 (3 1/4)	44.450 (1 3/4)	38.100 (1 1/2)	1 1/2-12	31.750 (1 1/4)	46.4(1.83)
44.450 (1 3/4)	CRH 56 VB	CRH 56 VBUU	3 240	88.900 (3 1/2)	50.800 (2)	44.450 (1 3/4)	1 3/4-12 UN	34.925 (1 3/8)	52.8(2.08)
50.800 (2)	CRH 64 VB	CRH 64 VBUU	4 960	101.600 (4)	57.150 (2 1/8)	50.800 (2)	2-12 UN	38.100 (1 1/2)	59.4(2.34)

Remarks1. Models with a stud diameter d_1 of 7.938 mm or less have no oil hole. Other models are provided with one oil hole each on the outside surface and end surface of the stud.
2. Provided with prepacked grease.

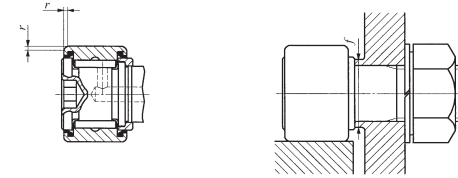

CRH...VBUU

Boundary dimensions mm (inch)							Mounting dimension f Min. mm (inch)	Maximum tightening torque N-m	Basic dynamic load rating C N	Basic static load rating C ₀ N
B ₂	B ₃	C ₁	g ₁	g ₂	H	r				
15.875 (5/8)	- (-)	0.794 (5/16)	- (-)	- (-)	3.175 (1/8)	0.397 (1/16)	8.334 (1/2)	3.4	4 710	5 410
15.875 (5/8)	- (-)	0.794 (5/16)	- (-)	- (-)	3.175 (1/8)	0.397 (1/16)	8.334 (1/2)	3.4	4 710	5 410
19.050 (3/4)	- (-)	0.794 (5/16)	- (-)	- (-)	3.175 (1/8)	0.397 (1/16)	11.112 (7/16)	6.8	6 340	8 530
19.050 (3/4)	- (-)	0.794 (5/16)	- (-)	- (-)	3.175 (1/8)	0.397 (1/16)	11.112 (7/16)	6.8	6 340	8 530
22.225 (7/8)	6.350 (1/4)	0.794 (5/16)	4.762 (3/16)	2.381 (3/32)	4.762 (3/16)	0.794 (5/16)	13.494 (1/2)	17.6	8 710	12 300
22.225 (7/8)	6.350 (1/4)	0.794 (5/16)	4.762 (3/16)	2.381 (3/32)	4.762 (3/16)	0.794 (5/16)	13.494 (1/2)	17.6	8 710	12 300
25.400 (1)	6.350 (1/4)	1.588 (1/8)	4.762 (3/16)	2.381 (3/32)	6.350 (1/4)	1.191 (3/32)	18.256 (3/4)	57.8	13 100	22 700
25.400 (1)	6.350 (1/4)	1.588 (1/8)	4.762 (3/16)	2.381 (3/32)	6.350 (1/4)	1.588 (1/8)	18.256 (3/4)	57.8	13 100	22 700
31.750 (1 1/4)	7.938 (5/16)	1.588 (1/8)	4.762 (3/16)	2.381 (3/32)	6.350 (1/4)	1.588 (1/8)	24.209 (1)	103	23 600	31 700
31.750 (1 1/4)	7.938 (5/16)	1.588 (1/8)	4.762 (3/16)	2.381 (3/32)	6.350 (1/4)	1.588 (1/8)	24.209 (1)	103	23 600	31 700
38.100 (1 1/2)	9.525 (3/8)	1.588 (1/8)	4.762 (3/16)	2.381 (3/32)	7.938 (5/16)	1.588 (1/8)	26.988 (1 1/8)	162	28 200	40 100
38.100 (1 1/2)	9.525 (3/8)	1.588 (1/8)	4.762 (3/16)	2.381 (3/32)	7.938 (5/16)	1.588 (1/8)	26.988 (1 1/8)	162	28 200	40 100
44.450 (1 3/4)	11.112 (7/16)	1.588 (1/8)	4.762 (3/16)	2.381 (3/32)	7.938 (5/16)	1.588 (1/8)	32.941 (1 1/8)	258	35 300	55 600
44.450 (1 3/4)	11.112 (7/16)	1.588 (1/8)	4.762 (3/16)	2.381 (3/32)	7.938 (5/16)	1.588 (1/8)	32.941 (1 1/8)	258	35 300	55 600
50.800 (2)	12.700 (1/2)	1.588 (1/8)	4.762 (3/16)	3.175 (1/8)	11.112 (7/16)	1.588 (1/8)	37.306 (1 1/2)	356	45 700	80 600
50.800 (2)	12.700 (1/2)	1.588 (1/8)	4.762 (3/16)	3.175 (1/8)	11.112 (7/16)	1.588 (1/8)	37.306 (1 1/2)	356	45 700	80 600
57.150 (2 1/8)	14.288 (9/16)	1.588 (1/8)	4.762 (3/16)	3.175 (1/8)	12.700 (1/2)	2.381 (3/32)	40.878 (1 3/8)	500	61 400	116 000
57.150 (2 1/8)	14.288 (9/16)	1.588 (1/8)	4.762 (3/16)	3.175 (1/8)	12.700 (1/2)	2.381 (3/32)	40.878 (1 3/8)	500	61 400	116 000
63.500 (2 1/2)	15.875 (5/8)	1.588 (1/8)	6.350 (1/4)	3.175 (1/8)	19.050 (3/4)	2.381 (3/32)	51.991 (2 1/8)	892	77 600	172 000
63.500 (2 1/2)	15.875 (5/8)	1.588 (1/8)	6.350 (1/4)	3.175 (1/8)	19.050 (3/4)	2.381 (3/32)	51.991 (2 1/8)	892	77 600	172 000
69.850 (2 3/4)	17.462 (1 1/8)	1.588 (1/8)	6.350 (1/4)	3.175 (1/8)	19.050 (3/4)	2.381 (3/32)	59.928 (2 3/8)	1 450	111 000	239 000
88.900 (3 1/2)	19.050 (3/4)	1.588 (1/8)	6.350 (1/4)	3.175 (1/8)	19.050 (3/4)	2.381 (3/32)	64.691 (2 5/8)	2 190	142 000	317 000

1N=0.102kgf=0.2248lbs.
1mm=0.03937inch

CAM FOLLOWERS

Inch Series Heavy Duty Cam Followers Full Complement Type/With Screwdriver Slot

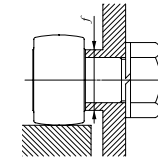
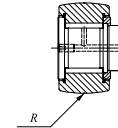
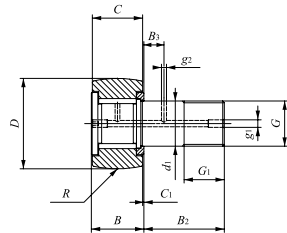

Stud dia. 6.350 – 50.800mm

CRH...VR

Stud dia. mm (inch)	Identification number		Mass (Ref.) g	Boundary dimensions mm (inch)						
	Shield type	Sealed type		D	C	d ₁	G UNF	G ₁	B max	
6.350 (1/4)	CRH 8-1 VR	CRH 8-1 VUUR	12	12.700 (1/2)	.525 (3/8)	6.350 (1/4)	1/4-28	.350 (3/8)	11.1(0.44)	
	CRH 9 VR	CRH 9 VUUR	1	14.288 (3/8)	.525 (3/8)	6.350 (1/4)	1/4-28	.350 (3/8)	11.1(0.44)	
7.938 (3/16)	CRH 10-1 VR	CRH 10-1 VUUR	23	18.5 (3/4)	11.112 (3/8)	7.938 (3/16)	3/8-24	.938 (3/8)	12.8(0.50)	
	CRH 11 VR	CRH 11 VUUR	2	14.2 (1/2)	11.112 (3/8)	7.938 (3/16)	3/8-24	.938 (3/8)	12.8(0.50)	
11.112 (7/16)	CRH 12 VR	CRH 12 VUUR	3	10.0 (1)	12.700 (1/2)	11.112 (3/8)	1/2-20	.525 (3/8)	14.6(0.57)	
	CRH 14 VR	CRH 14 VUUR	4	11.4 (1/2)	12.700 (1/2)	11.112 (3/8)	1/2-20	.525 (3/8)	14.6(0.57)	
15.875 (5/8)	CRH 16 VR	CRH 16 VUUR	93	24.00 (1)	1.875 (3/8)	15.87 (3/8)	3/8-18	12.700 (1/2)	17.9(0.70)	
	CRH 18 VR	CRH 18 VUUR	10	28.5 (1 1/8)	1.875 (3/8)	15.87 (3/8)	3/8-18	12.700 (1/2)	17.9(0.70)	
19.050 (3/4)	CRH 20 VR	CRH 20 VUUR	17	31.7 (1 1/4)	1.050 (3/4)	19.050 (3/4)	1/2-16	1.875 (3/8)	21.0(0.83)	
	CRH 22 VR	CRH 22 VUUR	200	34.925 (1 3/8)	1.050 (3/4)	19.050 (3/4)	1/2-16	1.875 (3/8)	21.0(0.83)	
22.225 (7/8)	CRH 24 VR	CRH 24 VUUR	29	38.100 (1 1/2)	22.225 (7/8)	22.22 (7/8)	3/8-14	1.050 (3/4)	24.3(0.96)	
	CRH 26 VR	CRH 26 VUUR	32	41.2 (1 5/8)	22.225 (7/8)	22.22 (7/8)	3/8-14	1.050 (3/4)	24.3(0.96)	
25.400 (1)	CRH 28 VR	CRH 28 VUUR	463	44.4 (1 3/4)	2.400 (1)	25.400 (1)	1-14 UNS	22.225 (7/8)	27.4(1.08)	
	CRH 30 VR	CRH 30 VUUR	08	46.25 (1 7/8)	2.400 (1)	25.400 (1)	1-14 UNS	22.225 (7/8)	27.4(1.08)	
28.575 (1 1/8)	CRH 32 VR	CRH 32 VUUR	22	50.800 (2)	31.750 (1 1/4)	28.57 (1 1/8)	1 3/8-12	2.400 (1)	34.2(1.35)	
	CRH 36 VR	CRH 36 VUUR	858	51.0 (2 1/8)	31.750 (1 1/4)	28.57 (1 1/8)	1 3/8-12	2.400 (1)	34.2(1.35)	
31.750 (1 1/4)	CRH 40 VR	CRH 40 VUUR	1260	63.500 (2 1/2)	38.100 (1 1/2)	31.750 (1 1/4)	1 1/4-12	28.575 (1 1/8)	40.0(1.57)	
	CRH 44 VR	CRH 44 VUUR	1460	68.0 (2 3/4)	38.100 (1 1/2)	31.750 (1 1/4)	1 1/4-12	28.575 (1 1/8)	40.0(1.57)	
38.100 (1 1/2)	CRH 48 VR	CRH 48 VUUR	2100	72.00 (3)	44.450 (1 3/4)	38.100 (1 1/2)	1 1/2-12	31.750 (1 1/4)	46.4(1.83)	
	CRH 52 VR	CRH 52 VUUR	2380	82.5 (3 1/8)	44.450 (1 3/4)	38.100 (1 1/2)	1 1/2-12	31.750 (1 1/4)	46.4(1.83)	
44.450 (1 3/4)	CRH 56 VR	CRH 56 VUUR	3240	88.900 (3 1/2)	50.800 (2)	44.450 (1 3/4)	1 3/4-12 UN	34.925 (1 3/8)	52.8(2.08)	
50.800 (2)	CRH 64 VR	CRH 64 VUUR	460	101.600 (4)	50.800 (2)	50.800 (2)	2-12 UN	38.100 (1 1/2)	59.4(2.34)	

CRH...VUUR

Boundary dimensions mm (inch)						Mounting dimension f mm (inch)	Maximum tightening torque N-m	Basic dynamic load rating N	Basic static load rating N
B ₂	B ₃	C ₁	g ₁	g ₂	R				
15.875 (3/8)	— (-)	0.794 (3/16)	*3.17 (1/8)	— (-)	180 (7)	8.334 (23/64)	3.4	4 710	410
15.875 (3/8)	— (-)	0.794 (3/16)	*3.175 (1/8)	— (-)	180 (7)	8.334 (23/64)	3.4	4 710	5 410
19.050 (3/4)	— (-)	0.794 (3/16)	*3.175 (1/8)	— (-)	200 (8)	11.112 (7/16)	6.8	6 340	8 530
19.050 (3/4)	— (-)	0.794 (3/16)	*3.175 (1/8)	— (-)	200 (8)	11.112 (7/16)	6.8	6 340	8 530
22.225 (7/8)	6.350 (1/4)	0.794 (3/16)	4.762 (3/16)	2.381 (3/32)	250 (10)	13.494 (11/16)	17.6	8 710	12 300
22.225 (7/8)	6.350 (1/4)	0.794 (3/16)	4.762 (3/16)	2.381 (3/32)	250 (10)	13.494 (11/16)	17.6	8 710	12 300
25.400 (1)	6.350 (1/4)	1.588 (3/16)	4.762 (3/16)	2.381 (3/32)	300 (12)	18.256 (3/4)	57.8	13 100	22 700
25.400 (1)	6.350 (1/4)	1.588 (3/16)	4.762 (3/16)	2.381 (3/32)	300 (12)	18.256 (3/4)	57.8	13 100	22 700
31.750 (1 1/4)	7.938 (3/16)	1.588 (3/16)	4.762 (3/16)	2.381 (3/32)	360 (14)	24.209 (9/16)	103	23 600	31 700
31.750 (1 1/4)	7.938 (3/16)	1.588 (3/16)	4.762 (3/16)	2.381 (3/32)	360 (14)	24.209 (9/16)	103	23 600	31 700
38.100 (1 1/2)	9.525 (3/8)	1.588 (3/16)	4.762 (3/16)	2.381 (3/32)	500 (20)	26.988 (1 1/8)	162	28 200	40 100
38.100 (1 1/2)	9.525 (3/8)	1.588 (3/16)	4.762 (3/16)	2.381 (3/32)	500 (20)	26.988 (1 1/8)	162	28 200	40 100
44.450 (1 3/4)	11.112 (7/16)	1.588 (3/16)	4.762 (3/16)	2.381 (3/32)	500 (20)	32.941 (1 1/4)	258	35 300	55 600
44.450 (1 3/4)	11.112 (7/16)	1.588 (3/16)	4.762 (3/16)	2.381 (3/32)	500 (20)	32.941 (1 1/4)	258	35 300	55 600
50.800 (2)	12.700 (1/2)	1.588 (3/16)	4.762 (3/16)	3.175 (1/8)	600 (24)	37.306 (1 5/16)	356	45 700	80 600
50.800 (2)	12.700 (1/2)	1.588 (3/16)	4.762 (3/16)	3.175 (1/8)	600 (24)	37.306 (1 5/16)	356	45 700	80 600
57.150 (2 1/4)	14.288 (3/8)	1.588 (3/16)	4.762 (3/16)	3.175 (1/8)	760 (30)	40.878 (1 3/4)	500	61 400	116 000
57.150 (2 1/4)	14.288 (3/8)	1.588 (3/16)	4.762 (3/16)	3.175 (1/8)	760 (30)	40.878 (1 3/4)	500	61 400	116 000
63.500 (2 1/2)	15.875 (3/4)	1.588 (3/16)	6.350 (1/4)	3.175 (1/8)	760 (30)	51.991 (2 1/4)	892	77 600	172 000
63.500 (2 1/2)	15.875 (3/4)	1.588 (3/16)	6.350 (1/4)	3.175 (1/8)	760 (30)	51.991 (2 1/4)	892	77 600	172 000
69.850 (2 3/4)	17.462 (3/4)	1.588 (3/16)	6.350 (1/4)	3.175 (1/8)	760 (30)	59.928 (2 3/8)	1 450	111 000	239 000
88.900 (3 1/2)	19.050 (3/4)	1.588 (3/16)	6.350 (1/4)	3.175 (1/8)	760 (30)	64.691 (2 5/8)	2 190	142 000	317 000

Remarks 1. Models with a stud diameter d₁ of 7.938 mm or less (marked *) are provided with an oil hole on the stud head only. Other models are provided with one oil hole each on the head, outside surface and end surface of the stud.
2. Provided with prepacked grease.

1N=0.102kgf=0.248lb
1 m=0.039 7inch

CAM FOLLOWERS

Inch Series Heavy Duty Cam Followers Full Complement Type/With Screwdriver Slot

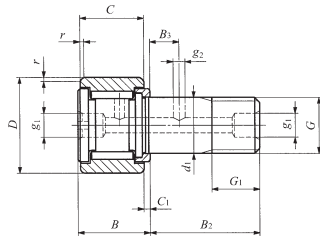

Stud dia. 6.350 – 50.800mm

CRH...V

Stud dia. mm (inch)	Identification number		Mass (Ref.) g	Boundary dimensions mm (inch)					
	Shield type	Sealed type		D	C	d ₁	G UNF	G ₁	B max
6.350 (1/4)	CRH 8-1 V	CRH 8-1 VUU	12	12.700 (1/2)	9.525 (3/8)	6.350 (1/4)	1/4-28	6.350 (1/4)	11.1(0.44)
	CRH 9 V	CRH 9 VUU	15	14.228 (5/8)	9.525 (3/8)	6.350 (1/4)	1/4-28	6.350 (1/4)	11.1(0.44)
7.938 (5/16)	CRH 10-1 V	CRH 10-1 VUU	23	15.875 (5/8)	11.112 (7/8)	7.938 (3/8)	3/8-24	7.938 (3/8)	12.8(0.50)
	CRH 11 V	CRH 11 VUU	27	17.462 (11/8)	11.112 (7/8)	7.938 (3/8)	3/8-24	7.938 (3/8)	12.8(0.50)
11.112 (7/16)	CRH 12 V	CRH 12 VUU	39	19.050 (3/4)	12.700 (1/2)	11.112 (7/8)	3/8-20	9.525 (3/8)	14.6(0.57)
	CRH 14 V	CRH 14 VUU	49	22.225 (7/8)	12.700 (1/2)	11.112 (7/8)	3/8-20	9.525 (3/8)	14.6(0.57)
15.875 (5/8)	CRH 16 V	CRH 16 VUU	93	25.400 (1)	15.875 (5/8)	15.875 (5/8)	3/8-18	12.700 (1/2)	17.9(0.70)
	CRH 18 V	CRH 18 VUU	109	28.575 (1 1/8)	15.875 (5/8)	15.875 (5/8)	3/8-18	12.700 (1/2)	17.9(0.70)
19.050 (3/4)	CRH 20 V	CRH 20 VUU	176	31.750 (1 1/4)	19.050 (3/4)	19.050 (3/4)	1/2-16	15.875 (5/8)	21.0(0.83)
	CRH 22 V	CRH 22 VUU	200	34.925 (1 3/8)	19.050 (3/4)	19.050 (3/4)	1/2-16	15.875 (5/8)	21.0(0.83)
22.225 (7/8)	CRH 24 V	CRH 24 VUU	296	38.100 (1 1/2)	22.225 (7/8)	22.225 (7/8)	3/8-14	19.050 (3/4)	24.3(0.96)
	CRH 26 V	CRH 26 VUU	329	41.275 (1 5/8)	22.225 (7/8)	22.225 (7/8)	3/8-14	19.050 (3/4)	24.3(0.96)
25.400 (1)	CRH 28 V	CRH 28 VUU	463	44.450 (1 3/4)	25.400 (1)	25.400 (1)	1-14 UNS	22.225 (7/8)	27.4(1.08)
	CRH 30 V	CRH 30 VUU	508	47.625 (1 7/8)	25.400 (1)	25.400 (1)	1-14 UNS	22.225 (7/8)	27.4(1.08)
28.575 (1 1/8)	CRH 32 V	CRH 32 VUU	722	50.800 (2)	31.750 (1 1/4)	28.575 (1 1/8)	1 1/8-12	25.400 (1)	34.2(1.35)
	CRH 36 V	CRH 36 VUU	858	57.150 (2 1/8)	31.750 (1 1/4)	28.575 (1 1/8)	1 1/8-12	25.400 (1)	34.2(1.35)
31.750 (1 1/4)	CRH 40 V	CRH 40 VUU	1260	63.500 (2 1/2)	38.100 (1 1/2)	31.750 (1 1/4)	1 1/4-12	28.575 (1 1/8)	40.0(1.57)
	CRH 44 V	CRH 44 VUU	1460	69.850 (2 3/4)	38.100 (1 1/2)	31.750 (1 1/4)	1 1/4-12	28.575 (1 1/8)	40.0(1.57)
38.100 (1 1/2)	CRH 48 V	CRH 48 VUU	2100	76.200 (3)	44.450 (1 3/4)	38.100 (1 1/2)	1 1/2-12	31.750 (1 1/4)	46.4(1.83)
	CRH 52 V	CRH 52 VUU	2380	82.550 (3 1/8)	44.450 (1 3/4)	38.100 (1 1/2)	1 1/2-12	31.750 (1 1/4)	46.4(1.83)
44.450 (1 3/4)	CRH 56 V	CRH 56 VUU	3240	88.900 (3 1/2)	50.800 (2)	44.450 (1 3/4)	1 3/4-12 UN	34.925 (1 3/8)	52.8(2.08)
50.800 (2)	CRH 64 V	CRH 64 VUU	4960	101.600 (4)	57.150 (2 1/8)	50.800 (2)	2-12 UN	38.100 (1 1/2)	59.4(2.34)

Remarks 1. Models with a stud diameter d_1 of 7.938 mm or less (marked *) are provided with an oil hole on the stud head only. Other models are provided with one oil hole each on the head, outside surface and end surface of the stud.
2. Provided with prepacked grease.

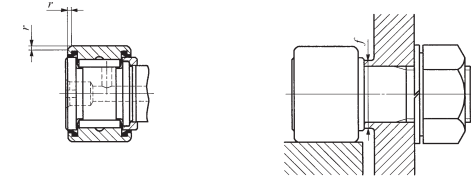

CRH...VUU

Boundary dimensions mm (inch)						Mounting dimension f Min. mm (inch)	Maximum tightening torque N-m	Basic dynamic load rating C N	Basic static load rating C ₀ N
B ₂	B ₃	C ₁	g ₁	g ₂	r				
15.875 (5/8)	— (—)	0.794 (1/8)	*3.175 (1/8)	— (—)	0.397 (1/8)	8.334 (1/2)	3.4	4 710	5 410
15.875 (5/8)	— (—)	0.794 (1/8)	*3.175 (1/8)	— (—)	0.397 (1/8)	8.334 (1/2)	3.4	4 710	5 410
19.050 (3/4)	— (—)	0.794 (1/8)	*3.175 (1/8)	— (—)	0.397 (1/8)	11.112 (7/8)	6.8	6 340	8 530
19.050 (3/4)	— (—)	0.794 (1/8)	*3.175 (1/8)	— (—)	0.397 (1/8)	11.112 (7/8)	6.8	6 340	8 530
22.225 (7/8)	6.350 (1/4)	0.794 (1/8)	4.762 (3/8)	2.381 (3/8)	0.794 (1/8)	13.494 (1 1/2)	17.6	8 710	12 300
22.225 (7/8)	6.350 (1/4)	0.794 (1/8)	4.762 (3/8)	2.381 (3/8)	0.794 (1/8)	13.494 (1 1/2)	17.6	8 710	12 300
25.400 (1)	6.350 (1/4)	1.588 (1/8)	4.762 (3/8)	2.381 (3/8)	1.191 (1/8)	18.256 (3/4)	57.8	13 100	22 700
25.400 (1)	6.350 (1/4)	1.588 (1/8)	4.762 (3/8)	2.381 (3/8)	1.588 (1/8)	18.256 (3/4)	57.8	13 100	22 700
31.750 (1 1/4)	7.938 (3/8)	1.588 (1/8)	4.762 (3/8)	2.381 (3/8)	1.588 (1/8)	24.209 (1 1/4)	103	23 600	31 700
31.750 (1 1/4)	7.938 (3/8)	1.588 (1/8)	4.762 (3/8)	2.381 (3/8)	1.588 (1/8)	24.209 (1 1/4)	103	23 600	31 700
38.100 (1 1/2)	9.525 (3/8)	1.588 (1/8)	4.762 (3/8)	2.381 (3/8)	1.588 (1/8)	26.988 (1 1/8)	162	28 200	40 100
38.100 (1 1/2)	9.525 (3/8)	1.588 (1/8)	4.762 (3/8)	2.381 (3/8)	1.588 (1/8)	26.988 (1 1/8)	162	28 200	40 100
44.450 (1 3/4)	11.112 (7/8)	1.588 (1/8)	4.762 (3/8)	2.381 (3/8)	1.588 (1/8)	32.941 (1 1/4)	258	35 300	55 600
44.450 (1 3/4)	11.112 (7/8)	1.588 (1/8)	4.762 (3/8)	2.381 (3/8)	1.588 (1/8)	32.941 (1 1/4)	258	35 300	55 600
50.800 (2)	12.700 (1/2)	1.588 (1/8)	4.762 (3/8)	3.175 (1/8)	1.588 (1/8)	37.306 (1 1/2)	356	45 700	80 600
50.800 (2)	12.700 (1/2)	1.588 (1/8)	4.762 (3/8)	3.175 (1/8)	1.588 (1/8)	37.306 (1 1/2)	356	45 700	80 600
57.150 (2 1/8)	14.288 (5/8)	1.588 (1/8)	4.762 (3/8)	3.175 (1/8)	2.381 (3/8)	40.878 (1 5/8)	500	61 400	116 000
57.150 (2 1/8)	14.288 (5/8)	1.588 (1/8)	4.762 (3/8)	3.175 (1/8)	2.381 (3/8)	40.878 (1 5/8)	500	61 400	116 000
63.500 (2 1/2)	15.875 (5/8)	1.588 (1/8)	6.350 (1/4)	3.175 (1/8)	2.381 (3/8)	51.991 (2 1/8)	892	77 600	172 000
63.500 (2 1/2)	15.875 (5/8)	1.588 (1/8)	6.350 (1/4)	3.175 (1/8)	2.381 (3/8)	51.991 (2 1/8)	892	77 600	172 000
69.850 (2 3/4)	17.462 (1 1/8)	1.588 (1/8)	6.350 (1/4)	3.175 (1/8)	2.381 (3/8)	59.928 (2 3/8)	1 450	111 000	239 000
88.900 (3 1/2)	19.050 (3/4)	1.588 (1/8)	6.350 (1/4)	3.175 (1/8)	2.381 (3/8)	64.691 (2 5/8)	2 190	142 000	317 000

ROLLER FOLLOWERS

- Separable Roller Followers
- Non-separable Roller Followers
- Heavy Duty Type Roller Followers



Structure and Features

Roller Followers are bearings designed for outer ring rotation, in which needle rollers are incorporated in a thick walled outer ring. Both crowned and cylindrical outer rings are available. The outer rings run directly on mating track surfaces, and the crowned outer ring is effective in relieving the edge load caused by mounting errors. The cylindrical outer ring, on the other hand, has a large contact area with the mating track surface and is suitable for applications involving large loads or low track surface hardness.

In Roller Followers, there are two types of bearings available, the caged type and the full complement type. The caged type is useful for applications at high-speed rotation. The full complement type, on the other hand, is suitable for heavy-load applications at low-speed rotation or oscillating motions.

Roller Followers include separable and non-separable types. Also, in addition to the open type, shield type and sealed type are available. The clearances between the side plates and outer ring of the shield type are narrow, and form labyrinths. In the sealed type, special synthetic rubber seals are assembled in these clearances, and they are effective in preventing penetration of dust and dirt.

These bearings are available in a variety of types to suit almost any kind of application. They are widely used for cam mechanisms and for linear motions of conveying equipment.

Structures of Roller Followers

Structure of Separable Roller Follower

NAST...R

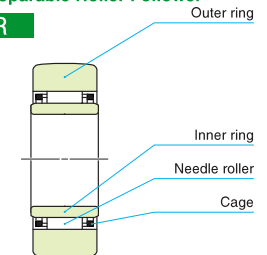

Structure of Separable Roller Follower

NAST...ZZ

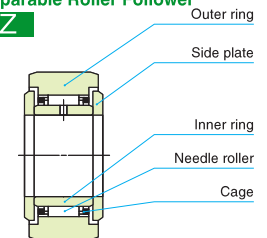

Structure of Non-separable Roller Follower

NART...VUUR

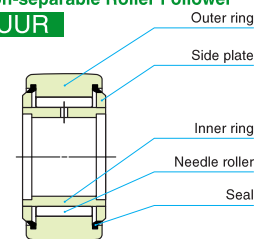

Structure of Heavy Duty Type Roller Follower

NURT...R

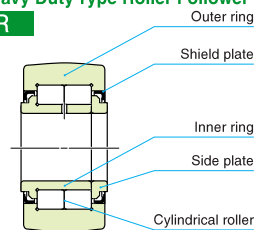

I

NAST
NART
NURT

Types

In Roller Followers, types shown in Table 1 are available.

Table 1 Type of Roller Followers

Type			With cage		Full complement type		
			Crowned outer ring	Cylindrical outer ring	Crowned outer ring	Cylindrical outer ring	
Metric series	Separable Roller Followers RNAS T, NAST	Without inner ring	Open type	RNAS T... R	RNAS T	—	—
		With inner ring	Open type	NAST... R	NAST	—	—
			Shield type	NAST... ZZ R	NAST... ZZ	—	—
	Non-separable Roller Followers NART	Shield type		NART... ZZUUR	NAST... ZZUU	—	—
				NART... V R	NART... VUUR	—	—
		Sealed type	NART... UUR	—	NART... VUUR	—	—
Heavy Duty Type Roller Followers NURT	Shield type		—	—	NURT... R	NURT	
			—	—	CRY... V R	CRY... V	
Inch series	Non-separable Roller Followers CRY	Shield type	—	—	CRY... VUUR	CRY... VUU	
		Sealed type	—	—	—	—	

Separable Roller Followers

These bearings are assembled by combining an outer ring, inner ring and Needle Roller Cage, which can be separated from one another. Thus, handling is easy. Oil lubrication is also easy, making them suitable for high-speed rotations.

There are two types: type without inner ring RNAST and type with inner ring NAST. The type with inner ring includes open type, shield type, and sealed type.

Non-separable Roller Followers

These non-separable type bearings have side plates fixed on both sides of the inner ring, and include the caged type and the full complement type. Both shield type and sealed type are available.

Inch series Non-separable Roller Followers are full complement type bearings and their surface is treated with black oxide surface treatment.

Heavy Duty Type Roller Followers

These full complement type bearings incorporate cylindrical rollers in the outer ring in two rows and can withstand large radial loads and some axial loads. These bearings are shield type with non-separable structure.

Identification Number

Some examples of the identification number of Roller Followers are shown below.

Examples of identification number

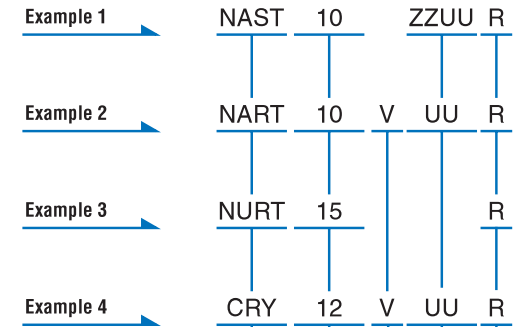

Model code			
Metric series	RNAS T NAST	Separable Roller Follower	Without inner ring With inner ring
	NART	Non-separable Roller Follower	
	NURT	Heavy Duty Type Roller Follower	
	CRY	Non-separable Roller Follower	
Size			
The size indicates the bore diameter of the inner ring. (unit: mm) In the inch series, the bore diameter is indicated in units of 1/16 inch.			
Roller guide method			
No symbol	With cage		
V	Full complement type		
Seal structure (Separable Roller Follower)			
No symbol	Open type		
ZZ	Shield type		
ZZUU	Sealed type		
Seal structure (Other Roller Follower)			
No symbol	Shield type		
UU	Sealed type		
Shape of outer ring outside surface			
R	With crowned outer ring		
No symbol	With cylindrical outer ring		

I

NAST
NURT

Accuracy

Dimensional accuracy and rotational accuracy of Roller Followers are based on Tables 2, 3 and 4. Tolerances for the smallest single roller set bore diameter of Separable Roller Followers are shown in Table 5. Roller Followers with special accuracy can also be manufactured.

Table 2 Tolerances

unit: μm

Dimensions and symbols		Series	Metric series		Inch series	
			Crowned outer ring	Cylindrical outer ring	Crowned outer ring	Cylindrical outer ring
Bore dia. of inner ring d		$d \leq 19.05$	See Table 3.		+ 5 - 10	+ 5 - 10
		$19.05 < d$			+ 2 - 12	
Outside dia. of outer ring D		0 - 50	See Table 4.	0 - 50	0 - 25	
Width of outer ring C		0 - 120		0 - 130		
Width of inner ring B		Separable Roller Follower 0 - 120		-		
Width of bearing B		Non-separable Roller Follower		h12	-	+ 130 - 250
		Heavy Duty Type Roller Follower				
Roller set bore dia. F_w		Separable Roller Follower		See Table 5.		-

Table 3 Tolerances and allowable values of inner rings (Metric series)

unit: μm

d Nominal bore dia. mm		Δ_{dmp} Single plane mean bore dia. deviation		V_{dp} Bore dia. variation in a single radial plane	V_{dmp} Mean bore dia. variation	K_{ia} Radial runout of assembled bearing inner ring	V_{Bs} Width variation
Over	Incl.	High	Low	(Max.)	(Max.)	(Max.)	(Max.)
2.5	10	0	- 8	10	6	10	15
10	18	0	- 8	10	6	10	20
18	30	0	- 10	13	8	13	20
30	50	0	- 12	15	9	15	20

Table 4 Tolerances and allowable values of outer rings (Metric series)

unit: μm

D Nominal outside dia. of outer ring mm		Δ_{Dmp} Single plane mean outside dia. deviation		$V_{Dp}^{(1)}$ Outside dia. variation in a single radial plane	$V_{Dmp}^{(1)}$ Mean outside dia. variation	$K_{ea}^{(1)}$ Radial runout of assembled bearing outer ring	V_{Cs} Width variation
Over	Incl.	High	Low	(Max.)	(Max.)	(Max.)	(Max.)
6	18	0	- 8	10	6	15	Same as the tolerance values of V_{Bs} for d of the inner of the same bearing
18	30	0	- 9	12	7	15	
30	50	0	- 11	14	8	20	
50	80	0	- 13	16	10	25	
80	120	0	- 15	19	11	35	

Note⁽¹⁾ Also applicable to the inch series.

Table 5 Tolerances of smallest single roller set bore diameter F_{ws} min

unit: μm

F_w Nominal roller set bore diameter mm		Δ_{Fws} min Deviation of smallest single roller set bore diameter	
Over	Incl.	High	Low
6	10	+ 22	+ 13
10	18	+ 27	+ 16
18	30	+ 33	+ 20
30	50	+ 41	+ 25
50	80	+ 49	+ 30

Clearance

Radial internal clearances of Roller Followers are based on Table 6.

Table 6 Radial internal clearance

unit: μm

Identification number ⁽¹⁾				Radial internal clearance	
Metric series			Inch series	Min.	Max.
Separable Roller Followers	Non-separable Roller Followers	Heavy Duty Type Roller Followers	Non-separable Roller Followers		
NAST 6R	NART 5R	-	-	5	20
NAST 8R ~ NAST12R	NART 6R ~ NART12R	-	-	5	25
NAST15R ~ NAST25R	NART15R ~ NART20R	-	-	10	30
NAST30R ~ NAST40R	NART25R ~ NART40R	-	-	10	40
NAST45R, NAST50R	NART45R, NART50R	-	-	15	50
-	-	NURT15R ~ NURT30-1R	-	20	45
-	-	NURT35R ~ NURT40-1R	-	25	50
-	-	NURT45R ~ NURT50-1R	-	30	60
-	-	-	CRY12R ~ CRY56R	35	60
-	-	-	CRY64R	45	70

Note⁽¹⁾ Also applicable to the full complement type, cylindrical outer ring type, shield type and sealed type.

Fit

Roller Followers are generally used under the loading conditions in which the load direction is fixed in relation to the inner ring and rotates in relation to the outer ring. The recommended fits for shafts are shown in Table 7. Those for the inch series are shown in the dimension table.

Table 7 Recommended fit (Metric series)

Type	Tolerance class of shaft
Separable Roller Followers	without inner ring
	with inner ring
Non-separable Roller Followers	g6, h6
Heavy Duty Type Roller Followers	

Maximum allowable static load

The load that is applicable to Roller Followers is, in some cases, determined by the strength of the outer ring rather than by the load rating of the needle roller bearing. Therefore, the maximum allowable load that is limited by the strength of outer ring is specified.

Track Capacity

Track capacity is defined as the load that can be continuously applied on a Roller Follower placed on a steel track surface without causing deformation and indentation on the track surface when the outer ring of the Roller Follower makes contact with the mating track surface (plane). The track capacities shown in Tables 8.1 and 8.2 are applicable when the hardness of the mating track surface is 40HRC (Tensile

strength 1250N/mm²). When the hardness of the mating track surface differs from 40HRC, the track capacity is obtained by multiplying the value by the track capacity factor shown in Table 9.

If lubrication between the outer ring and the mating track surface is insufficient, seizure and/or wear may occur depending on the application. Therefore, pay attention to lubrication and surface roughness of the mating track especially in the case of high-speed rotation such as for cam mechanisms.

unit: N

Table 8.1 Track capacity (Metric series)

Roller Followers with crowned outer ring				Roller Followers with cylindrical outer ring					
Identification number (1)			Track capacity	Identification number	Track capacity	Identification number (2)	Track capacity	Identification number	Track capacity
Separable Roller Followers	Non-separable Roller Followers	Heavy Duty Type Roller Followers							
RNAST 5R	NART 5R	—	1 040	RNAST 5	2 310	—	—	—	—
(R)NAST 6R	NART 6R	—	1 330	(R)NAST 6	3 550	NAST 6ZZ	3 550	—	—
(R)NAST 8R	NART 8R	—	1 850	(R)NAST 8	3 980	NAST 8ZZ	4 490	—	—
(R)NAST10R	NART10R	—	2 470	(R)NAST10	5 610	NAST10ZZ	6 890	—	—
(R)NAST12R	NART12R	—	2 710	(R)NAST12	5 990	NAST12ZZ	7 350	—	—
(R)NAST15R	NART15R	NURT15 R	3 060	(R)NAST15	6 550	NAST15ZZ	8 030	NURT15	11 500
—	—	NURT15-1R	3 910	—	—	—	—	NURT15-1	13 700
(R)NAST17R	NART17R	NURT17 R	3 660	(R)NAST17	10 900	NAST17ZZ	11 700	NURT17	13 600
—	—	NURT17-1R	4 530	—	—	—	—	NURT17-1	16 000
(R)NAST20R	NART20R	NURT20 R	4 530	(R)NAST20	12 800	NAST20ZZ	13 800	NURT20	20 000
—	—	NURT20-1R	5 190	—	—	—	—	NURT20-1	22 100
(R)NAST25R	NART25R	NURT25 R	5 190	(R)NAST25	14 100	NAST25ZZ	15 300	NURT25	22 100
—	—	NURT25-1R	6 580	—	—	—	—	NURT25-1	26 400
(R)NAST30R	NART30R	NURT30 R	6 580	(R)NAST30	22 100	NAST30ZZ	22 100	NURT30	31 600
—	—	NURT30-1R	8 020	—	—	—	—	NURT30-1	36 700
(R)NAST35R	NART35R	NURT35 R	8 020	(R)NAST35	25 700	NAST35ZZ	25 700	NURT35	36 700
—	—	NURT35-1R	9 220	—	—	—	—	NURT35-1	40 800
(R)NAST40R	NART40R	NURT40 R	9 220	(R)NAST40	26 900	NAST40ZZ	30 300	NURT40	44 200
—	—	NURT40-1R	10 800	—	—	—	—	NURT40-1	49 700
(R)NAST45R	NART45R	NURT45 R	9 990	(R)NAST45	28 500	NAST45ZZ	32 200	NURT45	47 000
—	—	NURT45-1R	12 400	—	—	—	—	NURT45-1	55 300
(R)NAST50R	NART50R	NURT50 R	10 800	(R)NAST50	30 200	NAST50ZZ	34 000	NURT50	49 700
—	—	NURT50-1R	14 000	—	—	—	—	NURT50-1	60 800

Notes(1) Also applicable to the full complement type, shield type, and sealed type.

(2) Also applicable to the sealed type.

Table 8.2 Track capacity (Inch series)

unit: N

Crowned outer ring		Cylindrical outer ring	
Identification number (1)	Track capacity	Identification number (1)	Track capacity
CRY12R	853	CRY12	4 490
CRY14R	1 050	CRY14	5 240
CRY16R	1 420	CRY16	7 270
CRY18R	1 660	CRY18	7 700
CRY20R	2 160	CRY20	10 700
CRY22R	2 450	CRY22	11 800
CRY24R	3 410	CRY24	15 400
CRY26R	3 820	CRY26	16 700
CRY28R	4 210	CRY28	21 000
CRY30R	4 610	CRY30	22 500
CRY32R	5 690	CRY32	30 800
CRY36R	6 640	CRY36	34 700
CRY40R	8 970	CRY40	44 900
CRY44R	10 200	CRY44	49 400
CRY48R	11 400	CRY48	64 300
CRY52R	12 700	CRY52	69 600
CRY56R	14 100	CRY56	87 000
CRY64R	16 800	CRY64	113 000

Note(1) Also applicable to the sealed type.

Table 9 Track capacity factor

Hardness HRC	Tensile strength N/mm ²	Track capacity factor	
		Crowned outer ring	Cylindrical outer ring
20	760	0.22	0.37
25	840	0.31	0.46
30	950	0.45	0.58
35	1 080	0.65	0.75
38	1 180	0.85	0.89
40	1 250	1.00	1.00
42	1 340	1.23	1.15
44	1 435	1.52	1.32
46	1 530	1.85	1.51
48	1 635	2.27	1.73
50	1 760	2.80	1.99
52	1 880	3.46	2.29
54	2 015	4.21	2.61
56	2 150	5.13	2.97
58	2 290	6.26	3.39

Allowable Rotational Speed

The allowable rotational speed of Roller Followers is affected by mounting and operating conditions. For reference, Table 10 shows dn values when only pure radial loads are applied. Under actual operating conditions, the recommended dn value is 1/10 of the value shown in the table in consideration of the axial loads that may act on the bearing.

Table 10 dn values of Roller Followers(1)

Type	Lubricant	
	Grease	Oil
Caged type	84 000	140 000
Full complement type	42 000	70 000
Heavy Duty Type Roller Follower	72 000	120 000

Note(1) dn value = $d \times n$
where, d : Bore diameter of bearing mm
 n : Rotational speed rpm

Lubrication

In Sealed Type Roller Followers, Heavy Duty Type Roller Followers and Inch series Roller Followers, ALVANIA GREASE S2 (SHELL) is prepacked as the lubricating grease.

For Roller Followers without prepacked grease, grease or oil should be supplied through the oil hole of the inner ring for use. If they are used without lubrication, wear of rolling contact surfaces may take place, leading to a short bearing life.

Oil Hole

Open Type Separable Roller Followers have no oil hole. Inner rings of other types of Metric series Roller Followers have an oil hole. Inch series inner rings have an oil groove and an oil hole.

Mounting

① In case of shield and sealed types, match the side surface correctly to the mating seating surface indicated by the dimension a shown in the dimension table, and fix them. (See Fig. 1.)

② When mounting Roller Followers, pay special attention to avoid locating the oil hole of the inner ring within the loading zone. This may lead to a short bearing life. (See Fig. 2.)

③ When mounting Sealed Type Separable Roller Followers, do not cause the side plates to come off. If they come off, set them again in place taking care to avoid damaging the seal lips.

④ In case of Roller Followers without an inner ring, the shaft requires heat treatment and grinding finish. The recommended surface hardness of the shaft is 58 ~ 64HRC, and the recommended roughness of the shaft is 0.2 $\mu\text{m}R_a$ or less.

Also, the outer ring and cage are guided by side surfaces of the mounting parts. Therefore, it is recommended that the side surfaces of the mounting parts be finished by grinding or at least by machining. (See Fig. 3.)

⑤ In Non-separable Roller Followers, the side plates are press-fitted. Therefore, when mounting the Roller Followers, do not push the side plates.

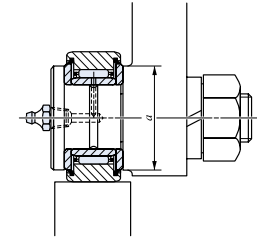

Fig. 1 Mating seating dimension "a"

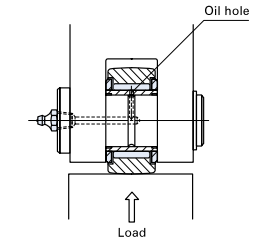

Fig. 2 Position of oil hole and load direction

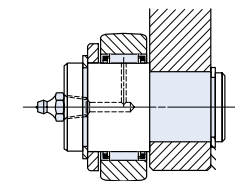
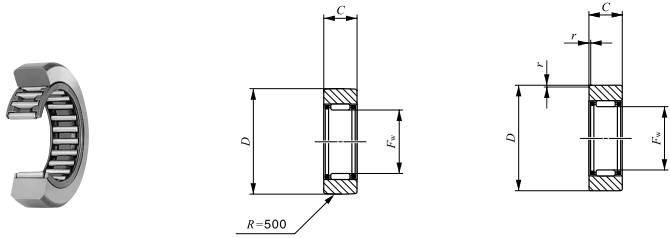

Fig. 3 Mounting example of Roller Follower without inner ring

1N=0.102kgf=0.2248lbs.
1mm=0.03937inch

ROLLER FOLLOWERS

Separable Roller Followers, Open Type **With Cage/Without Inner Ring**



Shaft dia. 7 60mm

RNAST...R

RNAST

Shaft dia. mm	Identification number		Mass (Ref.) g	Boundary dimensions mm					Basic dynamic load rating C N	Basic static load rating C ₀ N
	Open type			F _w	D	C	r _{s min} ⁽¹⁾			
	Crowned outer ring	Cylindrical outer ring								
7	RNAST 5 R	RNAST 5	8.9	7	16	7.8	0.3	2 710	2 390	
10	RNAST 6 R	RNAST 6	13.9	10	19	9.8	0.3	4 160	4 550	
12	RNAST 8 R	RNAST 8	23.5	12	24	9.8	0.6	5 650	5 890	
14	RNAST 10 R	RNAST 10	42.5	14	30	11.8	1	9 790	9 680	
16	RNAST 12 R	RNAST 12	49.5	16	32	11.8	1	10 500	10 900	
20	RNAST 15 R	RNAST 15	50	20	35	11.8	1	12 400	14 300	
22	RNAST 17 R	RNAST 17	90	22	40	15.8	1	17 600	20 900	
25	RNAST 20 R	RNAST 20	135	25	47	15.8	1	19 400	24 500	
30	RNAST 25 R	RNAST 25	152	30	52	15.8	1	20 800	28 400	
38	RNAST 30 R	RNAST 30	255	38	62	19.8	1	30 500	45 400	
42	RNAST 35 R	RNAST 35	375	42	72	19.8	1	32 400	50 600	
50	RNAST 40 R	RNAST 40	420	50	80	19.8	1.5	35 900	61 100	
55	RNAST 45 R	RNAST 45	460	55	85	19.8	1.5	37 400	66 400	
60	RNAST 50 R	RNAST 50	500	60	90	19.8	1.5	38 900	71 700	

Note⁽¹⁾ Minimum allowable value of chamfer dimension *r*

Remarks1. No oil hole is provided.

2. Not provided with prepacked grease. Perform proper lubrication for use.

Separable Roller Followers, Open Type **With Cage/With Inner Ring**

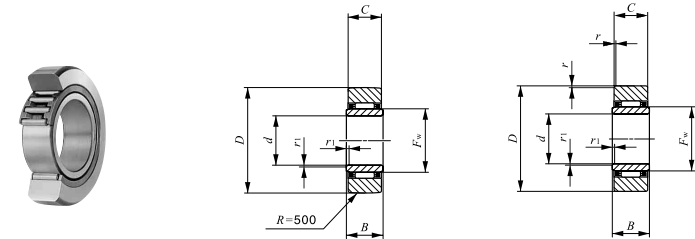

shaft dia. 6 – 50mm

NAST...R

NAST

Shaft dia. mm	Identification number		Mass (Ref.) g	Boundary dimensions mm							Basic dynamic load rating C N	Basic static load rating C ₀ N	Assembled inner ring
	Open type			d	D	B	C	r _{s min} ⁽¹⁾	r _{1s min} ⁽¹⁾	F _w			
	Crowned outer ring	Cylindrical outer ring											
6	NAST 6 R	NAST 6	17.8	6	19	10	9.8	0.3	0.3	10	4 160	4 550	LRT 61010 S
8	NAST 8 R	NAST 8	28	8	24	10	9.8	0.6	0.3	12	5 650	5 890	LRT 81210 S
10	NAST 10 R	NAST 10	49.5	10	30	12	11.8	1	0.3	14	9 790	9 680	LRT 101412 S
12	NAST 12 R	NAST 12	58	12	32	12	11.8	1	0.3	16	10 500	10 900	LRT 121612 S
15	NAST 15 R	NAST 15	62	15	35	12	11.8	1	0.3	20	12 400	14 300	LRT 152012 S
17	NAST 17 R	NAST 17	109	17	40	16	15.8	1	0.3	22	17 600	20 900	LRT 172216 S
20	NAST 20 R	NAST 20	157	20	47	16	15.8	1	0.3	25	19 400	24 500	LRT 202516 S
25	NAST 25 R	NAST 25	180	25	52	16	15.8	1	0.3	30	20 800	28 400	LRT 253016 S
30	NAST 30 R	NAST 30	320	30	62	20	19.8	1	0.6	38	30 500	45 400	LRT 303820 S
35	NAST 35 R	NAST 35	440	35	72	20	19.8	1	0.6	42	32 400	50 600	LRT 354220 S
40	NAST 40 R	NAST 40	530	40	80	20	19.8	1.5	1	50	35 900	61 100	LRT 405020 S
45	NAST 45 R	NAST 45	580	45	85	20	19.8	1.5	1	55	37 400	66 400	LRT 455520 S
50	NAST 50 R	NAST 50	635	50	90	20	19.8	1.5	1	60	38 900	71 700	LRT 506020 S

Note⁽¹⁾ Minimum allowable value of chamfer dimension *r* or *r*₁

Remarks1. No oil hole is provided.

2. Not provided with prepacked grease. Perform proper lubrication for use.

1N=0.102kgf=0.2248lbs.

1mm=0.03937inch

ROLLER FOLLOWERS

Separable Roller Followers, Shield Type **With Cage/With Inner Ring**
 Separable Roller Followers, Sealed Type **With Cage/With Inner Ring**

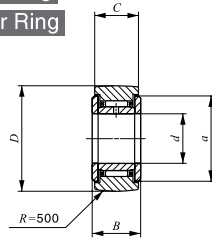

NAST...ZZR

Shaft dia. 6 – 50mm

Shaft dia. mm	Identification number				Mass (Ref.) g
	Shield type		Sealed type		
	Crowned outer ring	Cylindrical outer ring	Crowned outer ring	Cylindrical outer ring	
6	NAST 6 ZZR	NAST 6 ZZ	NAST 6 ZZUUR	NAST 6 ZZUU	24.5
8	NAST 8 ZZR	NAST 8 ZZ	NAST 8 ZZUUR	NAST 8 ZZUU	39
10	NAST 10 ZZR	NAST 10 ZZ	NAST 10 ZZUUR	NAST 10 ZZUU	65
12	NAST 12 ZZR	NAST 12 ZZ	NAST 12 ZZUUR	NAST 12 ZZUU	75
15	NAST 15 ZZR	NAST 15 ZZ	NAST 15 ZZUUR	NAST 15 ZZUU	83
17	NAST 17 ZZR	NAST 17 ZZ	NAST 17 ZZUUR	NAST 17 ZZUU	135
20	NAST 20 ZZR	NAST 20 ZZ	NAST 20 ZZUUR	NAST 20 ZZUU	195
25	NAST 25 ZZR	NAST 25 ZZ	NAST 25 ZZUUR	NAST 25 ZZUU	225
30	NAST 30 ZZR	NAST 30 ZZ	NAST 30 ZZUUR	NAST 30 ZZUU	400
35	NAST 35 ZZR	NAST 35 ZZ	NAST 35 ZZUUR	NAST 35 ZZUU	550
40	NAST 40 ZZR	NAST 40 ZZ	NAST 40 ZZUUR	NAST 40 ZZUU	710
45	NAST 45 ZZR	NAST 45 ZZ	NAST 45 ZZUUR	NAST 45 ZZUU	760
50	NAST 50 ZZR	NAST 50 ZZ	NAST 50 ZZUUR	NAST 50 ZZUU	830

Remarks1. The inner ring has an oil hole.
 2. The sealed type is provided with prepacked grease. The shield type is not provided with prepacked grease. Perform proper lubrication for use.

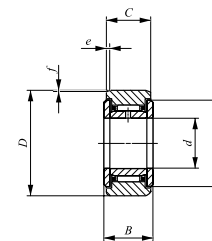

NAST...ZZ

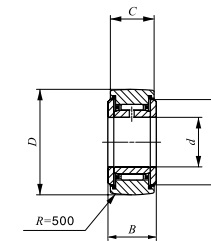

NAST...ZZUUR

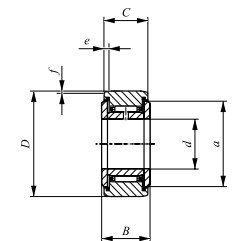

NAST...ZZUU

d	Boundary dimensions mm						Basic dynamic load rating C N	Basic static load rating C ₀ N
	D	B	C	a	e	f		
6	19	14	13.8	14	2.5	0.8	4 160	4 550
8	24	14	13.8	17.5	2.5	0.8	5 650	5 890
10	30	16	15.8	23.5	2.5	0.8	9 790	9 680
12	32	16	15.8	25.5	2.5	0.8	10 500	10 900
15	35	16	15.8	29	2.5	0.8	12 400	14 300
17	40	20	19.8	32.5	3	1	17 600	20 900
20	47	20	19.8	38	3	1	19 400	24 500
25	52	20	19.8	43	3	1	20 800	28 400
30	62	25	24.8	50.5	4	1.2	30 500	45 400
35	72	25	24.8	53.5	4	1.2	32 400	50 600
40	80	26	25.8	61.5	4	1.2	35 900	61 100
45	85	26	25.8	66.5	4	1.2	37 400	66 400
50	90	26	25.8	76	4	1.2	38 900	71 700

ROLLER FOLLOWERS

Non-separable Roller Followers **With Cage/With Inner Ring**

Full Complement Type/With Inner Ring

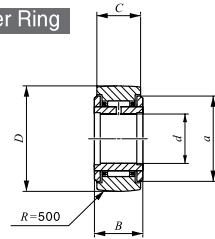

NART...R

Shaft dia. 5 – 40mm

Shaft dia. mm	Identification number				Mass (Ref.) g
	Shield type Crowned outer ring		Sealed type Crowned outer ring		
	With cage	Full complement	With cage	Full complement	
5	NART 5 R	—	NART 5 UUR	—	14.5
	—	NART 5 VR	—	NART 5 VUUR	15.1
6	NART 6 R	—	NART 6 UUR	—	20.5
	—	NART 6 VR	—	NART 6 VUUR	21.5
8	NART 8 R	—	NART 8 UUR	—	41.5
	—	NART 8 VR	—	NART 8 VUUR	42.5
10	NART 10 R	—	NART 10 UUR	—	64.5
	—	NART 10 VR	—	NART 10 VUUR	66.5
12	NART 12 R	—	NART 12 UUR	—	71
	—	NART 12 VR	—	NART 12 VUUR	73
15	NART 15 R	—	NART 15 UUR	—	102
	—	NART 15 VR	—	NART 15 VUUR	106
17	NART 17 R	—	NART 17 UUR	—	149
	—	NART 17 VR	—	NART 17 VUUR	155
20	NART 20 R	—	NART 20 UUR	—	250
	—	NART 20 VR	—	NART 20 VUUR	255
25	NART 25 R	—	NART 25 UUR	—	285
	—	NART 25 VR	—	NART 25 VUUR	295
30	NART 30 R	—	NART 30 UUR	—	470
	—	NART 30 VR	—	NART 30 VUUR	485
35	NART 35 R	—	NART 35 UUR	—	640
	—	NART 35 VR	—	NART 35 VUUR	655
40	NART 40 R	—	NART 40 UUR	—	845
	—	NART 40 VR	—	NART 40 VUUR	865

Remarks1. The inner ring has an oil hole.
2. The sealed type is provided with prepacked grease. The shield type is not provided with prepacked grease. Perform proper lubrication for use.

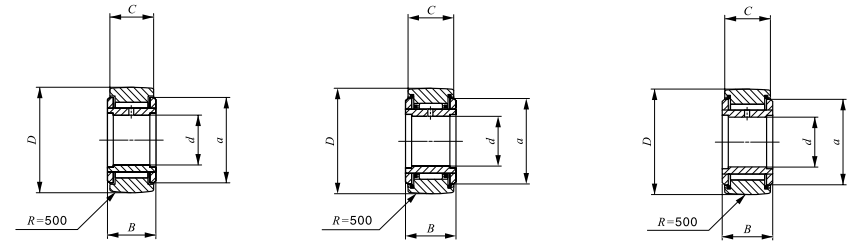

NART...VR

NART...UUR

NART...VUUR

Boundary dimensions mm					Basic dynamic load rating C N	Basic static load rating C ₀ N	Maximum allowable static load N
d	D	B	C	a			
5	16	12	11	12	3 650	3 680	3 680
5	16	12	11	12	6 810	8 370	7 310
6	19	12	11	14	4 250	4 740	4 740
6	19	12	11	14	7 690	10 300	10 300
8	24	15	14	17.5	5 640	5 900	5 900
8	24	15	14	17.5	11 800	15 600	15 600
10	30	15	14	23.5	8 030	7 540	7 540
10	30	15	14	23.5	15 600	18 100	17 500
12	32	15	14	25.5	8 580	8 470	8 470
12	32	15	14	25.5	16 800	20 500	18 600
15	35	19	18	29	13 700	16 400	16 400
15	35	19	18	29	25 200	36 400	24 000
17	40	21	20	32.5	17 600	21 000	21 000
17	40	21	20	32.5	32 000	46 300	33 100
20	47	25	24	38	23 000	30 700	30 700
20	47	25	24	38	41 600	67 300	67 300
25	52	25	24	43	24 700	35 400	35 400
25	52	25	24	43	45 500	79 100	79 100
30	62	29	28	50.5	33 600	51 400	51 400
30	62	29	28	50.5	59 900	110 000	92 500
35	72	29	28	53.5	35 700	57 400	57 400
35	72	29	28	53.5	63 100	121 000	121 000
40	80	32	30	61.5	44 900	81 500	81 500
40	80	32	30	61.5	76 300	164 000	164 000

1N=0.102kgf=0.2248lbs.
1mm=0.03937inch

ROLLER FOLLOWERS

Non-separable Roller Followers With Cage/With Inner Ring

Full Complement Type/With Inner Ring

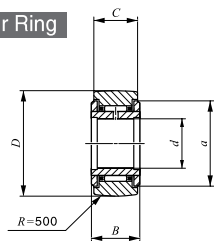

NART...R

Shaft dia. 45 – 50mm

Shaft dia. mm	Identification number				Mass (Ref.) g
	Shield type Crowned outer ring		Sealed type Crowned outer ring		
	With cage	Full complement	With cage	Full complement	
45	NART 45 R	—	NART 45 UUR	—	915
	—	NART 45 VR	—	NART 45 VUUR	935
50	NART 50 R	—	NART 50 UUR	—	980
	—	NART 50 VR	—	NART 50 VUUR	1 010

Remarks1. The inner ring has an oil hole.
2. The sealed type is provided with prepacked grease. The shield type is not provided with prepacked grease. Perform proper lubrication for use.

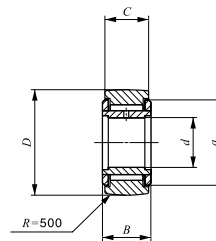

NART...VR

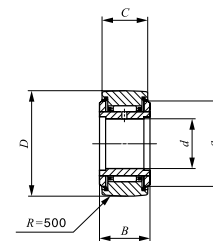

NART...UUR

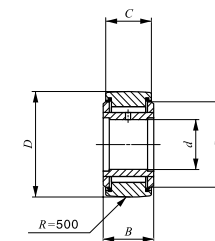

NART...VUUR

Boundary dimensions mm					Basic dynamic load rating C N	Basic static load rating C_0 N	Maximum allowable static load N
d	D	B	C	a			
45	85	32	30	66.5	46 800	88 600	88 600
45	85	32	30	66.5	80 300	181 000	181 000
50	90	32	30	76	48 600	95 600	95 600
50	90	32	30	76	84 300	198 000	198 000

I
NAST
NART
NURT

ROLLER FOLLOWERS

Heavy Duty Type Roller Followers Full Complement Type/With Inner Ring

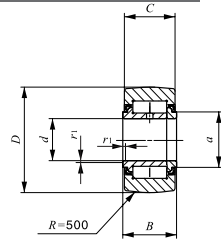

NURT...R

Shaft dia. 15 – 50mm

Shaft dia. mm	Identification number		Mass (Ref.) g	Boundary dimensions mm					
	Crowned outer ring	Cylindrical outer ring		d	D	B	C	a	$r_s \text{ min}^{(1)}$
15	NURT 15 R	NURT 15	100	15	35	19	18	20	0.6
	NURT 15-1 R	NURT 15-1	160	15	42	19	18	20	0.6
17	NURT 17 R	NURT 17	147	17	40	21	20	22	1
	NURT 17-1 R	NURT 17-1	222	17	47	21	20	22	1
20	NURT 20 R	NURT 20	245	20	47	25	24	27	1
	NURT 20-1 R	NURT 20-1	321	20	52	25	24	27	1
25	NURT 25 R	NURT 25	281	25	52	25	24	31	1
	NURT 25-1 R	NURT 25-1	450	25	62	25	24	31	1
30	NURT 30 R	NURT 30	466	30	62	29	28	38	1
	NURT 30-1 R	NURT 30-1	697	30	72	29	28	38	1
35	NURT 35 R	NURT 35	630	35	72	29	28	44	1
	NURT 35-1 R	NURT 35-1	840	35	80	29	28	44	1
40	NURT 40 R	NURT 40	817	40	80	32	30	49	1
	NURT 40-1 R	NURT 40-1	1 130	40	90	32	30	49	1
45	NURT 45 R	NURT 45	883	45	85	32	30	53	1
	NURT 45-1 R	NURT 45-1	1 400	45	100	32	30	53	1
50	NURT 50 R	NURT 50	950	50	90	32	30	58	1
	NURT 50-1 R	NURT 50-1	1 690	50	110	32	30	58	1

Note⁽¹⁾ Minimum allowable value of chamfer dimension r or r_1
 Remarks1. The inner ring has an oil hole.
 2. Provided with prepacked grease.

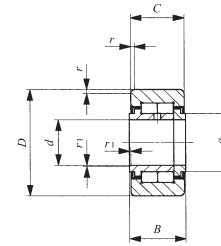

NURT

$r_s \text{ min}^{(1)}$	asic dynamic load rating C	asic static load rating C ₀	Maximum allowable static load
	N	N	N
0.3	23 400	27 300	11 800
0.3	23 400	27 300	27 300
0.3	25 200	30 900	20 300
0.3	25 200	30 900	30 900
0.3	38 900	49 000	27 200
0.3	38 900	49 000	49 000
0.3	43 100	58 100	30 000
0.3	43 100	58 100	58 100
0.3	58 200	75 300	35 200
0.3	58 200	75 300	75 300
0.6	63 900	88 800	57 000
0.6	63 900	88 800	88 800
0.6	86 500	122 000	75 300
0.6	86 500	122 000	122 000
0.6	91 500	135 000	78 700
0.6	91 500	135 000	135 000
0.6	96 300	148 000	82 100
0.6	96 300	148 000	148 000

1N=0.102kgf=0.2248lbs.
 1mm=0.03937inch

I
 NAST
 NURT
 NURT

TURNUP